



WARNING

THE FOLLOWING SERVICING INSTRUCTIONS ARE FOR USE BY QUALIFIED PERSONNEL ONLY. TO AVOID PERSONAL INJURY, DO NOT PERFORM ANY SERVICING OTHER THAN THAT CONTAINED IN OPERATING INSTRUCTIONS UNLESS YOU ARE QUALIFIED TO DO SO.

PLEASE CHECK FOR CHANGE INFORMATION AT THE REAR OF THIS MANUAL.

7904A OSCILLOSCOPE WITH OPTIONS

INSTRUCTION MANUAL

Tektronix, Inc.
P.O. Box 500
Beaverton, Oregon 97077

070-4593-00
Product Group 42

Serial Number: _____

First Printing MAY 1983
Revised MAY 1989

Copyright © 1983 Tektronix, Inc. All rights reserved.
Contents of this publication may not be reproduced in any
form without the written permission of Tektronix, Inc.

Products of Tektronix, Inc. and its subsidiaries are covered
by U.S. and foreign patents and/or pending patents.

TEKTRONIX, TEK, SCOPE-MOBILE, and  are
registered trademarks of Tektronix, Inc. TELEQUIPMENT
is a registered trademark of Tektronix U.K. Limited.

Printed in U.S.A. Specification and price change privileges
are reserved.

INSTRUMENT SERIAL NUMBERS

Each instrument has a serial number on a panel insert, tag,
or stamped on the chassis. The first number or letter
designates the country of manufacture. The last five digits
of the serial number are assigned sequentially and are
unique to each instrument. Those manufactured in the
United States have six unique digits. The country of
manufacture is identified as follows:

| | |
|----------------|---|
| B000000 | Tektronix, Inc., Beaverton, Oregon, USA |
| 100000 | Tektronix Guernsey, Ltd., Channel Islands |
| 200000 | Tektronix United Kingdom, Ltd., London |
| 300000 | Sony/Tektronix, Japan |
| 700000 | Tektronix Holland, NV, Heerenveen, The Netherlands |

TABLE OF CONTENTS

| PAGE | | PAGE |
|---|---|------|
| | LIST OF ILLUSTRATIONS | v |
| | LIST OF TABLES | vi |
| | OPERATORS SAFETY SUMMARY | vii |
| | | |
| SECTION 1—GENERAL INFORMATION | | |
| | TECHNICAL MANUALS | 1-1 |
| | INSTRUCTION MANUAL | 1-1 |
| | INSTALLATION | 1-1 |
| | INITIAL INSPECTION | 1-1 |
| | POWER SOURCE INFORMATION | 1-1 |
| | OPERATING VOLTAGE | 1-2 |
| | POWER CORD INFORMATION | 1-2 |
| | OPERATING TEMPERATURE | 1-3 |
| | OPERATING POSITION | 1-3 |
| | PACKAGING FOR SHIPMENT | 1-3 |
| | SPECIFICATION | 1-4 |
| | SYSTEM ELECTRICAL SPECIFICATION | 1-12 |
| | STANDARD ACCESSORIES | 1-15 |
| | OPTIONAL ACCESSORIES (NOT INCLUDED) | 1-15 |
| | | |
| SECTION 2—OPERATING INSTRUCTIONS | | |
| | PLUG-IN UNITS | 2-1 |
| | INSTALLATION OF PLUG-IN UNITS | 2-1 |
| | CONTROLS AND CONNECTORS | 2-1 |
| | FRONT-PANEL COLOR CODING | 2-1 |
| | OPERATORS CHECKOUT PROCEDURE | 2-1 |
| | TEST EQUIPMENT REQUIRED | 2-1 |
| | PRELIMINARY SETUP | 2-5 |
| | DISPLAY FOCUS | 2-5 |
| | TRACE ALIGNMENT | 2-5 |
| | GRATICULE ILLUMINATION | 2-5 |
| | CONTROL ILLUMINATION | 2-6 |
| | VERTICAL DEFLECTION SYSTEM | 2-6 |
| | HORIZONTAL DEFLECTION SYSTEM | 2-6 |
| | TRIGGERING | 2-7 |
| | READOUT | 2-7 |
| | BEAMFINDER | 2-7 |
| | CALIBRATOR | 2-8 |
| | Z-AXIS INPUT | 2-8 |
| | DETAILED OPERATING INFORMATION | 2-8 |
| | GRATICULE | 2-8 |
| | GRATICULE ILLUMINATION | 2-8 |
| | LIGHT FILTER | 2-8 |
| | CONTROL ILLUMINATION | 2-9 |
| | INTENSITY CONTROLS | 2-9 |
| | DISPLAY FOCUS | 2-9 |
| | ASTIGMATISM-FOCUS ADJUSTMENTS | 2-9 |
| | BEAMFINDER | 2-9 |
| | TRACE ALIGNMENT | 2-10 |
| | READOUT DISPLAY | 2-10 |
| | READOUT IDENTIFY | 2-10 |
| | READOUT INTENSITY | 2-10 |
| | READOUT MODES | 2-10 |
| | CARE OF CRT SCREEN | 2-11 |
| | OPERATING INSTRUCTIONS (CONT) | |
| | VERTICAL AND HORIZONTAL MODE | |
| | COMBINATIONS | 2-11 |
| | VERTICAL MODES | 2-11 |
| | ALTERNATE MODE | 2-11 |
| | CHOPPED MODE | 2-12 |
| | ALGEBRAIC ADDITION | 2-12 |
| | HORIZONTAL MODES | 2-12 |
| | ALTERNATE MODE | 2-13 |
| | CHOPPED MODE | 2-13 |
| | VERTICAL TRACE SEPARATION | 2-13 |
| | TRIGGER SOURCE | 2-13 |
| | CALIBRATOR OUTPUT | 2-13 |
| | VOLTAGE | 2-14 |
| | CURRENT | 2-14 |
| | REPETITION RATE | 2-14 |
| | WAVE SHAPE | 2-14 |
| | SIGNAL OUTPUTS | 2-14 |
| | + SAWTOOTH OUT | 2-14 |
| | + GATE OUT | 2-14 |
| | SIGNAL OUT | 2-14 |
| | PROBE POWER | 2-14 |
| | DISPLAY PHOTOGRAPHY | 2-14 |
| | INTENSITY MODULATION | 2-15 |
| | REMOTE INPUT SIGNALS | 2-15 |
| | REMOTE SINGLE SWEEP RESET | 2-15 |
| | REMOTE GRATICULE AND READOUT | |
| | SINGLE SHOT | 2-15 |
| | APPLICATIONS | 2-15 |
| | VERTICAL AMPLIFIER PLUG-IN UNITS | 2-15 |
| | SINGLE-TRACE | 2-15 |
| | DUAL-TRACE | 2-15 |
| | THREE-TRACE | 2-16 |
| | FOUR-TRACE | 2-16 |
| | TIME-BASE PLUG-IN UNITS | 2-16 |
| | SAMPLING DISPLAYS | 2-16 |
| | SINGLE-TRACE SAMPLING | 2-16 |
| | DUAL-TRACE SAMPLING | 2-16 |
| | X-Y SAMPLING | 2-16 |
| | SPECIAL PURPOSE PLUG-IN UNITS | 2-16 |
| | DIGITAL COUNTERS AND MULTIMETER | |
| | PLUG-IN UNITS | 2-16 |
| | PROGRAMMABLE DIGITIZER PLUG-IN | |
| | UNIT | 2-17 |
| | READOUT ACCESS PLUG-IN UNIT | 2-17 |
| | TRANSISTOR CURVE-TRACER PLUG-IN | |
| | UNITS | 2-17 |
| | SPECTRUM ANALYZER PLUG-IN UNITS | 2-17 |
| | X-Y OPERATION | 2-17 |
| | RASTER DISPLAYS | 2-18 |

WARNING

The remaining portion of this Table of Contents lists the servicing instructions by qualified personnel only. To avoid electrical shock, do not perform any servicing other than that called out in the Operating Instructions unless qualified to do so.

TABLE OF CONTENTS (CONT)

| | PAGE | | PAGE |
|---|------|---|------|
| SERVICING SAFETY SUMMARY | S1 | THEORY OF OPERATION (CONT) | |
| SECTION 3—THEORY OF OPERATION | | DISPLAY-SKIP GENERATOR | 3-33 |
| BLOCK DIAGRAM | 3-1 | COLUMN AND ROW DECODERS | 3-33 |
| DESCRIPTION | 3-1 | ZEROS LOGIC AND MEMORY | 3-34 |
| DETAILED CIRCUIT OPERATION | 3-3 | CHARACTER GENERATOR | 3-34 |
| LOGIC FUNDAMENTALS | 3-3 | DECIMAL POINT LOGIC AND CHARACTER | |
| SYMBOLS | 3-3 | POSITION COUNTER | 3-36 |
| LOGIC POLARITY | 3-3 | FORMAT GENERATOR | 3-37 |
| INPUT/OUTPUT TABLES | 3-3 | Y-OUTPUT | 3-37 |
| NON-DIGITAL DEVICES | 3-3 | X-OUTPUT | 3-37 |
| INTERCONNECTING DIAGRAM | 3-6 | DISPLAY SEQUENCE | 3-37 |
| MODE SWITCH, DISPLAY CONTROL AND | | READOUT SYSTEM (SN B031767 & Above) | 3-37 |
| CALIBRATOR | 3-6 | DISPLAY FORMAT | 3-37 |
| CALIBRATOR | 3-6 | DEVELOPING THE DISPLAY | 3-39 |
| MODE SWITCHING | 3-6 | TIMER | 3-41 |
| DISPLAY CONTROL | 3-6 | TIME-SLOT COUNTER | 3-44 |
| MAIN INTERFACE | 3-6 | WORD TRIGGER | 3-44 |
| LOGIC | 3-6 | CHANNEL COUNTER | 3-44 |
| HORIZONTAL LOGIC | 3-8 | SINGLE-SHOT LOCKOUT | 3-45 |
| A SWEEP LOCKOUT | 3-8 | ENCODING THE DATA | 3-45 |
| B SWEEP LOCKOUT STAGE | 3-8 | COLUMN AND ROW DATA SWITCHES | 3-46 |
| ALTERNATE PULSE GENERATOR | 3-9 | DISPLAY-SKIP GENERATOR | 3-47 |
| Z-AXIS LOGIC | 3-10 | COLUMN AND ROW DECODERS | 3-47 |
| HORIZONTAL BINARY | 3-11 | ZEROS LOGIC AND MEMORY | 3-47 |
| 1. A MODE | 3-11 | CHARACTER GENERATOR | 3-48 |
| 2. B MODE | 3-12 | HORIZONTAL CHARACTER POSITION COUNTER | 3-50 |
| 3. CHOP MODE | 3-12 | DECIMAL POSITION LOGIC | 3-50 |
| 4. ALT MODE | 3-12 | VECTOR GENERATORS | 3-51 |
| VERTICAL BINARY | 3-13 | OUTPUT AMPLIFIERS | 3-51 |
| 1. A OR B MODE | 3-13 | SIGNALS OUT & INTENSITY LIMITER | 3-51 |
| 2. ALT OR CHOP MODE (HORIZ): | | + SAWTOOTH AMPLIFIER | 3-51 |
| NONDELAYED | 3-13 | + GATE AMPLIFIER | 3-51 |
| 3. ALT OR CHOP MODE (HORIZ): | | END OF GATE PULSE GENERATOR | 3-51 |
| DELAYED | 3-13 | GRATICULE ILLUMINATION | 3-51 |
| PLUG-IN BINARY | 3-14 | INTENSITY LIMITER | 3-52 |
| VERTICAL CHOPPED BLANKING | 3-15 | VERTICAL CHANNEL SWITCH | 3-52 |
| CHOP COUNTER | 3-17 | CHANNEL SWITCH | 3-52 |
| VERTICAL MODE LOGIC | 3-19 | VERTICAL CHANNEL SELECTOR | 3-52 |
| TRACE SEPARATION | 3-19 | RIGHT AND LEFT CHANNEL FEEDBESIDE | 3-53 |
| SWEEP CONTROLLED Z-AXIS X-Y | 3-20 | VERTICAL AMPLIFIER | 3-53 |
| TRIGGER SELECTOR | 3-22 | DELAY-LINE | 3-53 |
| A AND B TRIGGER CHANNELS SWITCHES | 3-22 | DELAY-LINE COMPENSATION | 3-53 |
| A TRIGGER CHANNEL SWITCH | 3-22 | FEEDBESIDE | 3-53 |
| A AND B TRIGGER AMPLIFIER | 3-22 | OUTPUT AMPLIFIER | 3-54 |
| VERTICAL SIGNAL OUTPUT AMPLIFIER | 3-22 | OUTPUT PROTECTION | 3-54 |
| READOUT SYSTEM (SN B031766 & Below) | 3-23 | AUXILIARY AMPLIFIER | 3-54 |
| DISPLAY FORMAT | 3-23 | HORIZONTAL INTERFACE | 3-54 |
| DEVELOPING THE DISPLAY | 3-25 | CHANNEL SWITCH | 3-55 |
| TIMER | 3-27 | X-Y DELAY COMPENSATION (OPTION 2) | 3-55 |
| TIME-SLOT COUNTER | 3-29 | TIME-BASE OPERATION | 3-55 |
| WORD TRIGGER | 3-29 | X-Y OPERATION | 3-55 |
| CHANNEL COUNTER | 3-30 | HORIZONTAL AMPLIFIER | 3-55 |
| SINGLE-SHOT LOCKOUT | 3-30 | INPUT AMPLIFIER | 3-55 |
| ENCODING THE DATA | 3-30 | DRIVER AMPLIFIERS AND ACTIVE PEAKING | 3-56 |
| COLUMN AND ROW DATA SWITCHES | 3-33 | OUTPUT AMPLIFIER | 3-56 |
| | | Z-AXIS AND FOCUS AMPLIFIER | 3-56 |
| | | Z-AXIS AMPLIFIER | 3-57 |

TABLE OF CONTENTS (CONT)

| | PAGE | | PAGE |
|---|------|--|------|
| THEORY OF OPERATION | | MAINTENANCE (CONT) | |
| AUTO-FOCUS CHANNEL SWITCH AND AMPLIFIER | 3-57 | TROUBLESHOOTING TECHNIQUES | 4-7 |
| HIGH-VOLTAGE POWER SUPPLY AND CRT | 3-57 | 1. CHECK CONTROL SETTINGS | 4-7 |
| POWER TRANSFORMER | 3-57 | 2. CHECK ASSOCIATED EQUIPMENT | 4-7 |
| +130 V SUPPLY | 3-57 | 3. VISUAL CHECK | 4-7 |
| CRT HEATER | 3-57 | 4. CHECK INSTRUMENT ADJUSTMENT | 4-7 |
| ANODE VOLTAGE MULTIPLIER | 3-57 | 5. ISOLATE TROUBLE TO A CIRCUIT | 4-7 |
| CRT CATHODE SUPPLY | 3-58 | 6. CHECK VOLTAGES AND WAVEFORMS | 4-8 |
| CATHODE SUPPLY REGULATOR | 3-58 | 7. CHECK INDIVIDUAL COMPONENTS | 4-8 |
| CONTROL-GRID DC RESTORER | 3-58 | FUSES | 4-8 |
| FOCUS-GRID DC RESTORER | 3-58 | TRANSISTORS | 4-8 |
| CRT CONTROL | 3-58 | INTEGRATED CIRCUITS | 4-8 |
| CONVERTER/RECTIFIERS | 3-58 | DIODES | 4-8 |
| LINE INPUT | 3-59 | RESISTORS | 4-8 |
| INVERTER START | 3-59 | CAPACITORS | 4-8 |
| INVERTER | 3-60 | 8. REPAIR AND ADJUST THE CIRCUIT | 4-8 |
| OVER-VOLTAGE STOP | 3-60 | TROUBLESHOOTING THE HIGH-EFFICIENCY | |
| INVERTER CONTROL | 3-60 | POWER-SUPPLY UNIT | 4-9 |
| PRE-REGULATOR | 3-62 | GENERAL | 4-9 |
| FAULT PROTECTION | 3-62 | PRELIMINARY PROCEDURE | 4-9 |
| INVERTER CURRENT LIMITER | 3-62 | TROUBLESHOOTING PROCEDURE | 4-9 |
| FAULT SENSE | 3-62 | STEP A: CHECK LINE FUSE | 4-9 |
| LINE STOP | 3-63 | STEP B: ISOLATE POWER SUPPLY | |
| LOW-VOLTAGE RECTIFIERS | 3-63 | MALFUNCTION FROM THE MAINFRAME | |
| LOW-VOLTAGE REGULATORS AND FAN | 3-63 | CIRCUITRY | 4-10 |
| OPERATIONAL AMPLIFIER POWER | | STEP C: CHECK THE PRE-REGULATED | |
| SUPPLIES | 3-63 | POWER SUPPLIES | 4-10 |
| +50 V REGULATOR | 3-63 | STEP D: CHECK LINE INPUT CIRCUIT | 4-11 |
| -15 V REGULATOR | 3-64 | STEP E: CHECK CRT AND HIGH-VOLTAGE | |
| +5 V REGULATOR | 3-64 | CIRCUIT | 4-12 |
| +15 V REGULATOR | 3-64 | STEP F: CHECK THE INVERTER CONTROL | |
| -50 V REGULATOR | 3-64 | CIRCUIT | 4-12 |
| FAN CIRCUIT | 3-64 | STEP G: CHECK INVERTER CIRCUIT | 4-12 |
| GRATICULE LIGHT SUPPLY | 3-64 | STEP H: CHECK LV RECTIFIER CIRCUIT | 4-13 |
| | | CORRECTIVE MAINTENANCE | 4-14 |
| SECTION 4—MAINTENANCE | | OBTAINING REPLACEMENT PARTS | 4-14 |
| PREVENTIVE MAINTENANCE | 4-1 | SPECIAL PARTS | 4-14 |
| CABINET PANEL REMOVAL | 4-1 | ORDERING PARTS | 4-14 |
| CLEANING | 4-1 | SOLDERING TECHNIQUES | 4-14 |
| EXTERIOR | 4-1 | COMPONENT REMOVAL AND REPLACEMENT | 4-15 |
| CRT | 4-1 | DISPLAY UNIT KICKSTAND | 4-15 |
| INTERIOR | 4-2 | POWER-SUPPLY UNIT REMOVAL | 4-15 |
| VISUAL INSPECTION | 4-2 | ACCESS TO COMPONENTS IN THE POWER- | |
| SEMICONDUCTOR CHECKS | 4-2 | SUPPLY UNIT | 4-16 |
| PERIODIC ELECTRICAL ADJUSTMENT | 4-2 | CATHODE-RAY TUBE REMOVAL | 4-17 |
| TROUBLESHOOTING | 4-3 | CATHODE-RAY TUBE REPLACEMENT | 4-18 |
| TROUBLESHOOTING AIDS | 4-3 | CIRCUIT BOARDS | 4-18 |
| DIAGRAMS | 4-3 | CHASSIS-MOUNTED BOARDS | 4-18 |
| CIRCUIT BOARD ILLUSTRATIONS | 4-3 | PLUG-ON BOARDS | 4-18 |
| ADJUSTMENT AND TEST POINT LOCATIONS | 4-3 | A5-MODE SWITCH CIRCUIT BOARD | 4-18 |
| COMPONENT COLOR CODING | 4-3 | A6-MAIN INTERFACE CIRCUIT BOARD | 4-19 |
| SEMICONDUCTOR LEAD CONFIGURATIONS | 4-3 | A7/A8/A9/A10/A25/A26-FOLLOWER CIRCUIT | |
| STATIC-SENSITIVE DEVICES | 4-3 | BOARDS | 4-19 |
| MULTI-PIN CONNECTORS | 4-6 | A11-FAN MOTOR CIRCUIT BOARD | 4-20 |
| TROUBLESHOOTING EQUIPMENT | 4-6 | A22-LOW-VOLTAGE REGULATOR CIRCUIT | |
| | | BOARD | 4-20 |

TABLE OF CONTENTS (CONT)

| | PAGE | | PAGE |
|---|------|---|----------|
| A12-CONTROL RECTIFIER CIRCUIT BOARD | 4-22 | SECTION 6—INSTRUMENT OPTIONS | |
| A23-POWER SUPPLY INVERTER CIRCUIT BOARD | 4-22 | OPTION 2 | 6-1 |
| PLUG-IN INTERFACE CONNECTORS | 4-22 | OPTION 3 | 6-1 |
| DELAY LINE REMOVAL | 4-23 | OPTION 4 | 6-1 |
| SEMICONDUCTORS | 4-23 | OPTION 13 | 6-1 |
| HYPCON CONNECTORS | 4-23 | OPTION 78 | 6-1 |
| INTERCONNECTING PINS | 4-27 | OPTION A1 | 6-1 |
| COAXIAL-TYPE END-LEAD CONNECTORS | 4-27 | OPTION A2 | 6-1 |
| CIRCUIT-BOARD PINS | 4-27 | OPTION A3 | 6-1 |
| CIRCUIT-BOARD PIN SOCKETS | 4-27 | OPTION A4 | 6-1 |
| MULTI-PIN CONNECTORS | 4-28 | OPTION A5 | 6-1 |
| PUSHBUTTON SWITCHES | 4-28 | INSTRUMENT OPTION IDENTIFICATION | 6-1 |
| GRATICULE LIGHT BULBS | 4-28 | | |
| POWER TRANSFORMER | 4-28 | | |
| LINE FUSE | 4-30 | | |
| ADJUSTMENT AFTER REPAIR | 4-30 | | |
| | | SECTION 7—REPLACEABLE ELECTRICAL PARTS | |
| SECTION 5—CHECKS AND ADJUSTMENT | | | |
| USING THESE PROCEDURES | 5-1 | SECTION 8—DIAGRAMS AND CIRCUIT BOARD ILLUSTRATIONS | |
| PERFORMANCE CHECK SUMMARY | 5-2 | | |
| ADJUSTMENT INTERVAL | 5-11 | | DIAGRAMS |
| TEKTRONIX FIELD SERVICE | 5-11 | INTERCONNECTING DIAGRAM | 1 |
| TEST EQUIPMENT REQUIRED | 5-11 | MODE SWITCH, DISPLAY CONTROL & CALIBRATOR | 2 |
| SPECIAL FIXTURES | 5-11 | MAIN INTERFACE | 3 |
| TEST EQUIPMENT ALTERNATIVES | 5-11 | LOGIC | 4 |
| PART I—PERFORMANCE CHECK | 5-14 | TRIGGER SELECTOR | 5 |
| INDEX TO PERFORMANCE CHECK PROCEDURE | 5-14 | READOUT SYSTEM (SN B031767 & ABOVE) | 6 |
| PERFORMANCE CHECK POWER-UP SEQUENCE | 5-14 | READOUT SYSTEM (SN B031766 & BELOW) | 6 |
| A. Z-AXIS AND DISPLAY | 5-15 | SIGNALS OUT & INTENSITY LIMITER | 7 |
| B. CALIBRATOR AND OUTPUT SIGNALS | 5-16 | VERTICAL CHANNEL SWITCH | 8 |
| C. TRIGGER SYSTEM | 5-21 | VERTICAL AMPLIFIER | 9 |
| D. HORIZONTAL SYSTEM | 5-23 | HORIZONTAL INTERFACE | 10 |
| E. VERTICAL SYSTEM | 5-26 | HORIZONTAL AMPLIFIER | 11 |
| F. READOUT SYSTEM | 5-31 | Z-AXIS & FOCUS AMPLIFIER | 12 |
| PART II—ADJUSTMENT AND PERFORMANCE CHECK | 5-33 | HIGH-VOLTAGE POWER SUPPLY & CRT | 13 |
| INDEX TO ADJUSTMENT AND PERFORMANCE CHECK PROCEDURE | 5-33 | CONVERTER/RECTIFIER | 14 |
| ADJUSTMENT AND PERFORMANCE CHECK POWER-UP SEQUENCE | 5-34 | LOW-VOLTAGE REGULATORS & FAN | 15 |
| A. POWER SUPPLY | 5-35 | | |
| B. Z-AXIS AND DISPLAY | 5-38 | SECTION 9—REPLACEABLE MECHANICAL PARTS | |
| C. CALIBRATOR AND OUTPUT SIGNALS | 5-45 | | |
| D. TRIGGER SYSTEM | 5-50 | CHANGE INFORMATION | |
| E. HORIZONTAL SYSTEM | 5-55 | | |
| F. VERTICAL SYSTEM | 5-61 | | |
| G. READOUT SYSTEM (SN B031766 & BELOW) | 5-69 | | |
| G. READOUT SYSTEM (SN B031767 & ABOVE) | 5-72 | | |

LIST OF ILLUSTRATIONS

| Figure No | Page | Figure No | Page |
|-----------|---|--------------------------------------|---|
| | 7904A Features | 4-1 | Color code for resistors and capacitors |
| 1-1 | 7904A Dimensional Drawing | 4-2 | Semiconductor lead configurations |
| 2-1 | Front-panel controls, connectors and indicators | 4-3 | Orientation of multi-pin connectors |
| 2-2 | Rear-panel controls and connectors | 4-4 | Current sensing waveform at A12R84 |
| 2-3 | Definition of graticule measurement lines | 4-5 | Location of screws for discharging line storage capacitors |
| 2-4 | Location of readout on the crt identifying the originating plug-in and channel | 4-6 | Current waveform of A23T30 showing burst operation at line voltage of about 60 volts |
| 2-5 | Typical Setup for X-Y Displays with Z-Axis Control from time-base unit | 4-7 | Current waveform at A23T30 for normal inverter operation at line voltage of 115 volts |
| 2-6 | Typical X-Y Displays with and without Z-Axis Control | 4-8 | Waveform at IP34 on the A23 Power Supply Inverter circuit board with the line-voltage at about 20 volts |
| 3-1 | Basic block diagram of the 7904A Oscilloscope | 4-9 | Recommended desoldering sequence |
| 3-2 | Breakdown of separate stages within Horizontal Logic IC (U4428) | 4-10 | Use of Display Unit kickstand |
| 3-3 | (A) Diagram of clock generator stage; (B) Idealized waveforms for clock generator stage | 4-11 | Power supply unit securing screws |
| 3-4 | Idealized waveforms for the Vertical Chopped Blanking IC (U4320) | 4-12 | Location of securing screws for the A6-Main Interface board |
| 3-5 | (A) Input and output pins for Chop Counter IC, U4340; (B) Idealized waveforms for Chop Counter stage | 4-13 | Correct placement of power transistor and mounting hardware on rear heatsink |
| 3-6 | Logic diagram of Vertical Mode Logic stage | 4-14 | HYPCON assembly removal and replacement |
| 3-7 | (A) Logic diagram of Trace Separation stage; (B) Table of input/output combinations | 4-15 | Coaxial end-lead connector assembly |
| 3-8 | Location of readout display on the crt identifying the originating plug-in and channel | 4-16 | Exploded view of circuit-board pin and ferrule |
| 3-9 | Character selection matrix for 7904A Readout System (SN B031766 & Below) | 4-17 | Removal procedure for pushbutton switches mounted on the A5 Mode Switch board |
| 3-10 | Typical readout display where only channel 2 (of the Right Vertical and B Horizontal units) is displayed | 5-1 | Typical display when checking X-Y phase compensation |
| 3-11 | Output waveforms of the Timer stage | 5-2 | Readout display with Q2225 removed |
| 3-12 | Detail of output at pins 12, 13, 14 and 16 of U2126 | 5-3 | Typical display when checking X-Y phase compensation |
| 3-13 | Timer stage operation when display-skip condition occurs | 5-4 | Readout display with Q2225 removed |
| 3-14 | Timer relationship of the time-slot (TS) pulses produced by U2159 | diagrams on the foldout page. | |
| 3-15 | Typical encoding scheme for voltage-sensing plug-in unit. Coding shown for deflection factor of 100 microvolts | 8-1 | 7904A board locator drawing. |
| 3-16 | Idealized current waveforms of (A) Row analog data and (B) Column analog data | 8-2 | Semiconductor lead configurations. |
| 3-17 | Typical output waveforms for Zeros Logic and Memory stage operation (at pin 7 of U2232) | 8-3 | A5-Mode Switch circuit board assembly. |
| 3-18 | Readout word relating 10 possible character locations to the decimal point instructions that can be encoded; and the resultant crt display | 8-4 | A2-Display Control circuit board assembly. |
| 3-19 | Flow chart for character generation by the Readout System | 8-5 | A6-Main Interface circuit board assembly. |
| 3-20 | Character selection matrix for 7904A Readout System (SN B031767 & Above) | 8-6 | A13-Logic circuit board assembly. |
| 3-21 | Detailed block diagram of the Readout System (SN B031767 & Above) | 8-7 | A14-Trigger Selector circuit board assembly. |
| 3-22 | Developing a typical character on the CRT | 8-8 | A15-Readout System circuit board assembly. |
| 3-23 | Detailed block diagram of the Converter/Rectifiers circuit | 8-9 | A27-Readout Protection circuit board assembly. |
| 3-24 | (A) Representation of Inverter stage. Idealized waveforms of (B) total Inverter current, I_T , (C) Voltage across CR41 and (D) Voltage across primaries of T110 and T35 | 8-10 | A1-Front Panel circuit board assembly. |
| | | 8-11 | A16-Vertical Channel Switch circuit board assembly. |
| | | 8-12 | A18-Vertical Amplifier circuit board assembly. |
| | | 8-13 | A29-Horizontal Interface circuit board assembly. |
| | | 8-14 | A17-X-Y Delay Compensation (Option 2) circuit board assembly. |
| | | 8-15 | A28-Horizontal Amplifier circuit board assembly. |
| | | 8-16 | A21-Z-Axis circuit board assembly. |
| | | 8-17 | A20-High Voltage circuit board assembly. |
| | | 8-18 | A23-Power Supply circuit board assembly. |
| | | 8-19 | A12-Control Rectifier circuit board assembly. |
| | | 8-20 | A22-Low Voltage circuit board assembly. |
| | | 8-21 | A11-Fan circuit board assembly. |
| | | 8-22 | Test Point and Adjustment Locations A. |
| | | 8-23 | Test Point and Adjustment Locations B. |
| | | 8-24 | Adjustment Locations C. |
| | | 8-25 | Adjustment Locations D. |
| | | 8-26 | Test Point and Adjustment Locations E. |
| | | 8-27 | Test Point and Adjustment Locations F. |
| | | 8-28 | Test Point and Adjustment Locations G. |

LIST OF TABLES

| Table No | Page | Table No | Page |
|---------------------|--|---------------------|---|
| 1-1 | Power-Cord Color Conductor Identification | 3-9 | Input/Output Combinations for the Plug-In Binary Stage |
| 1-2 | Power-Cord and Plug Identification Information | 3-10 | Input/Output Combinations for the Vertical Chopped Blanking Stage |
| 1-3 | Electrical Characteristics | 3-11 | Standard Readout Format |
| 1-4 | Environmental Characteristics | 3-12 | Channel Address Code (SN B031766 & Below) |
| 1-5 | Physical Characteristics | 3-13 | Channel Address Code (SN B031767 & Above) |
| 1-6 | Plug-In Incompatibilities | 3-14 | Input/Output Relationships for the Auto-Focus Channel Switch |
| 1-7 | 7904A Oscilloscope Vertical System Specification | 4-1 | Relative Susceptibility To Static Discharge Damage |
| 1-8 | 7904A Oscilloscope Horizontal System Specification | 4-2 | Recommended Power Supply Troubleshooting Sequence |
| 1-9 | Special Purpose Plug-In Units | 4-3 | Typical Power-Supply Resistance |
| 2-1 | Display Combinations | 4-4 | Burst Voltage Test Points |
| 3-1 | Basic Logic Symbols | 5-1 | Checks and Adjustment Procedure Electives |
| 3-2 | Mode Switching Inputs/Output | 5-2 | Performance Check Summary |
| 3-3 | Input/Output Combinations for A Lockout (U4428 Pin 14) | 5-3 | Test Equipment |
| 3-4 | Input/Output Combinations for B Lockout (U4428 Pin 15) | 5-4 | Power Supply Tolerances |
| 3-5 | Input/Output Combinations for Alternate Pulse (U4428 Pin 8) | 5-5 | Thermal Compensation Adjustments |
| 3-6 | Input/Output Combinations for the Z-Axis Logic Stage | 5-6A | Right Channel-Switch Compensation (Signal Rep Rate vs: Sweep Rate) |
| 3-7 | Input/Output Combinations of the Horizontal Binary Stage | 5-6B | Left Channel-Switch Compensation (Signal Rep Rate vs: Sweep Rate) |
| 3-8 | Input/Output Combinations for the Vertical Binary Stage | 5-7 | High-Frequency Compensation Adjustment |
| | | 6-1 | Option Information Locator |

OPERATORS SAFETY SUMMARY

The general safety information in this part of the summary is for both operating and servicing personnel. Specific warnings and cautions will be found throughout the manual where they apply, but may not appear in this summary.

TERMS

IN THIS MANUAL

CAUTION statements identify conditions or practices that could result in damage to the equipment or other property.

WARNING statements identify conditions or practices that could result in personal injury or loss of life.

AS MARKED ON EQUIPMENT

CAUTION indicates a personal injury hazard not immediately accessible as one reads the marking, or a hazard to property including the equipment itself.

DANGER indicates a personal injury hazard immediately accessible as one reads the marking.

SYMBOLS

IN THIS MANUAL

 Static-Sensitive Devices

 This symbol indicates where applicable cautionary or other information is to be found.

AS MARKED ON EQUIPMENT

 **DANGER**—High voltage.

 Protective ground (earth) terminal.

 **ATTENTION**—Refer to manual.

WARNINGS

POWER SOURCE

This product is intended to operate from a power source that will not apply more than 250 volts rms between the supply conductors or between either supply conductor and ground. A protective ground connection, by way of the grounding conductor in the power cord is essential for safe operation.

GROUNDING THE PRODUCT

This product is grounded through the grounding conductor of the mainframe power cord. To avoid electrical shock, plug the mainframe power cord into a properly wired receptacle before connecting to the product input or output terminals. A protective-ground connection by way of the grounding conductor in the mainframe power cord is essential for safe operation.

DANGER ARISING FROM LOSS OF GROUND

Upon loss of the protective-ground connection, all accessible conductive parts (including knobs and controls that may appear to be insulating), can render an electric shock.

DO NOT OPERATE IN EXPLOSIVE ATMOSPHERES

To avoid explosion, do not operate this product in an atmosphere of explosive gasses.

DO NOT REMOVE COVERS OR PANELS

To avoid personal injury, do not remove the product covers or panels. Do not operate the product without the covers and panels properly installed.

DO NOT OPERATE WITHOUT COVERS

To avoid personal injury, do not operate this product without covers or panels installed.

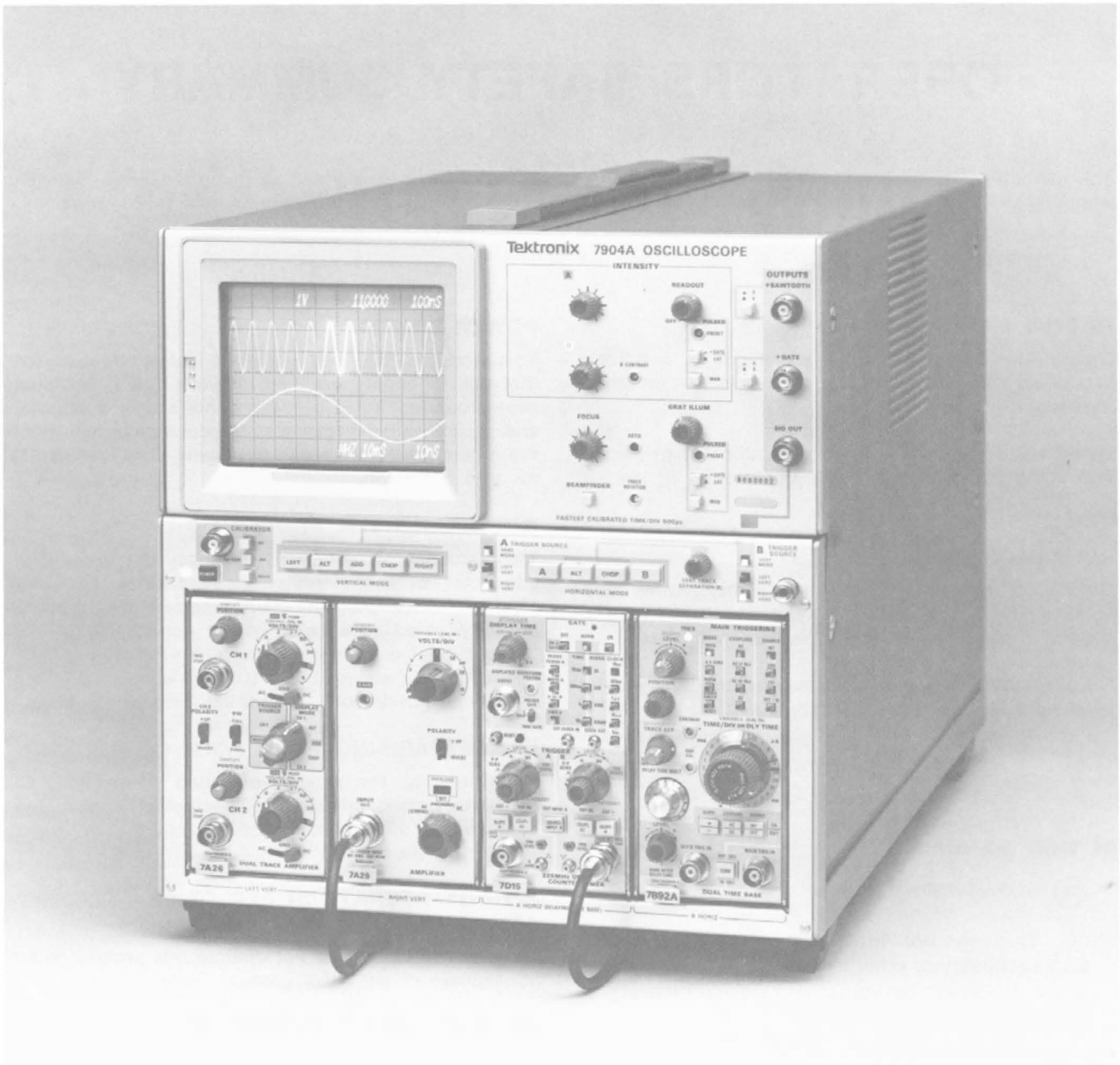

4593-3

7904A FEATURES

The TEKTRONIX 7904A Oscilloscope is a solid-state, high performance (500 MHz vertical bandwidth) instrument designed for general purpose applications.

The 7904A accepts four 7000-series plug-in units to form a highly flexible oscilloscope system. The left pair of plug-in compartments are for vertical deflection and the right pair of plug-in compartments are for horizontal deflection. Electronic switching between each deflection system allows dual-trace vertical and dual-sweep horizontal displays.

The 7904A features include an 8 cm × 10 cm crt display area with a crt readout display of alphanumeric characters from the associated plug-in units. The readout display includes deflection factor, sweep rate, and other encoded parameters.

The above delayed-sweep display was obtained using a 7B92A Dual Time Base. An 11 megahertz sine-wave signal was applied simultaneously to the 7A29 Input and to the 7D15 Freq In connectors. The input frequency is monitored and continuously updated on the 7904A crt readout display. The 7A26 Dual Trace Amplifier provides additional vertical display capabilities when selected.

GENERAL INFORMATION

This section is the first place to look for information on your 7904A Oscilloscope. First we describe the features of the 7904A and the basic content of the instruction manual. Next we describe installation, power source and power cord requirements, operating temperature considerations, instrument repair services, and packaging for shipment instructions. We also include the electrical, environmental, and physical specification of the 7904A, list compatibility information for plug-in units, and provide a list of standard and recommended accessories.

TECHNICAL MANUALS

An instruction manual is shipped as a standard accessory to the 7904A Oscilloscope.

INSTRUCTION MANUAL

The 7904A Instruction Manual contains the information necessary to operate and service your instrument. The content of the instruction manual is described as follows:

Section 1—General Information contains instrument description, electrical specifications, environmental characteristics, standard and optional accessories, installation, and packaging for shipment instructions.

Section 2—Operating Instructions contains information relative to operating and checking the instrument operation.

WARNING

THE FOLLOWING SERVICING INSTRUCTIONS ARE FOR USE BY QUALIFIED PERSONNEL ONLY. TO AVOID PERSONAL INJURY, DO NOT PERFORM ANY SERVICING OTHER THAN THAT CONTAINED IN OPERATING INSTRUCTIONS UNLESS YOU ARE QUALIFIED TO DO SO. REFER TO OPERATORS AND SERVICING SAFETY SUMMARIES PRIOR TO PERFORMING ANY SERVICE.

Section 3—Theory of Operation contains basic and general circuit analysis that may be useful for servicing or operating the instrument.

Section 4—Maintenance describes routine and corrective maintenance procedures with detailed instructions for replacing assemblies, subassemblies, and individual components.

Section 5—Checks and Adjustment contains procedures to check the electrical characteristics of

the instrument. Procedures are also provided for adjustment of the instrument to meet specifications.

Section 6—Instrument Options contains a description of available options and locations of incorporated information for those options.

Section 7—Replaceable Electrical Parts contains information necessary to order replaceable parts and assemblies related to the electrical functions of the instrument.

Section 8—Diagrams and Circuit Board Illustrations includes detailed circuit schematics, locations of assembled boards within the instrument, voltage and waveform information, circuit board component locators, and locations of adjustments to aid in performing the Checks and Adjustment section of this manual.

Section 9—Replaceable Mechanical Parts includes information necessary to order replaceable mechanical parts and shows exploded drawings which identify assemblies.

INSTALLATION

INITIAL INSPECTION

This instrument was inspected both mechanically and electrically before shipment. It should be free of marks or scratches and meet or exceed all electrical specifications. To confirm this, inspect the instrument for physical damage incurred in transit and test the electrical performance by following the Operating Checkout Procedure in Section 2, Operating Instructions. Verify Performance Requirements by referring a qualified service person to the servicing sections of the Instruction Manual. If there is damage or deficiency, contact your local Tektronix Field Office or representative.

POWER SOURCE INFORMATION

This instrument can be operated from either a 115-volt or 230-volt nominal supply source, 48 to 440 hertz. The

General Information—7904A

line fuse remains the same for both 115-volt and 230-volt operation.

Operating Voltage

The LINE VOLTAGE SELECTOR switch (located on the rear of the 7904A Oscilloscope mainframe) allows selection of 115-volt or 230-volt nominal line voltage operation. To select the correct nominal line voltage, first change the power cord and plug to match the power-source receptacle (if necessary). Then, use a small screwdriver to move the LINE VOLTAGE SELECTOR switch to the desired range.

CAUTION

To prevent damage to the instrument, always check the settings of the LINE VOLTAGE SELECTOR switch located on the rear panel of the 7904A Oscilloscope mainframe before connecting the instrument to the line-voltage source.



Power Cord Information

A power cord with the appropriate plug configuration is supplied with each instrument. For your convenience the color-coding of the power cord conductors is given in Table 1-1. Also, should you require a power-cord plug other than that supplied, refer to the Power-Cord and Plug Identification Table 1-2.

TABLE 1-1
Power-Cord Color Conductor Identification

| Conductor | Color | Alternate Color |
|------------------------------|--------------|-----------------|
| Ungrounded (Line) | Brown | Black |
| Grounded (Neutral) | Light Blue | White |
| Grounded (Protective Ground) | Green/Yellow | Green/Yellow |

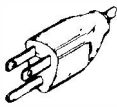
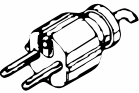
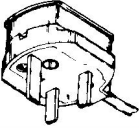
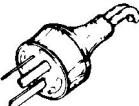
TABLE 1-2
Power-Cord and Plug Identification Information

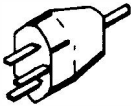
| Plug Configuration | Usage | Nominal Line-Voltage (AC) | Reference Standards | Option # |
|---|----------------------------|---------------------------|---|----------|
|  | North American 120V/15A | 120 V | ¹ ANSI C73.11 ² NEMA 5-15-P ³ IEC 83 | STANDARD |
|  | Universal Euro 220V/16A | 240 V | ⁴ CEE (7), II, IV, VII ³ IEC 83 | A1 |
|  | UK 240V/13A | 240 V | ⁵ BS 1363 ³ IEC 83 | A2 |
|  | Australian 240V/10A | 240 V | ⁶ AS C112 | A3 |
|  | North American 240V/15A | 240 V | ¹ ANSI C73.20 ² NEMA 6-15-P ³ IEC 83 | A4 |
|  | Switzerland 220V/10A | 220 V | ⁷ SEV | A5 |

¹ANSI—American National Standards Institute

²NEMA—National Electrical Manufacturer's Association

³IEC—International Electrotechnical Commission

⁴CEE—International Commission on Rules for the Approval of Electrical Equipment

⁵BS—British Standards Institution

⁶AS—Standards Association of Australia

⁷SEV—Schweizerischer Elektrotechnischer Verein

WARNING

This instrument operates from a single-phase power source, and has a detachable three-wire power cord with a two-pole, three-terminal grounding-type plug. The voltage to ground (earth) from either pole of the power source must not exceed the maximum rated operating voltage, 250 volts.

Before making connection to the power source, determine that the instrument is adjusted to match the voltage of the power source, and has a suitable plug (two-pole, three-terminal, grounding type).

This instrument is safety class 1 equipment (IEC designation). All accessible conductive parts are directly connected through the grounding conductor of the power cord to the grounding contact of the power plug. Therefore, the power plug must only be inserted in a mating receptacle with a grounding contact. Do not defeat the grounding connection. Any interruption of the grounding connection can create an electric shock hazard.*

For electric shock protection, the grounding connection must be made before making connection to the instrument input or output terminals.

*International Electrotechnical Commission.

OPERATING TEMPERATURE

The 7904A can be operated where the ambient air temperature is between 0° and +50° C and can be stored in ambient temperatures from -55° to +75° C. After storage at temperatures outside the operating limits, allow the chassis temperature to reach a safe operating limit before applying power.

The 7904A is cooled by air drawn in through holes in the top, side, and bottom panels and blown out through the fan exhaust. To ensure proper cooling of the instrument, maintain the clearance provided by the feet on the bottom and allow at least 2 inches clearance (more if possible) at the top, sides, and rear of the instrument.

OPERATING POSITION

A bail-type stand, mounted on the bottom of the instrument, permits the instrument to be tilted up about 10° for more convenient crt viewing.

PACKAGING FOR SHIPMENT

If this instrument is to be shipped for long distances by commercial transportation, it is recommended that the instrument be packaged in the original manner. The carton and packaging material in which your instrument was shipped should be saved and used for this purpose.

Also, if this instrument is to be shipped to a Tektronix Service Center for service or repair, attach a tag to the instrument showing the following: Owner of the instrument (with address), the name of a person at your firm who can be contacted, complete instrument type and serial number, and a description of the service required.

If the original packaging is unfit for use or not available, package the instrument as follows:

1. Obtain a corrugated cardboard shipping carton with a 375 pound test strength and having inside dimensions at least six inches greater than the instrument dimensions.
2. Surround the instrument with antistatic polyethylene sheeting or equivalent to protect the finish of the instrument.
3. Cushion the instrument on all sides by tightly packing dunnage or urethane foam between the carton and the instrument, allowing three inches on each side.
4. Seal the carton with shipping tape or with an industrial stapler.
5. Mark the address of the Tektronix Service Center and your return address on the carton in one or more prominent locations.

SPECIFICATION

The electrical characteristics listed in Table 1-3 apply when the following conditions are met: (1) Adjustment of the instrument must have taken place at an ambient temperature between +20° and +30° C, (2) the instrument must be allowed a 20-minute warm-up period, (3) all specifications are valid at an ambient temperature of 0° to +50° C, unless otherwise stated, (4) the instrument must be in an environment that meets the limits described in Table 1-4.

Any applicable conditions not listed above are expressly stated as part of that characteristic. Environmental characteristics are listed in Table 1-4 and Physical characteristics are listed in Table 1-5.

**TABLE 1-3
Electrical Characteristics**

| Characteristics | Performance Requirements |
|--|---|
| VERTICAL SYSTEM | |
| Deflection Factor | Compatible with all 7000-Series plug-in units. (See Table 1-7.) |
| Difference Between Vertical Compartments | 1% or less. |
| Low-Frequency Linearity | 0.1 div or less compression or expansion of a center-screen 2 div. signal positioned anywhere vertically within the graticule area. |
| Frequency Response | Varies with plug-in unit selected. See 7904A Oscilloscope Vertical System Specification, Table 1-7. |
| With 7A29 Amplifier Unit | 3 dB down at 500 MHz. |
| Step Response Rise time (10 to 90%) with 7A29 Amplifier Unit | 700 ps or less. |
| Isolation Between Vertical Compartments (8 Div Signal) LEFT, RIGHT, ALT Modes | At least 160:1 from dc to 100 MHz and at least 80:1 from 100 MHz to 500 MHz. |
| Delay Line | Permits viewing the leading edge of triggering signal. |
| Difference in Signal Delay Between Vertical Compartments | 100 ps or less. |
| Vertical Display Modes | Selected by front-panel VERTICAL MODE Switch. |
| LEFT | Left Vertical unit displayed. |
| ALT | Display alternates between Left and Right Vertical units at rate determined by Horizontal plug-in unit(s). |
| ADD | Display is algebraic sum of Left and Right Vertical units. |
| CHOP | Display chops between Left and Right Vertical units asynchronously to Horizontal plug-in unit(s). |
| RIGHT | Right Vertical unit displayed. |

**TABLE 1-3 (CONT)
Electrical Characteristics**

| Characteristics | Performance Requirements | | | | | | | | |
|--|---|-----------|----------------|------|------|------------------|------------------|--|-----------------|
| VERTICAL SYSTEM (CONT) | | | | | | | | | |
| Vertical Display Modes (cont) SLAVED ALT | <p>Slaved Alt operation occurs if: (1) VERT MODE switch is set to ALT, (2) HORIZ MODE switch is set to ALT or CHOP, (3) Time-base unit is installed in each Horizontal compartment, and (4) Time-base unit installed in A HORIZ compartment operates in slaved mode.</p> <p>When in slaved alt operation the display alternates between: (1) the trace produced by the LEFT VERT unit displayed at the sweep rate of B time-base unit and (2) the trace produced by the RIGHT VERT unit displayed at the sweep rate of the A time-base unit.</p> <p style="text-align: center;">NOTE</p> <p style="text-align: center;"><i>The VERT TRACE SEP (B) control is inoperative in slaved alternate mode</i></p> | | | | | | | | |
| VERTICAL TRACE SEPARATION (B) | Positions "B" trace at least 4 div. above and below "A" trace, when 7904A operates in ALT or CHOP horizontal modes. See note above concerning slaved alternate VERT MODE. | | | | | | | | |
| TRIGGERING | | | | | | | | | |
| A and B TRIGGER SOURCE | Selected by front-panel switches. Lights behind the pushbuttons are illuminated to indicate the trigger source. | | | | | | | | |
| VERT MODE | <p>The trigger source is controlled by the Vert Display Mode selection. The source is shown by the illumination of the LEFT and RIGHT trigger source buttons. The source follows (is same as) the Vert Display with the following two exceptions:</p> <table border="1" style="width: 100%; border-collapse: collapse;"> <thead> <tr> <th style="text-align: center;">VERT MODE</th> <th style="text-align: center;">TRIGGER SOURCE</th> </tr> </thead> <tbody> <tr> <td style="text-align: center;">CHOP</td> <td style="text-align: center;">LEFT</td> </tr> <tr> <td style="text-align: center;">SLAVED ALTERNATE</td> <td style="text-align: center;">RIGHT for A TRIG</td> </tr> <tr> <td></td> <td style="text-align: center;">LEFT for B TRIG</td> </tr> </tbody> </table> <p>See Vertical Display Modes, under VERTICAL SYSTEM in this table, for slaved alternate operation.</p> | VERT MODE | TRIGGER SOURCE | CHOP | LEFT | SLAVED ALTERNATE | RIGHT for A TRIG | | LEFT for B TRIG |
| VERT MODE | TRIGGER SOURCE | | | | | | | | |
| CHOP | LEFT | | | | | | | | |
| SLAVED ALTERNATE | RIGHT for A TRIG | | | | | | | | |
| | LEFT for B TRIG | | | | | | | | |
| LEFT | Trigger source: LEFT vertical unit. LEFT trigger source button illuminated. | | | | | | | | |
| RIGHT | Trigger source: RIGHT vertical unit. RIGHT trigger source button illuminated. | | | | | | | | |
| HORIZONTAL SYSTEM | | | | | | | | | |
| Deflection Factor | Compatible with all 7000-Series plug-in units. (See Plug-In Incompatibilities in Table 1-6.) | | | | | | | | |
| Gain Differences Between Horizontal Compartments | 1% or less. | | | | | | | | |
| DC Linearity | 0.05 division or less error at each graticule line after adjusting for no error at the second and tenth graticule lines. | | | | | | | | |
| Fastest Calibrated Sweep Rate | 500 ps/division. | | | | | | | | |
| Horizontal Display Modes | <p>A: A horizontal unit only. ALT: Dual-sweep, alternates between horizontal units. CHOP: Dual-sweep, chops between horizontal units. B: B horizontal unit only.</p> | | | | | | | | |

TABLE 1-3 (CONT)
Electrical Characteristics

| Characteristics | Performance Requirements |
|---|---|
| HORIZONTAL SYSTEM (CONT) | |
| Phase Shift Between Vertical and Horizontal Systems | 2° or less from dc to at least 35 kHz. |
| With Option 2 | 2° or less from dc to 1 MHz. |
| CALIBRATOR | |
| Wave Shape | Square wave. |
| Polarity | Positive-going with base line at 0 Volt. |
| Output Voltage | (Selected by front-panel CALIBRATOR switch.) |
| Into $\geq 100\ \Omega$ | 40 mV, 0.4 V, 4 V. |
| Into $50\ \Omega$ | 4 mV, 40 mV, 0.4 V. |
| Output Current | 40 mA available through CALIBRATOR output with optional bnc-to-current-loop adapter. CALIBRATOR switch must be set to 4 V for calibrated output. |
| Amplitude Accuracy (P-P Voltage) | Within 1%. |
| Repetition Rate | 1 kHz within 0.25%. |
| Duty Cycle | 49.8% to 50.2%. |
| Rise Time and Fall Time | 500 ns or less into 100 pF or less. |
| SIGNAL OUTPUTS | |
| + SAWTOOTH | |
| Source | Selected by front-panel switch. A: A HORIZ time-base unit. B: B HORIZ time-base unit. |
| Polarity | Positive-going with baseline at 0 V, within 1 V into 1 M Ω . |
| Output Voltage | |
| Rate of Rise | |
| Into $50\ \Omega$ | 50 mV/unit of time selected by time-base unit time/div switch, within 15%. 100 ns/div maximum sweep rate. |
| Into 1 M Ω | 1 V /unit of time selected by time-base unit time/div switch, within 10%. 1 μ s/div maximum sweep rate. |
| + GATE | |
| Source | Selected by front-panel switch. A: A Gate, derived from A HORIZ time-base unit main gate. B: B Gate, derived from B HORIZ time-base unit main gate. |
| Polarity | Positive-going with baseline at 0 V, within 1.0 V into 1 M Ω . |
| Output Voltage | |
| Into $50\ \Omega$ | 0.5 V within 10%. |
| Into 1 M Ω | 10 V within 10% (up to 1 μ s/div sweep rate). |

TABLE 1-3 (CONT)
Electrical Characteristics

| Characteristics | Performance Requirements |
|---------------------------------------|---|
| SIGNAL OUTPUTS (CONT) | |
| + GATE (cont) | |
| Rise Time into 50Ω | 5 ns or less. |
| Fall Time into 50Ω | 15 ns or less. |
| SIG OUT | Selected by B TRIGGER SOURCE switch. |
| Source | Same as B TRIGGER SOURCE. |
| Output Voltage | |
| Into 50 Ω | 25 mV/div of vertical deflection within 25%. |
| Into 1 MΩ | 0.5V/div of vertical deflection, within 25% (maximum output: ± 2 V). |
| Bandwidth into 50Ω | Varies with vertical plug-in selected. See 7904A Oscilloscope Vertical System Specification in Table 1-7. |
| DC Centering | 0 V within 1 V, into 1 MΩ. |
| READOUT DISPLAY | |
| Readout Modes | Internal switch on Readout Board must be in Free-Run position. |
| Free-Run (Not Labeled on Front-Panel) | Continuously displayed (READOUT control not in PULSED position). |
| PULSED | Single-shot operation. |
| Pulsed Source | Selected by front-panel switches. + GATE : Triggered by the trailing edge of the + GATE selected by the front-panel switch. EXT : Controlled through rear-panel remote control connector. MAN : Manual trigger, independent of other pulse sources. |
| DISPLAY | |
| Graticule | |
| Type | Internal, illuminated with variable edge lighting. |
| Area | |
| Standard Instrument and Option 78 | Eight divisions vertical by ten divisions horizontal. Each division equals one centimeter. |
| Option 4, Option 13 | Eight divisions vertical by ten divisions horizontal. Each division equals 0.5 centimeter. |
| Phosphor | |
| Standard, Option 4 | P31. |
| Option 78, Option 13 | P11. |
| Beamfinder | Limits display within graticule area when actuated. |
| Geometry | Within 0.1 division; checked over entire 8 × 10 division graticule area. |

TABLE 1-3 (CONT)
Electrical Characteristics

| Characteristics | Performance Requirements | |
|--|--|----------------------|
| DISPLAY (CONT) | | |
| CRT Characteristics | TEST CONDITIONS: TEKTRONIX C-51 camera with lens set at f/1.2; 1:0.5 Object-to-Image Ratio. Polaroid 20,000 ASA film. | |
| Minimum Photographic Writing Speed (with-out film fogging) | Phosphor | Writing Speed |
| Standard crt | P31 | Approx. 1.25 cm/ns |
| Option 4 | P31 | Approx. 2 cm/ns |
| Option 13 | P11 | 4 cm/ns |
| Option 78 | P11 | 2.5 cm/ns |
| Exposure Defects | With Intensity and Graticule Illumination controls fully counterclockwise, open the camera shutter for 5 minutes. Resulting print must be completely black. | |
| REMOTE CONNECTORS AND SWITCHES | | |
| CONTROL ILLUMINATION | High, medium, and off. Three-position switch located on rear panel of power supply. | |
| CAMERA POWER | Three contact connector compatible with Tektronix C-50 series cameras. | |
| Bottom Pin | Ground. | |
| Center Pin | Single sweep reset. | |
| Top Pin | +15 V. | |
| SINGLE SWEEP RESET | Bnc input connector on rear panel to reset single-sweep function of time-base units installed in A and B HORIZ compartments. | |
| Signal Required | Closure to ground or switching from the high level (+50 to +10 V; sink less than 40 μ A) to the low level (+0.5 V to -5 V; sink less than 12 mA), in less than 1 ms, resets the sweep. Compatible to 15 V open collector TTL source. | |
| A SINGLE SWEEP READY | Bnc connector on rear panel. Remote ready indicator for A HORIZ time-base unit. | |
| Output Signal | Open when not ready. +5 V at 47 Ω source impedance when ready. Output will light a No. 49 bulb. | |
| B SINGLE SWEEP READY | Bnc connector on rear panel. Remote ready indicator for B HORIZ time-base unit. | |
| Output Signal | Open when not ready. +5 V at 47 Ω source impedance when ready. Output will light a No. 49 bulb. | |
| GRATICULE/READOUT SINGLE SHOT | Bnc connector on rear panel. Switching to the low level (+1 V to -5 V; sink less than 2 mA) from the high level (+10 V to +15 V; sink less than 0.3 mA), in less than 1 μ s, triggers the Readout to display one complete readout frame and illuminates the graticule for approximately 0.5 s. Compatible to 15 V open collector TTL source. | |
| Probe Power | Two probe power connectors on rear panel. | |
| Pin 1 | +5 V dc. | |
| Pin 2 | Chassis ground. | |
| Pin 3 | -15 V dc. | |
| Pin 4 | +15 V dc. | |

TABLE 1-3 (CONT)
Electrical Characteristics

| Characteristics | Performance Requirements |
|--|--|
| REMOTE CONNECTORS AND SWITCHES (CONT) | |
| Z-AXIS INPUT (External) | Bnc connector on rear panel. |
| Polarity and Sensitivity | Positive 2 V provides complete blanking from maximum intensity condition. Negative 2 V provides complete unblanking from minimum intensity condition. |
| Low Frequency Limit | Dc. |
| Input Resistance | Approximately 470 Ω . |
| Input Capacitance | Less than 50 pF. |
| Open Circuit Voltage | Approximately 0 V. |
| Maximum Input Voltage | 15 V (dc plus peak ac). |
| Maximum Repetition Rate | 1 MHz. |
| LINE VOLTAGE SELECTOR | Selects 115 V or 230 V range. |
| POWER SOURCE | |
| VOLTAGE RANGE (AC, RMS) | Selected by rear-panel LINE VOLTAGE SELECTOR switch. |
| 115 V Rated | From 90 V to 132 V. |
| 230 V Rated | From 180 V to 250 V. |
| Line Frequency | From 48 Hz to 440 Hz. |
| Power Consumption | 210 W, nominal. |
| Maximum Current | 3.5 A at 60 Hz, 90 V Line. 1.8 A at 60 Hz, 180 V Line. |
| Fuse | 4 A Fast Blow. |

TABLE 1-4
Environmental Characteristics

| Characteristics | Information |
|-----------------|-----------------------|
| Temperature | |
| Operating | 0°C to +50°C. |
| Storage | -55°C to +75°C. |
| Altitude | |
| Operating | 15,000 ft. (4,550m). |
| Storage | 50,000 ft. (15,200m). |

**TABLE 1-4 (CONT)
Environmental Characteristics**

| Characteristics | Information |
|--|--|
| EMC (Electromagnetic Compatibility) | Meets requirements of MIL-STD-461B, when tested in accordance with the following test methods of MIL-STD-462: |
| All instruments | CS-01 and CS-06. Does not meet: CE-01, CE-03, CS-02, RE-02, (T) RE-04, RS-01, and RS-03. |
| Option 3 - Electromagnetic Compatibility | Meets: RE-02 (limited to 1 GHz), RS-01, and RS-03 (limited to 1 GHz). |
| Vibration | Tested to MIL-T-28800C, Sect. 4.5.5.3.1, Type III, Class 5, Style E, except: 0.15 inch p-p amplitude, Sect. 4.5.5.3.1 (c); 55-Hz Resonance Dwell, Sect. 4.5.5.3.1 (e) (2); and 20-to-55 Hz Frequency Increment, Sect. 4.5.5.3.1 (e) (2). |
| Shock | Tested to MIL-T-28800C, Sect. 4.5.5.4.1, Type III, Class 5, Style E. |
| Bench Handling | Tested to MIL-T-28800C, Sect. 4.5.5.4.3, Type III, Class 5, Style E. |
| Transportation | Qualified under National Safe Transit Committee Test Procedure A1, Category II. |
| Bounce | NSTA, Project 1A-B-1. |
| Drop (Packaged Product) | NSTA, Project 1A-B-2. Drop height 24 inches, 16 drops. |
| Humidity | Tested to MIL-STD-810C, Method 507-1, Procedure IV, modified as specified in MIL-T-28800C, paragraph 4.5.5.1.1.2, except: 90 - 95% Relative Humidity (Steps 5 and 6); Operating tests at 50° C (Step 5, second cycle). |
| Electrostatic Discharge | |
| Operating | 0 to 15 kV with no performance degradation. |
| Nonoperating | 0 to 20 kV with no instrument damage. |

**TABLE 1-5
Physical Characteristics**

| Characteristics | Information |
|---|--|
| Ventilation | Safe operating temperature maintained by electronically driven dc fan. |
| Finish | Anodized front panels. Blue-Vinyl paint on aluminum cabinet. |
| Overall Dimensions (Measured at Maximum Points) | See Figure 1-1. |
| Height | 13.6 inches (345 mm). |
| Width | 12.0 inches (305 mm). |
| Length | 22.7 inches (577 mm). |
| Net Weight (Instrument without Plug-Ins) | 37.2 lb (16.9 kg). |

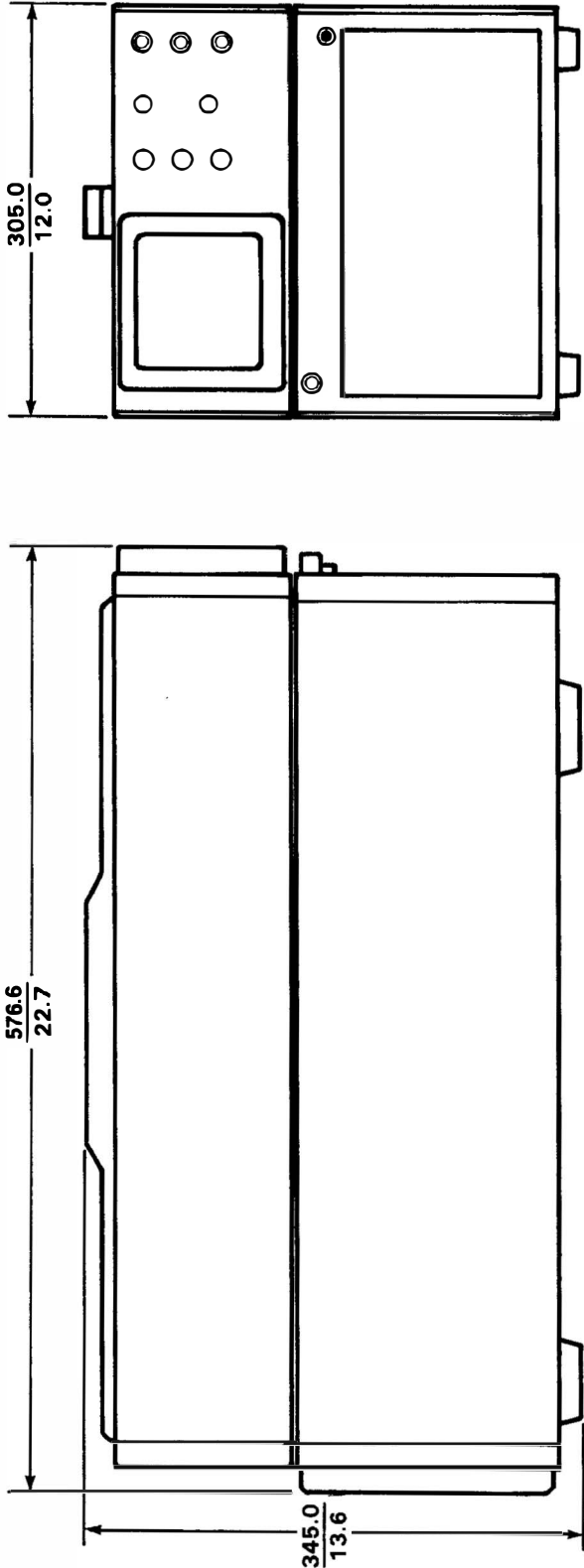

NOTE: DIMENSIONS ARE GIVEN WITH TOP FIGURE IN MILLIMETERS AND THE BOTTOM FIGURE IN INCHES.

Figure 1-1. 7904A Dimensional Drawing.

SYSTEM ELECTRICAL SPECIFICATION

Your Tektronix 7904A Oscilloscope system provides exceptional flexibility in operation with a wide choice of general- and special-purpose plug-in units. The type number of a particular plug-in unit identifies its usage as follows:

The first digit (7) denotes the oscilloscope system for which the plug-in is designed (7000-series).

The second letter describes the purpose of the plug-in unit:

- A—Amplifier unit
- B—"Real time" time-base unit
- C—Curve tracer
- D—Digital unit
- L—Spectrum analyzer
- M—Miscellaneous
- S—Sampling unit
- T—Sampling time-base unit

The third and fourth digits of the plug-in type number do not carry any special connotation.

A "N" suffix letter added to the normal four-digit type number identifies a unit not equipped with the circuitry necessary to encode data for the 7000-series readout system.

Table 1-6 lists any incompatibilities with the variety of plug-in units available for use with the 7904A Oscilloscope.

Table 1-7 lists the vertical specifications which are system dependent. For more complete specifications on plug-in units for the 7000-series oscilloscope system, refer to the Tektronix Products catalog.

Table 1-8 lists the horizontal specifications which are system dependent. For more complete specifications on plug-in units for the 7000-series oscilloscope system, refer to the Tektronix Products catalog.

Table 1-9 lists some special purpose plug-in units available for use with the 7904A Oscilloscope.

**TABLE 1-6
Plug-In Incompatibilities**

The 7904A Oscilloscope is compatible with Tektronix 7000-series Plug-In units with the exceptions listed in the following table:

| Plug-In Unit | Operating Conditions | Symptoms | Cause |
|--|---|---|---|
| 7A2IN | All | No Display | No vertical signal connection. |
| 7B50 7B51 7B52 7B53A 7B53AN 7B53N | All | Leading edge of triggering waveform cannot be viewed. | 7904A delay line length. |
| 7B50 7B51 7B70 7B71 | 7904A Horizontal Mode alternates when both horizontal time-base units are set for single-sweep operation. | Only one time-base unit will reset. | 7904A alternate sweep switching logic locks out one time-base unit; these time-base units do not reset when locked out. |
| 7B85 | 7B85 set for single-sweep operation with Δ time function operational. | Pulsed readout and pulsed graticule from + gate source do not operate normally. | 7B85 sweeps once but needs to sweep twice for generation of holdoff pulse. |
| 7B92A | Time-base unit set for alternate and single-sweep modes. | Pulsed readout and pulsed graticule from + gate source do not operate normally. | Time-base unit sweeps only once when reset, whereas both main and delay sweep are required to generate a holdoff pulse. |
| 7L5 | 7L5 set for single-scan operation. | Pulsed readout and pulsed graticule from + gate source do not operate normally. | 7L5 Sweep Gate remains HI. |
| 7L13 | 7L13 set for single-sweep operation. | 7L13 will not start by remote or camera connection. | 7L13 does not provide single-sweep reset. |

TABLE 1-6 (CONT)
Plug-In Incompatibilities

| Plug-In Unit | Operating Conditions | Symptoms | Cause |
|--------------|-------------------------------------|---|--|
| 7S12 | 7S12 set for single-scan operation. | 7S12 will not start by remote or camera reset connector. | 7S12 does not provide single-sweep reset. |
| | All | 7S12 will not alternate with other sweep plug-ins. | 7S12 does not generate holdoff pulses. |
| | Intensified zone | The intensified zone is too bright and may be the only part of the display visible. | No contrast control. |
| 7S14 | All | 7S14 will not alternate with other sweep plug-ins. | 7S14 does not provide proper holdoff pulses. |

TABLE 1-7
7904A Oscilloscope Vertical System Specification

| Amplifier Plug-In Unit | Probe | Bandwidth (MHz) | Rise Time (ns) | Accuracy ^a | | | Vert Sig Out | |
|------------------------|-----------------|--------------------|-----------------|-------------------------|---------------------------|-------------------------|--------------|---------|
| | | | | Ext Cal 0° to +50°C (%) | Int Cal +15° to +35°C (%) | Int Cal 0° to +50°C (%) | BW (MHz) | Tr (ns) |
| 7A11 | Integral | 250 | 1.4 | 2 | 3 | 4 | 140 | 2.5 |
| 7A12 | None | 120 | 2.9 | 2 | 3 | 4 | 110 | 3.2 |
| | P6053B | | | 3 | 4 | 5 | | |
| 7A13 | None | 105 | 3.5 | 1.5 | 2.5 | 3.5 | 100 | 3.5 |
| | P6053B | | | | | | 100 | 3.5 |
| | P6055 | | | | | | 65 | 5.4 |
| 7A14 | P6021 | 55 | 6.4 | 2 | 3 | 4 | 50 | 7.0 |
| | P6022 | 120 | 2.9 | | | | 100 | 3.5 |
| 7A15A | None | 80 | 4.4 | 2 | 3 | 4 | 70 | 5.0 |
| | P6053A | | | 3 | 4 | 5 | | |
| 7A16A | None | 225 | 1.6 | 2 | 3 | 4 | 140 | 2.5 |
| | P6053B | | | 3 | 4 | 5 | | |
| 7A17 | None | 150 | 2.4 | | | | 15 | 24 |
| 7A18A | None | 75 | 4.7 | 2 ^b | 3 ^b | 4 ^b | 70 | 5.0 |
| | P6053B | | | 3 ^b | 4 ^b | 5 ^b | | |
| 7A19 | None | 500 | 0.8 | 3 | | 4 | 300 | 1.2 |
| | P6056 P6057 | | | 4 | | 5 | | |
| 7A19 (10 mV/Div Only) | None | 500 | 0.8 | 2 | 3 | 4 | 300 | 1.2 |
| | P6056, P6057 | | | 3 | 4 | 5 | | |
| | P6201 | | | 4 | | 5 | | |
| 7A22 | None or Any | 1 MHz (within 10%) | 350 (within 9%) | 2 | 3 | 4 | 1.0 ±10% | 350 ±9% |
| 7A24 | None | 350 | 1.0 | 2 | 3 | 4 | 140 | 2.5 |
| | P6056, P6057 | | | 3 | 4 | 5 | | |
| | P6201 | | | 3 | 4 | 5 | | |
| 7A26 | None | 200 | 1.8 | 2 | | 3 | 140 | 2.5 |
| | P6053B | | | 3 | | 4 | | |
| 7A29 | None | 500 | 0.8 | 2 | 3 | 4 | 500 | 0.9 |
| | P6056 | | | 3 | 4 | 5 | | |

^aDeflection Factor accuracy is checked as follows:
 EXT CAL 0°C to +50°C—Plug-in gain set at a temperature within 10°C of operating temperature, using an external calibrator whose accuracy is within 0.25%.
 INT CAL +15°C to +35°C—Plug-in gain set while operating within a temperature range of +15°C to +35°C using the oscilloscope accuracy.
 INT CAL 0°C to +50°C—Plug-in gain set using the oscilloscope calibrator (within 10°C of the operating temperature) in a temperature range between 0°C and +50°C.

^b7A18A Opt. 6 (offset) version. Add 1% to accuracy figures when switched to "OFFSET".

TABLE 1-8
7904A Oscilloscope Horizontal System Specification

| Time-Base Unit | Performance Feature | Maximum Calibrated Sweep Rate | Triggered Frequency Range |
|----------------|--|-------------------------------|---------------------------|
| 7B50A | Delayed Sweep | 5 ns/div | Dc to 150 MHz |
| 7B70 | Delayed Sweep and Ext Amplifier | 2 ns/div | Dc to 200 MHz |
| 7B71 | Dual-Sweep Delaying and Displayed | 2 ns/div | Dc to 200 MHz |
| 7B92A | Display Switching | 0.5 ns/div | Dc to 500 MHz |
| 7B80 | Delayed Sweep | 1 ns/div | Dc to 400 MHz |
| 7B85 | Delaying Sweep | 1 ns/div | Dc to 400 MHz |
| 7B87 | Time Base (with Pre-Trigger Acquire Clock for 7854 only) | 1 ns/div | Dc to 400 MHz |
| 7B10 | Delayed Sweep | 0.5 ns/div | Dc to 700 MHz |
| 7B15 | Δ Delaying Sweep | 0.5 ns/div | Dc to 700 MHz |

TABLE 1-9
Special Purpose Plug-In Units

| Plug-In Unit | Performance Feature |
|--------------|--|
| 7CT1N | Low-Power Semiconductor Curve Tracer |
| 7D01/7D01F | Logic Analyzer |
| 7D02/7002F | Logic Analyzer |
| 7D11 | Digital Delay |
| 7D12 | A/D Converter, plug-in modules provide flexible measurement capability |
| 7D13A | Measures Temperature, Voltage, Current and Resistance |
| 7D15 | Universal Counter/Timer |
| 7D20 | Programmable Digitizer |
| 7K11 | CATV Preamplifier |
| 7L5 | 20 Hz to 5 MHz Spectrum Analyzer |

TABLE 1-9 (CONT)
Special Purpose Plug-In Units

| Plug-In Unit | Performance Feature |
|--------------|--|
| 7L12 | 100 kHz to 1.7 GHz Spectrum Analyzer |
| 7L14 | 10 kHz to 1.8 GHz Spectrum Analyzer |
| 7L18 | 1.5 GHz to 60 GHz Spectrum Analyzer |
| 7M11 | Dual 50Ω Delay Line |
| 7M13 | Readout Access Unit |
| 7S11 | Accepts Plug-In Sampling Heads |
| 7S12 | Time Domain Reflectometer and Sampling Applications |
| 7S14 | Dual Trace Delay Sweep Sampler |
| 7T11 | Random or Sequential; equivalent or Real-Time Sampling |

STANDARD ACCESSORIES

The following accessories are furnished with your 7904A Oscilloscope. For more detailed information refer to the tabbed Accessories page at the rear of this manual.

- 1 ea Instruction Manual
- 1 ea Blue Faceplate Filter (installed)
- 1 ea Power Cord

OPTIONAL ACCESSORIES (not included)

The following accessory is available for use with your 7904A Oscilloscope. For more detailed information refer to the tabbed Accessories page at the rear of this manual. Order Optional Accessories through your local Tektronix Field Office or representative.

- 1 ea Current Loop Probe Adapter

OPERATING INSTRUCTIONS

To operate the 7904A effectively, the user must become familiar with the operation and capabilities of the instrument. Familiarization begins with installation instructions followed by a brief description of all controls connectors and indicators. Next, an Operators Checkout Procedure checks basic instrument operation and provides procedural familiarization. Detailed Operating Instructions and Applications convey the more complex details of 7904A operation.

For detailed information for specific plug-in units used with the 7904A, refer to the manuals for that unit.

WARNING

To avoid electric shock hazard, see Installation in the General Information section of this manual before operating this instrument.

PLUG-IN UNITS

The 7904A accepts up to four Tektronix 7000-series plug-in units, allowing selection of bandwidth, sensitivity, display mode, etc., and provides for future expansion of the system. Refer to Tables 1-7 through 1-9 in the General Information section.

The overall capabilities of the system are mainly determined by the characteristics of the selected plug-ins. Some typical combinations are given under Applications in this section, along with simplified set up instructions. For information on other plug-in units, refer to the current Tektronix Products catalog.

INSTALLATION OF PLUG-IN UNITS

CAUTION

To prevent instrument damage, plug-in units should not be installed or removed without first turning the instrument power off.

To install a plug-in unit into a compartment, align the slots in the top and bottom of the plug-in unit with the associated guide rails within the plug-in compartment. Insert the plug-in unit into the compartment until it locks into place. To remove a plug-in unit, pull out on the release latch. To meet the EMC (electromagnetic compatibility) specifications, cover all unused plug-in compartments with an EMC shielded blank plug-in panel, Tektronix Part 016-0155-00.

The gain of the 7904A vertical and horizontal systems have been normalized to allow plug-in units to be interchanged among plug-in compartments without adjustment of the system. The basic performance of the plug-in units should be checked when installed, to verify their accuracy (refer to the operating instructions in the plug-in unit manual).

CONTROLS AND CONNECTORS

The 7904A front and rear panels are shown in Figure 2-1 and Figure 2-2. A brief, functional description of each control and connector is included in the illustration. Refer to Detailed Operating Information for additional information.

FRONT-PANEL COLOR CODING

The 7904A front panel is color coded to define areas by function. Blue identifies the display mode controls; green identifies triggering controls.

The gray tint blocks have no functional assignment, but indicate the relationship among controls and/or connectors.

OPERATORS CHECKOUT PROCEDURE

The Operators Checkout Procedure may be used to verify proper operation of the front-panel controls and for familiarization with the instrument. Only instrument functions (not measurement quantities or specifications) are checked in the procedure; therefore, a minimum amount of test equipment is required. If performing the Operators Checkout Procedure reveals improper performance or instrument malfunction, check the operation of associated equipment; then refer to qualified service personnel for repair or adjustment of the instrument.

TEST EQUIPMENT REQUIRED

The following test equipment was used in preparing the Operators Checkout Procedure. Other test equipment which meets these requirements may be substituted. When other equipment is substituted, the control settings or setup may need to be altered.

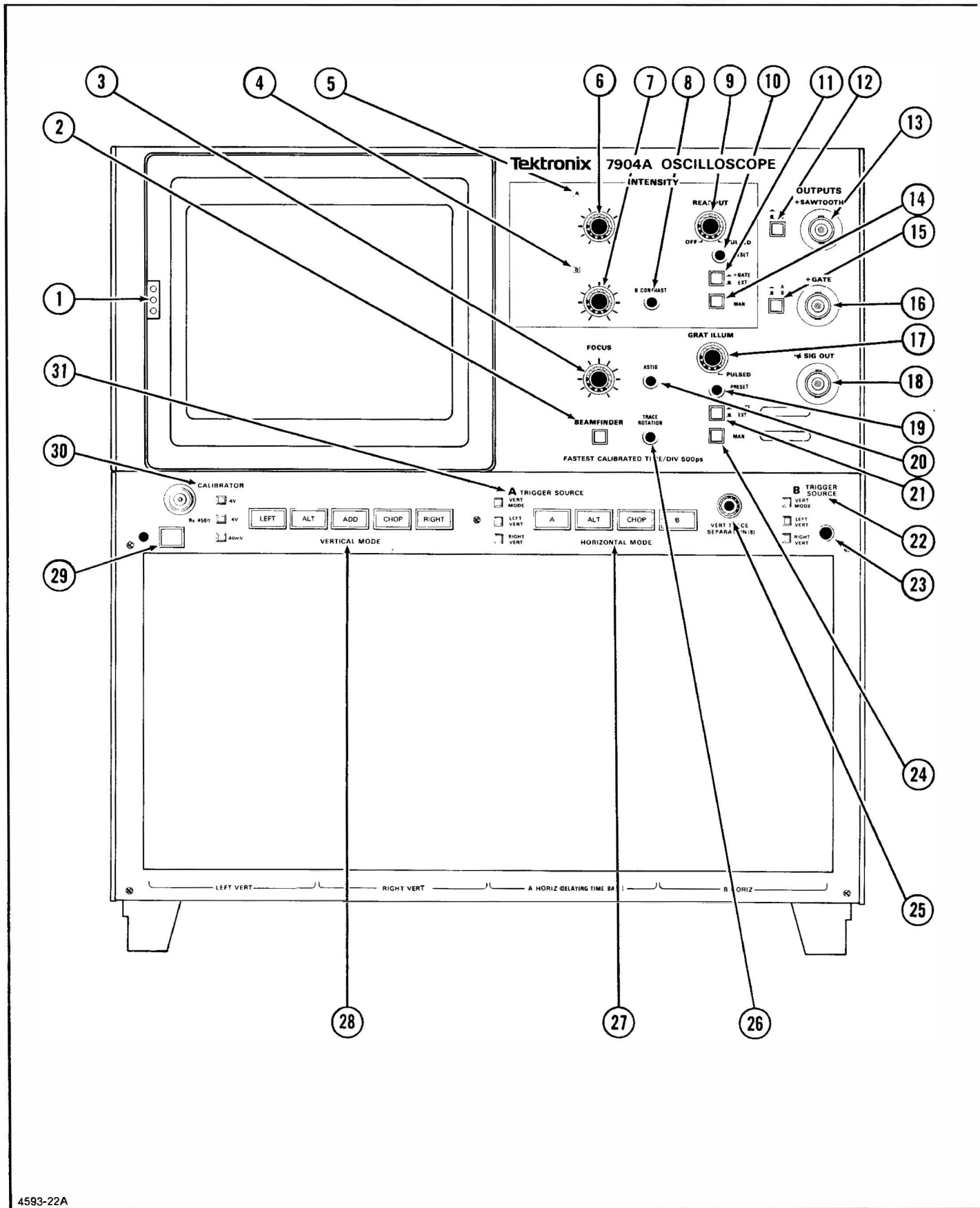
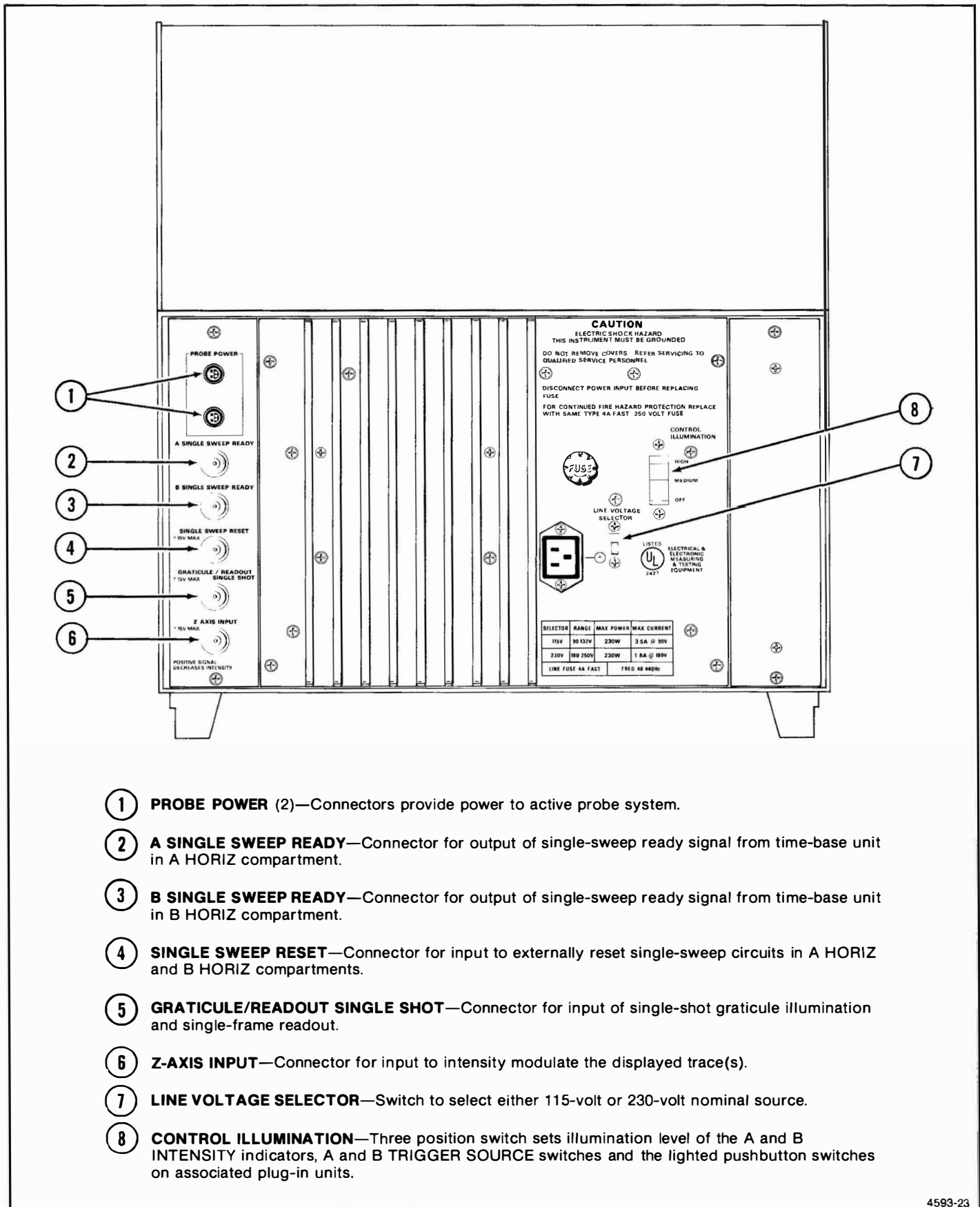

Figure 2-1. Front-panel controls, connectors and Indicators.

- ① **Camera Power Connector (not labeled)**—Three-pin connector provides power for camera operation and receives single sweep-reset signal.
- ② **BEAMFINDER**—Switch when pressed compresses and defocuses display within graticule area.
- ③ **FOCUS**—Control optimizes crt trace definition.
- ④ **B INTENSITY**—Indicator illuminates when selected by the HORIZONTAL MODE switch.
- ⑤ **A INTENSITY**—Indicator illuminates when selected by the HORIZONTAL MODE switch.
- ⑥ **A INTENSITY**—Control to determine brightness of trace produced by the plug-in unit installed in the A HORIZ compartment.
- ⑦ **B INTENSITY**—Control to determine brightness of trace produced by the plug-in unit installed in the B HORIZ compartment.
- ⑧ **B CONTRAST**—Screwdriver adjustment varies brightness of intensified portion of display.
- ⑨ **READOUT INTENSITY**—Control to determine brightness of readout display. Disables Readout System in counterclockwise detent position. Activates PULSED in clockwise detent position.
- ⑩ **READOUT PRESET**—Screwdriver adjustment (PULSED operation only) sets PULSED readout intensity.
- ⑪ **READOUT +GATE OR EXT**—Switch to select either +GATE or EXT actuation of the PULSED readout mode.
- ⑫ **A OR B +SAWTOOTH**—Switch to select A or B time-base unit as source for +SAWTOOTH OUTPUT signal.
- ⑬ **+SAWTOOTH**—Connector to output signal derived from the A or B time-base unit.
- ⑭ **READOUT MAN**—Switch when pressed actuates one frame of readout display.
- ⑮ **A OR B +GATE**—Switch to select either A or B time-base unit as source of +GATE output.
- ⑯ **+GATE**—Connector to output positive-going gate signal from the time-base unit in the A or B horizontal compartment.
- ⑰ **GRAT ILLUM**—Control varies level of graticule illumination or activates PULSED GRAT ILLUM functions.
- ⑱ **SIG OUT**—Connector to output signal derived from vertical signal as selected by B TRIGGER SOURCE switch.
- ⑲ **GRAT ILLUM PRESET**—Screwdriver adjustment to vary level of graticule illumination in GRAT ILLUM PULSED mode.
- ⑳ **ASTIG**—Screwdriver adjustment used in conjunction with FOCUS control to obtain a well defined display.
- ㉑ **GRAT ILLUM +GATE OR EXT**—Switch to select between +GATE or EXT actuation of graticule illumination.
- ㉒ **B TRIGGER SOURCE**—Switches select internal trigger source for B HORIZ plug-in unit.
- ㉓ **Ground (not labeled)**—Binding post to establish common ground between associated equipment.
- ㉔ **GRAT ILLUM MAN**—Switch when pressed actuates one graticule illumination.
- ㉕ **VERT TRACE SEPERATION (B)**—Control vertically positions the B HORIZ trace with respect to the A HORIZ trace (dual-sweep only).
- ㉖ **TRACE ROTATION**—Screwdriver adjustment to align trace(s) with graticule lines.
- ㉗ **HORIZONTAL MODE**—Switches select input source for horizontal deflection.
- ㉘ **VERTICAL MODE**—Switches select source of input for vertical deflection.
- ㉙ **POWER (Switch and indicator)**—Switch controls power to instrument; indicator illuminates when power is on.
- ㉚ **CALIBRATOR**—Switches select 4 V, 0.4 V, and 40 mV calibrated square-wave voltages at 1 kHz repetition rate at connector output.
- ㉛ **A TRIGGER SOURCE**—Switches select internal trigger source for A HORIZ plug-in unit.

Figure 2-1 (cont). Front-panel controls, connectors and indicators.



- 1 **PROBE POWER** (2)—Connectors provide power to active probe system.
- 2 **A SINGLE SWEEP READY**—Connector for output of single-sweep ready signal from time-base unit in A HORIZ compartment.
- 3 **B SINGLE SWEEP READY**—Connector for output of single-sweep ready signal from time-base unit in B HORIZ compartment.
- 4 **SINGLE SWEEP RESET**—Connector for input to externally reset single-sweep circuits in A HORIZ and B HORIZ compartments.
- 5 **GRATICULE/READOUT SINGLE SHOT**—Connector for input of single-shot graticule illumination and single-frame readout.
- 6 **Z-AXIS INPUT**—Connector for input to intensity modulate the displayed trace(s).
- 7 **LINE VOLTAGE SELECTOR**—Switch to select either 115-volt or 230-volt nominal source.
- 8 **CONTROL ILLUMINATION**—Three position switch sets illumination level of the A and B INTENSITY indicators, A and B TRIGGER SOURCE switches and the lighted pushbutton switches on associated plug-in units.

Figure 2-2. Rear-panel controls and connectors.

1. Amplifier Unit (2 Required)

Description: Compatible with 7904A Oscilloscope. One dual-trace unit required to check vertical readout fields.

Type Used: Any of the compatible 7A-series units. Refer to Table 1-7 in the General Information section.

2. Time-Base Unit (2 Required)

Description: Compatible with 7904A Oscilloscope. One Dual Time-Base unit or Delaying Time-Base unit required to check horizontal readout fields.

Type Used: Any compatible 7B-series units. Refer to Table 1-8 in the General Information section.

3. Sine-Wave Generator

Description: Frequency range, 250 kilohertz to 1 megahertz; output amplitude, two volts peak-to-peak into 50 ohms. (The sine-wave generator is used for the Z-AXIS INPUT check only.)

Type Used: TEKTRONIX FG503 Function Generator (requires TM500 power module).

4. Coaxial Cables (2 Required)

Description: Length, 42 inches; connectors, bnc.

Type Used: Type RG-58/U, 50-ohm coaxial, Tektronix part 012-0057-01.

5. T Connector

Description: Connectors, bnc to bnc.

Type Used: bnc to bnc connector, Tektronix Part 103-0030-00.

2. Connect the 7904A to a power source that meets the voltage and frequency requirements of this instrument. Refer to Power Source Information and Table 1-3, Electrical Characteristics in Section 1, General Information.

3. Install Tektronix 7A-series amplifier units in the LEFT VERT and RIGHT VERT compartments. Install Tektronix 7B-series time-base units in the A HORIZ and B HORIZ compartments.

4. Press the POWER switch to the on (locked in) position.

5. Set both time-base units to 1 millisecond/division and triggering to auto mode with ac coupling from the internal source.

6. Rotate the A INTENSITY control until the trace is at a desirable viewing level (near midrange). Position the trace as necessary for an on-screen display.

7. Connect the CALIBRATOR output to the input of the left amplifier unit with a 42-inch coaxial cable.

8. Set the left amplifier unit deflection factor to display a signal amplitude of 2 divisions centered on the screen.

9. Set the A horizontal time-base unit triggering for a stable display.

DISPLAY FOCUS

10. Rotate the FOCUS and ASTIG controls and observe the square-wave display. Notice that the thickness of the trace varies. Set the FOCUS and ASTIG controls for a well-defined trace.

TRACE ALIGNMENT

11. Disconnect the input signal. Using the left amplifier unit Position control, align the trace with the center horizontal graticule line. If necessary use the TRACE ROTATION control to align the trace with the center graticule line.

GRATICULE ILLUMINATION

12. Rotate the GRAT ILLUM control throughout its range and notice that the graticule lines are illuminated as the control is turned clockwise. Notice that in the fully clockwise detent the graticule illumination is in the PULSED MODE. Press the MAN button and notice the graticule is illuminated each time the button is pressed. Refer to Graticule Illumination in the Detailed Operating Information for more information.

PRELIMINARY SETUP

1. Set the front-panel controls as follows:

- A INTENSITY..... counterclockwise
- FOCUS..... midrange
- B INTENSITY..... counterclockwise
- READOUT..... OFF
- GRAT ILLUM..... counterclockwise
- POWER..... OFF
- CALIBRATOR..... 4 V
- VERTICAL MODE..... LEFT
- A TRIGGER SOURCE..... VERT MODE
- HORIZONTAL MODE..... A
- VERT TRACE SEPARATION (B).... midrange
- B TRIGGER SOURCE..... VERT MODE

CONTROL ILLUMINATION

13. Set the rear-panel CONTROL ILLUMINATION switch to HIGH. Notice that the A INTENSITY indicator and the lighted pushbutton switches on the 7904A and plug-in units are all illuminated to a high-intensity level. Sequentially press all of the HORIZONTAL MODE switch positions and notice the A and B INTENSITY indicator lights; these lights indicate which intensity control is active. Set the CONTROL ILLUMINATION switch to the MEDIUM position. Observe that the selected intensity indicator light and the lighted pushbutton switches on the 7904A and plug-in units are dimmed. Set the CONTROL ILLUMINATION switch to OFF and notice that the selected intensity indicator and pushbutton switches are extinguished.
14. Set the rear-panel CONTROL ILLUMINATION switch to the HIGH position. Return the HORIZONTAL MODE switch to A.

VERTICAL DEFLECTION SYSTEM

15. Connect the 4 V CALIBRATOR output to the input connectors of both amplifier units with two 42-inch coaxial cables and a bnc T connector. Set the deflection factor of the left amplifier unit to display about 2 divisions of signal on the crt.
16. Notice that the position control of only the left amplifier unit affects the vertical position of the displayed trace. Position the trace to the upper half of the graticule.
17. Set the VERTICAL MODE switch to RIGHT. Set the deflection factor of the right amplifier unit to display about 2 divisions of signal on the crt.
18. Notice that the position control of only the right amplifier unit affects the vertical position of the displayed trace. Position the trace to the lower half of the graticule.
19. Set the VERTICAL MODE switch to ALT. Two traces should be displayed on the crt. The top trace is produced by the left amplifier unit and the bottom trace is produced by the right amplifier unit; the sweep for both traces is produced by the A time-base unit. Set the sweep rate of the A time-base unit to 50 milliseconds/division; notice the display alternates between the left and right amplifier plug-in units after each sweep. Turn the A time-base sweep rate switch throughout its range; notice that the display alternates between amplifier units at all sweep rates.
20. Set the VERTICAL MODE switch to CHOP. Turn the A time-base unit sweep rate switch throughout its range. A dual-trace display will be presented at all sweep rates, and both amplifier units are displayed

by the A time-base unit on a time-sharing basis. Set the A time-base unit sweep rate switch to 0.5 milliseconds/division.

21. Set the VERTICAL MODE switch to ADD. The display should be four divisions in amplitude. Notice that the position control of either amplifier unit moves the display. Set the VERTICAL MODE switch to LEFT.

HORIZONTAL DEFLECTION SYSTEM

22. Position the start of the trace to the left graticule line with the A time-base unit Position control. Notice that only the A time-base unit Position control affects the horizontal position of the displayed trace (not the Position control of the B time-base unit).
23. Set the HORIZONTAL MODE switch to B.
24. Notice that only the B time-base unit Position control affects the horizontal position of the displayed trace. Position the start of the trace to the left graticule line with the B time-base unit Position control. Set the B time-base unit Triggering controls for a stable display.
25. Set the HORIZONTAL MODE switch to ALT. Two traces should be presented on the crt. If the traces overlap, adjust the VERT TRACE SEPARATION (B) control to position one trace to the bottom of the graticule area. Turn the sweep-rate switches of both time-base units throughout their ranges. Observe that each time-base unit controls one of the traces independently of the other time-base unit. Also notice that when one of the time-base units is set to a slow sweep rate (below about 50 milliseconds/division), sweep alternation is evident (only 1 of the traces is presented on the crt at a time). Set the sweep rates of both time-base units to 0.5 milliseconds/division. Rotate the A INTENSITY control; notice that the intensity of the trace produced by the A time-base unit changes. Likewise, the B INTENSITY control changes the intensity of the trace produced by the B time-base unit only. Return both intensity controls to desirable levels.
26. Set the HORIZONTAL MODE switch to CHOP. Two traces should be displayed on the crt in a manner similar to that of the ALT display. Turn the sweep-rate switches of both time-base units throughout their ranges. A dual-trace display will be presented at all sweep rates.
27. Set the VERTICAL MODE switch to CHOP. Four traces should be displayed on the crt. If not, adjust the position controls of the amplifier units and the VERT TRACE SEPARATION (B) control to position

the four traces into view. Set the position controls of the plug-in units to identify which trace is produced from each plug-in unit (if amplifier units have the identify feature, it can be used to identify the traces). Set the A time-base unit for a sweep rate of 1 millisecond/division. Notice that there are two displays from the left vertical unit; one at the sweep rate of the A time-base unit and the other at the sweep rate of the B time-base unit. Notice also that there are two displays from the right vertical unit; again, one at the sweep rate of the A time-base unit and the other at the sweep rate of the B time-base unit.

28. Set the HORIZONTAL MODE switch to ALT. Observe that the display is very similar to that obtained in the previous sweep. The main difference in this display is that the traces are now displayed alternately (noticeable only at slow sweep rates).
29. Set the VERTICAL MODE switch to ALT. The trace produced by the left amplifier unit should be displayed at the sweep rate of the B time-base unit and the trace produced by the right amplifier unit should be displayed at the A time-base unit sweep rate. This feature is called slaved-alternate operation and is obtained only when the VERTICAL MODE switch is in the ALT position, the HORIZONTAL MODE switch is in either the ALT or the CHOP position, and the time-base units are in the independent mode.

TRIGGERING

30. Set the VERTICAL MODE switch to LEFT and the HORIZONTAL MODE switch to A. Center the display on the crt with the left amplifier unit Position control. Disconnect the input signal from the right amplifier unit input connector. Sequentially select all of the VERTICAL MODE switch positions. Notice that a stable display is obtained for all positions of the VERTICAL MODE switch (a straight line is displayed when in the RIGHT switch position).
31. Set the A TRIGGER SOURCE switch to LEFT VERT. Again, sequentially select all of the VERTICAL MODE switch positions; notice that the display is again stable in all positions, as in the previous step, and that the LEFT VERT pushbutton is illuminated.
32. Set the A TRIGGER SOURCE switch to RIGHT VERT. Sequentially select all of the VERTICAL MODE switch positions and notice that a stable display cannot be obtained in any position (this is because there is no input signal connected to the right vertical unit) and that the RIGHT VERT pushbutton is illuminated. Return the A TRIGGER SOURCE switch to VERT MODE and notice that it is illuminated.

33. The B TRIGGER SOURCE switch operates similar to the A TRIGGER SOURCE switch when the B time-base unit is selected to provide the display. Set the B TRIGGER SOURCE switch to VERT MODE and the VERTICAL MODE switch to ALT.
34. Set the HORIZONTAL MODE switch to ALT or CHOP. Notice that this is the same display obtained in step 29 (slaved-alternate operation).

READOUT

35. Turn the READOUT control clockwise until an alphanumeric display is visible within the top or bottom division of the crt graticule. Change the deflection factor of the amplifier unit that is selected for display. The readout display should change as the deflection factor is changed. Likewise, change the sweep rate of the time-base unit which is selected for display; the readout should change as the sweep rate is changed.
36. Set the time-base unit for X10 magnification. Notice that the readout display will change to indicate the correct magnified sweep rate. If a readout-coded 10X probe is available for use with the amplifier unit, install it on the input connector of the right amplifier plug-in unit. Notice that the deflection factor indicated by the readout is increased by 10 times when probe is added. Return the time-base unit to normal sweep operation and disconnect the probe.
37. Sequentially select all of the VERTICAL MODE and HORIZONTAL MODE switch positions. Notice that the readout from a particular plug-in occupies a specific location on the display area. If either of the vertical plug-in units is a dual-trace unit, the readout for channel 2 is displayed within the lower division of the crt graticule. Return the VERTICAL MODE switch to LEFT and the HORIZONTAL MODE switch to A. Set the READOUT control to OFF.

BEAMFINDER

38. Set the deflection factor of the left amplifier unit to 10 millivolts/division and the calibrator for a 4 V output. Notice that the square-wave display is not visible, since the deflection exceeds the scan area of the crt.
39. Press the BEAMFINDER button; notice that the display is returned to the viewing area in compressed form. Release the BEAMFINDER button and notice that the display again disappears from the viewing area.
40. With the BEAMFINDER pushed in, adjust the Position control of the displayed amplifier unit to position the compressed display near graticule center. Then, increase the amplifier-unit deflection

Operating Instructions—7904A

factor until the display is reduced to about 2 divisions vertically. Release the BEAMFINDER button and observe that the display remains within the viewing area.

CALIBRATOR

41. Select different CALIBRATOR pushbuttons (labeled 4 V, 0.4 V, and 40 mV) and notice that the displayed signal changes accordingly (CALIBRATOR output must be terminated into more than a 100 kilohm load for stated output). When the CALIBRATOR output is terminated into 50 ohms, the output is 0.1 times the stated output. Disconnect the CALIBRATOR signal.

Z-AXIS INPUT

42. If an external signal is available (e.g., sine-wave signal from a function generator), the operation of the Z-AXIS INPUT can be demonstrated.

Connect an approximate 2-volt peak-to-peak, 1-kilohertz sine-wave signal, to the left vertical amplifier unit input with a coaxial cable and bnc T-connector. Set the A HORIZ time-base unit sweep rate to display 5 cycles of sine-wave signal and set the amplifier unit deflection factor to 0.5 volts/division (four division display). Now, connect a coaxial cable from the T-connector, at the amplifier unit input, to the rear-panel Z-AXIS INPUT connector. Rotate the A INTENSITY control until intensity modulation is visible on the display. The positive peaks of the waveform should be blanked out and the negative peaks intensified. Notice that the setting of the intensity controls determines the amount of intensity modulation that is visible. Disconnect all the cables.

DETAILED OPERATING INFORMATION

GRATICULE

The graticule matrix is scribed on the inside of the crt faceplate, providing accurate, parallax-free measurements. The graticule is divided into eight vertical and ten horizontal divisions. Each division is one centimeter square divided into five minor divisions along each axis. Options are available for 0.5 centimeter square divisions (see Instrument Options section). The vertical gain and horizontal timing of the plug-in units are calibrated to the graticule so that accurate measurements can be made from the crt. The illumination of the graticule lines can be varied with the GRAT ILLUM control.

Figure 2-3 shows the graticule and defines the various measurement lines. The terminology defined here will be used in all discussions involving measurements from

the graticule. The markings: 0%, 10, 90, and 100 on the left side of the graticule are for accurate rise-time measurements.

GRATICULE ILLUMINATION

The GRAT ILLUM control varies the illumination of the graticule lines. The GRAT ILLUM can also be operated in the PULSED mode. With the GRAT ILLUM control set to the PULSED (detent) position, and the + GATE/EXT switch set to + GATE (pushbutton in), the graticule will be illuminated momentarily after the + GATE occurs. The + GATE switch selects whether A time-base gate or B time-base gate triggers the graticule illumination. With the GRAT ILLUM + GATE/EXT switch set to EXT the momentary graticule illumination can be actuated by applying a remote signal to the rear-panel GRATICULE/READOUT SINGLE SHOT connector (see Table 1-3, in section 1, for specifications). When operating in the PULSED mode, the level of illumination is controlled by the GRAT ILLUM PRESET screwdriver adjustment.

LIGHT FILTER

The tinted face-plate filter minimizes light reflections from the face of the crt to improve contrast when viewing the display under high-ambient-light conditions. This filter should be removed for waveform photographs or for viewing high-writing-rate displays. To remove the filter, pull outward on the bottom of the plastic crt mask and remove it from the crt bezel. Remove the tinted filter; leave the clear plastic face-protector (implosion shield) installed and replace the mask. The face-plate protector should be left in place at all times to protect the crt face from scratches and the operator from crt implosion.

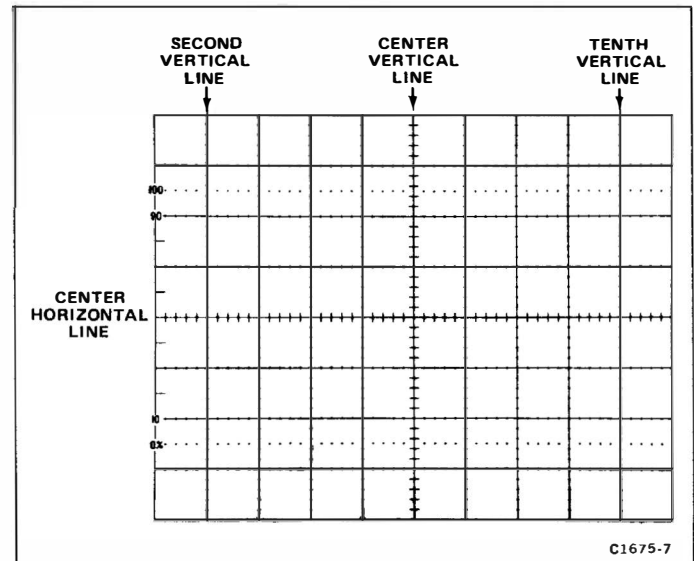

Figure 2-3. Definition of graticule measurement lines.

WARNING

Do not remove the clear plastic implosion shield covering the crt face plate; the implosion shield provides protection to the operator from crt implosion.

An optional mesh filter is available from Tektronix (included with Option 3). This filter provides shielding against radiated electromagnetic interference from the face of the crt. It also serves as a light filter to make the trace more visible under high-ambient light conditions. The mesh filter fits in place of the plastic tinted filter. Order the filter by Tektronix Part 378-0603-00.

CONTROL ILLUMINATION

The CONTROL ILLUMINATION switch, located on the rear panel, sets the illumination level of the A and B INTENSITY indicators, the A and B TRIGGER SOURCE switches, and of the lighted pushbutton switches on the plug-in units. The positions available are OFF, MEDIUM, and HIGH. The CONTROL ILLUMINATION switch does not affect the function-indicator lights (such as the triggered or single-sweep-ready lights).

INTENSITY CONTROLS

The A INTENSITY control determines the brightness of the display produced by the plug-in unit installed in the A HORIZ compartment. The B INTENSITY control determines the brightness of the display produced by the plug-in unit installed in the B HORIZ compartment. The READOUT intensity control affects the brightness of only the readout portion of the crt display.

To protect the crt phosphor, this instrument contains protection circuitry which limits the display intensity by limiting the crt beam current to a safe level. If the intensity control(s) is advanced to a point where the crt beam current exceeds a potentially damaging level for more than about ten milliseconds, the circuit action automatically limits the beam current to a safe level. The crt beam current is limited to an even lower level when operating in an X-Y mode, or if either one of the time-base units is set to a slow sweep rate (even if the time-base unit with slow sweep rate is not selected for display by the HORIZONTAL MODE switch). This reduces the danger of damaging the crt phosphor with a stationary or slowly moving spot. Since beam-current limiting does not take effect for about ten milliseconds, the full display-intensity capability of this instrument is available for most single-shot and photographic uses.

DISPLAY FOCUS

This instrument contains an automatic-focusing circuit which maintains optimum focus for all intensity settings after a correct setting of the FOCUS control is

established. The easiest way to obtain the correct setting of the FOCUS control is to set the READOUT INTENSITY control so that the readout portion of the display is clearly visible. Adjust the FOCUS control for the best definition of the readout display.

ASTIGMATISM-FOCUS ADJUSTMENTS

If a well-defined display cannot be obtained with the FOCUS control, adjust the ASTIG adjustment as follows:

NOTE

To check for proper setting of the ASTIG adjustment, slowly turn the FOCUS control through the optimum setting. If the ASTIG adjustment is correctly set, the vertical and horizontal portions of the display will focus at the same position of the FOCUS control. This setting of the ASTIG adjustment should be correct for any display.

1. Install an amplifier unit in the LEFT VERT compartment and a time-base unit in the A HORIZ compartment.
2. Set the VERTICAL MODE switch to LEFT and the HORIZONTAL MODE switch to A.
3. Connect the output of a sine-wave generator to the input of the amplifier unit. Set the sine-wave generator repetition rate to 1 kilohertz and the vertical amplifier deflection factor for a 2-division display.
4. Set the time-base unit sweep rate for 0.2 millisecond/division and the triggering for a stable display. Set the A INTENSITY control so the display is at a usable intensity level (about midrange).
5. Turn the FOCUS control fully counterclockwise and set the ASTIG adjustment to midrange.
6. Set the FOCUS control so the sine-wave trace is as thin as possible.
7. Adjust the ASTIG adjustment so the sine-wave trace is as thin as possible.
8. Repeat steps 6 and 7 for the best overall focus.

BEAMFINDER

The BEAMFINDER helps to locate a display that overscans the crt viewing area vertically and/or horizontally. When the BEAMFINDER button is pressed, the display is compressed and defocused within the graticule area. To locate and reposition an overscanned display, use the following procedure:

Operating Instructions—7904A

1. Press the BEAMFINDER button. While the display is compressed adjust the vertical and horizontal Position controls to center the display. Change the vertical deflection factor until the deflection is about four divisions (the horizontal deflection needs to be reduced to approximately six divisions when operating in an X-Y mode).
2. Release the BEAMFINDER button; the display should remain within the graticule area.

TRACE ALIGNMENT

The TRACE ROTATION adjustment allows the trace to be aligned with the horizontal graticule lines. To adjust TRACE ROTATION, first set the amplifier unit input to ground and then position the trace to the center horizontal graticule line. Adjust the TRACE ROTATION so that the trace is parallel with the center horizontal graticule line. Return the amplifier unit input to AC.

READOUT DISPLAY

The Readout System provides an alphanumeric display of information on the crt along with the analog waveform display. The information displayed by the Readout System is obtained from the plug-in units installed in the plug-in compartments.

The readout information from each channel of the plug-in units is called a word. Up to eight words of readout information can be displayed on the crt (two channels from each of the four plug-in compartments). The location of each readout word is fixed and is directly related to the plug-in unit and channel from which it originated. Figure 2-4 shows the area of the graticule where the readout from each plug-in unit and/or channel is displayed. Notice that the readout from channel 1 of each plug-in unit is displayed in the top division of the graticule and the readout from channel 2 is displayed directly below in the bottom division of the graticule. Usually the readout information for plug in units and/or channels, which are selected by the mode switches, appears in the readout display. (Some special purpose plug-in units may over-ride the mode switches to display readout even though the compartment is not selected for display.)

Readout Identify

An "Identify" feature is provided by the Readout System to correlate the readout word with the originating plug-in unit and channel (amplifier units only). When the "Identify" button of an amplifier unit is pressed, the word IDENTIFY appears in the readout location allocated to that plug-in and channel. Other readout words in the display remain unchanged. When the "Identify" button is released, the readout from this plug-in channel is again displayed. Circuitry may also be provided in the amplifier unit to produce a noticeable

change in the analog waveform display to identify the associated trace when the "Identify" button is pressed (see the plug-in unit manuals for details).

Readout Intensity

The READOUT control determines the intensity of only the readout portion of the display, independently of the other traces. The Readout System is inoperative when the READOUT control is in the fully counterclockwise OFF position. This may be desirable when the top and bottom divisions of the graticule are to be used for waveform display or when the trace interruptions necessary to display characters interfere with the waveform display.

Readout Modes

The READOUT control determines the operating mode of the Readout System. With the READOUT control set to free run (out of OFF or PULSED detent positions) the Readout System operates continually, interrupting the crt display at random (for about 20 microseconds) in order to write each character on the crt. With the READOUT control set to the PULSED position, the Readout System operates in a triggered mode; one complete frame (up to eight words) of readout is displayed. The + GATE/EXT switch determines whether Readout is displayed at the end of the + GATE or when an external signal is applied to the rear-panel GRATICULE/READOUT SINGLE SHOT input connector. The + GATE switch selects whether A time-base gate or B time-base gate triggers the readout.

One frame of readout information is also displayed each time the READOUT MAN (manual) button is pressed.

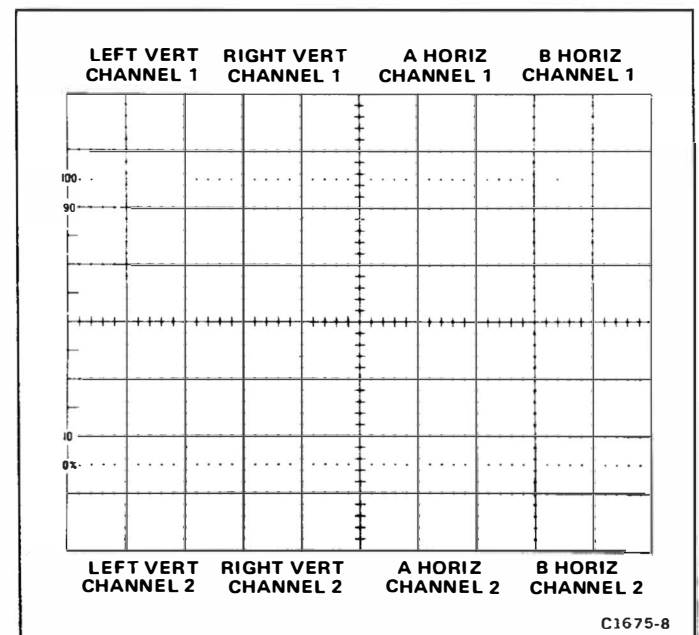

Figure 2-4. Location of readout on the crt identifying the originating plug-in and channel.

The brightness of the readout display, when operating in the PULSED mode, is set by the READOUT PRESET adjustment.

CARE OF CRT SCREEN

The following precautions will prolong the useful life of the crt screen used in this instrument.

1. Use minimum beam intensity to produce a clear, well-defined display.
2. Avoid repeated use of the same area of the screen. If a particular waveform is to be displayed for a long period of time, change the vertical position occasionally to use other portions of the display area.
3. Use minimum READOUT INTENSITY.

VERTICAL AND HORIZONTAL MODE COMBINATIONS

There are 20 possible combinations of VERTICAL MODE and HORIZONTAL MODE switch settings. The possible number of display combinations is further multiplied as follows:

1. The variety of plug-in units available for use with this instrument.
2. The interchangeability of plug-in units (i.e., either an amplifier or a time-base unit can be installed in any compartment).
3. The capabilities of the plug-in units used with this instrument (e.g., a dual-trace amplifier unit can be used in either of the two single-channel modes, in a dual-trace mode, or in an algebraically added mode. A dual time-base unit may be used for an independent sweep or for a delayed sweep in the B Horizontal compartment).

Therefore, it is difficult to list all of the display combinations which can occur during use of the 7904A and available plug-in units. Table 2-1 lists the combination of VERTICAL MODE and HORIZONTAL MODE switch positions available and the type of display obtained with each combination.

Vertical Modes

When the LEFT or RIGHT button of the VERTICAL MODE switch is pressed, only the signal from the plug-in unit in the selected compartment is displayed.

Alternate Mode. The ALT position of the VERTICAL MODE switch produces a display which alternates between the LEFT VERT and RIGHT VERT compartments with each sweep of the crt. Although the ALT mode can be used at all sweep rates, the CHOP

mode provides a more satisfactory display at sweep rates slower than 20 milliseconds/division. At these slower sweep rates, alternate-mode switching becomes perceptible.

Alternate Mode displays have three types of triggering available. When the A and B TRIGGER SOURCE switches are set to the VERT MODE positions, each sweep is triggered by the signal being displayed on the

**TABLE 2-1
Display Combinations¹**

| Vertical Mode | Horizontal Mode | Comments |
|---------------|-----------------|--|
| LEFT | A or B | One trace, vertical deflection from single unit; horizontal deflection from single unit. |
| | ALT or CHOP | Two traces, vertical deflection from single unit; horizontal deflection from both units. |
| ALT | A or B | Two traces, vertical deflection from both units; horizontal deflection from single unit. |
| | ALT or CHOP | Two traces, vertical deflection from both units; horizontal deflection from both units. |
| ADD | A or B | One trace, vertical deflection shows algebraic summation of signals from both units; horizontal deflection from single unit. |
| | ALT or CHOP | Two traces, vertical deflection shows algebraic summation of signals from both units; horizontal deflection from both horizontal compartments. |
| CHOP | A or B | Two traces, vertical deflection shows signals from both units; horizontal deflection from single unit. |
| | ALT or CHOP | Four traces, vertical deflection shows signals from both units; horizontal deflection from both units. |
| RIGHT | A or B | One trace, vertical deflection shows signal from single unit; horizontal deflection from single unit. |
| | ALT or CHOP | Two traces, vertical deflection shows signal from single unit; horizontal deflection from both units. |

¹Combinations given for single-channel vertical and horizontal units only.

Operating Instructions—7904A

crt. This provides a stable display of two unrelated signals, but does not indicate the phase relationship between the signals. In either the LEFT VERT or RIGHT VERT positions of the TRIGGER SOURCE switches, the two signals are displayed showing true time relationship. However, if the signals are not time related, the display from the plug-in that is not providing a trigger signal will be unstable on the crt. The trigger source switches are illuminated indicating the source of the trigger signal.

When the ALT VERTICAL MODE switch is selected and either the ALT or CHOP button of the HORIZONTAL MODE switch is selected, the instrument operates in the slaved-alternate mode. Under this condition, the signal from the LEFT VERT unit is always displayed at the sweep rate of the B HORIZ time-base unit, and the signal from the RIGHT VERT unit is displayed at the sweep rate of the A HORIZ time-base unit (nondelayed sweep only). This results in two displays that are completely independent as to vertical deflection and sweep rate. This display is equivalent to the display obtainable with a dual-beam oscilloscope for most repetitive-display combinations.

In slaved-alternate mode with the A and B TRIGGER SOURCE switches set to VERT MODE the A time-base unit receives a trigger from the right vertical, and the B time-base unit receives a trigger from the left vertical. This is indicated by the illuminated 7904A Trigger Source buttons.

If a delayed-sweep operation is used with this mode, a different sequence is displayed. First, the LEFT VERT unit signal is displayed at the sweep rate of the A HORIZ time-base unit (delaying sweep) and then at the sweep rate of the B HORIZ time-base unit (delayed sweep). The vertical display then shifts to the RIGHT VERT unit and its signal is displayed consecutively at the delaying and delayed sweep rates.

Chopped Mode. The CHOP position of the VERTICAL MODE switch produces a display which is electronically switched between channels at about a one-megahertz rate. In general, the CHOP mode provides the best display at sweep rates slower than about 20 milliseconds/division or whenever dual-trace, single-shot phenomena are to be displayed. At faster sweep rates the chopped switching becomes apparent and may interfere with the display.

When the A or B TRIGGER SOURCE switches are set to VERT MODE, the time-base units are triggered from the left vertical plug-in trigger signal. The LEFT VERT or RIGHT VERT trigger-source positions provide trigger signals to the time-base units from the selected vertical unit only. The trigger source is indicated by the illuminated trigger source pushbuttons. This allows two time-related signals to be displayed showing true-time relationship. (If the signals are not time-related, the

display from the channel that is not providing the trigger signal will appear unstable.)

The CHOP mode can be used to compare two single-shot, transient, or random signals that occur within the time interval determined by the time-base unit (ten times selected sweep rate). To provide correct triggering, the displayed signal which provides the trigger signal must precede the second display in time. Since the signals show true-time relationship, time-difference measurements can be made from the display.

Algebraic Addition. The ADD position of the VERTICAL MODE switch can be used (1) to display the sum or difference of two signals, (2) for common-mode rejection to remove an undesired signal, or (3) for dc offset (applying a dc voltage to one channel to offset the dc component of a signal on the other channel). The isolation between the vertical plug-in compartments is at least 160:1 from dc to 100 megahertz; it decreases to 80:1 from 100 megahertz to 500 megahertz. The overall deflection on the crt in the ADD mode is the algebraic sum of the signals from the vertical plug-in units. It is difficult to determine the voltage amplitude of the resultant display unless the amplitude of the signal applied to one of the plug-ins is known. This is particularly true when the vertical units are set to different deflection factors, since it is not obvious which portion of the display results from the signal applied to a given plug-in unit. The polarity and repetition rate of the applied signals will also affect the ADD display.

The following precautions should be observed when using the ADD mode.

1. Do not exceed the input-voltage ratings of the plug-in units.
2. Do not apply large signals to the plug-in inputs. A good rule is not to apply a signal of more than about eight times the vertical deflection factor. Larger voltages may result in a distorted display.
3. To ensure the greatest dynamic range in the ADD mode, set the position controls of the plug-in units to a setting which would result in a mid-screen display if viewed in the LEFT or RIGHT positions of the VERTICAL MODE switch.
4. For familiar response from each channel, use identical plug-ins and set the plug-in units for the same type of input coupling mode.

Horizontal Modes

When either the A or B button of the HORIZONTAL MODE switch is pressed, the signal is displayed at the sweep rate of the selected time-base unit. Set the applicable INTENSITY control and trigger-source switch for the desired display.

Alternate Mode. The ALT position of the HORIZONTAL MODE switch provides crt sweeps derived alternately from the two time-base units. Although the ALT horizontal mode can be used at all sweep rates, the CHOP mode provides a more satisfactory display at sweep rates slower than about 20 milliseconds/division. At slower sweep rates, the switching between the alternate-mode traces becomes apparent and may interfere with correct analysis of the display.

NOTE

This instrument will not operate in the ALT position of the HORIZONTAL MODE switch if either horizontal plug-in compartment is vacant.

The A and B INTENSITY controls allow individual adjustment of the traces produced by the time-base units in the A HORIZ and B HORIZ compartments. Correct triggering of both time-base units is essential in obtaining the correct display in the ALT horizontal mode. If either of the time-base units does not receive a correct trigger, and therefore does not produce a sweep, the other unit cannot produce a sweep either. This means that one time-base unit cannot begin its sweep until the previous unit has completed its entire display. This can be avoided if the time-base units are set for auto-mode triggering (sweep free-runs if not correctly triggered). See Trigger Source for operation of the A and B TRIGGER SOURCE switches. Also, see Vertical Trace Separation for information on positioning the B HORIZ display when in the ALT dual-sweep mode.

Chopped Mode. When the CHOP button of the HORIZONTAL MODE switch is pressed, the display is electronically switched between the two time-base units at about a 200 kilohertz rate. In general, the CHOP horizontal mode provides the best display when either of the time-base units is set to a sweep rate lower than about 20 milliseconds/division. It also provides the best display when the two time-base units are set to widely differing sweep rates. In the CHOP horizontal mode, equal time segments are displayed from each of the time-base units. This provides a display which does not change greatly, in intensity, as the sweep rate of either time-base unit is reduced (in contrast to ALT HORIZONTAL MODE operation where the slowest trace tends to be the brightest).

The A and B INTENSITY controls allow individual adjustment of the intensity of the traces produced by the time-base units in the A HORIZ and B HORIZ compartments. Triggering is not as critical in the CHOP horizontal mode as in ALT; if one of the units is not triggered properly, only the trace from the untriggered time-base unit is missing from the display. The other trace is presented in the normal manner. See Trigger Source and Vertical Trace Separation for information on

positioning the trace produced by the B HORIZ unit in relation to the trace from the A HORIZ unit.

VERTICAL TRACE SEPARATION

When one of the dual-sweep horizontal modes is selected, the VERT TRACE SEPARATION (B) control allows the trace produced by the B HORIZ sweep to be positioned above or below the trace produced by the A HORIZ sweep. To use the control, first position the trace produced by the A HORIZ plug-in unit. Then adjust the VERT TRACE SEPARATION (B) control to move the trace produced by the B HORIZ plug-in unit away from the A HORIZ display. If both waveforms are larger than four divisions in amplitude, the displays can only be positioned so they do not directly overlap since each waveform cannot be positioned to a unique area of the crt.

TRIGGER SOURCE

The A and B TRIGGER SOURCE switches select the internal trigger signals for the A HORIZ and B HORIZ time-base units. For most applications, these switches can be left in the VERT MODE position. This position is the most convenient since the internal trigger signal is automatically switched as the VERTICAL MODE switch is changed or as the display is electronically switched between the LEFT VERT and RIGHT VERT plug-ins in the ALT VERTICAL MODE switch position. It also provides a usable trigger signal in the ADD position of the VERTICAL MODE switch, since the internal trigger signal in these modes is the algebraic sum of the signals applied to the vertical plug-in units. In the CHOP position, the left vertical plug-in is the trigger source. Therefore, the VERT MODE position ensures that the time-base units receive a trigger signal regardless of the VERTICAL MODE switch setting without the need to change the trigger source selection. The A and B TRIGGER SOURCE switches are illuminated to indicate the source of the trigger signal.

If correct triggering for the desired display is not obtained in the VERT MODE position, the trigger source for either the A HORIZ or B HORIZ time-base unit can be changed to obtain the trigger signal from either the LEFT VERT or RIGHT VERT plug-in. The internal trigger signal is obtained from the selected vertical compartment whether the plug-in in that compartment is selected for display on the crt or not. If the internal trigger signal is obtained from one of the vertical units but the other vertical unit is selected for display, the internal signal must be time-related to the display signal in order to obtain a triggered (stable) display.

CALIBRATOR OUTPUT

The CALIBRATOR provides a convenient signal for checking basic vertical gain and sweep timing. The calibrator signal is also useful for adjusting probe compensation as described in probe instruction

Operating Instructions—7904A

manuals. In addition, the calibrator can be used as a convenient signal source for application to external equipment.

Voltage

The CALIBRATOR provides accurate output voltages of 40 millivolts, 0.4 volt, and 4 volts into high impedance loads (≤ 100 k Ω). In addition, it provides 4 millivolts, 40 millivolts, and 0.4 volt into 50-ohm loads.

Current

The optional current loop accessory provides a 40-milliampere output current (the CALIBRATOR must be set for a 4 volt output), which may be used to check and calibrate current-measuring probe systems. The current signal is obtained by clipping the probe around the current loop (use the current loop adapter accessory part 012-0341-00).

Repetition Rate

The repetition rate of the CALIBRATOR is 1 kilohertz. The calibrator circuit uses frequency-stable components to maintain accurate frequency and a constant duty factor. Thus, the CALIBRATOR can be used for checking the basic sweep timing of time-base units (1-kilohertz rate only).

Wave Shape

The square-wave output signal of the CALIBRATOR can be used as a reference wave shape when checking or adjusting the compensation of high-resistance probes. The square-wave output from the CALIBRATOR has a flat top; any distortion in the displayed waveform is due to the probe compensation.

SIGNAL OUTPUTS

+ Sawtooth Out

The + SAWTOOTH connector provides a positive-going sawtooth signal derived from the time-base unit installed in the A HORIZ compartment or from the time-base unit installed in the B HORIZ compartment.

The front-panel A or B + SAWTOOTH switch determines whether the A HORIZ or the B HORIZ compartment is the source of the + SAWTOOTH output signal. The unit of time for the sawtooth output is determined by the setting of the time-base-unit Time/Division switch. Refer to Table 1-3, in the General Information section for signal parameters.

+ Gate Out

The + GATE connector provides a positive-going rectangular pulse which is derived from a time-base unit installed in either horizontal plug-in compartment. The A or B + GATE switch selects the source of the + GATE signal from the time-base unit installed in the A HORIZ compartment or the B HORIZ compartment. The

duration of the + GATE signal is the same as the duration of the respective unmagnified sweep. The amplitude of the + GATE signal is about 0.5 volt into 50 ohms or about 10 volts into 1 megohm.

Signal Out

The SIG OUT connector provides a sample of the vertical deflection signal. The source of the output signal is determined by the B TRIGGER SOURCE switch. In the VERT MODE position of the B TRIGGER SOURCE switch, the output signal is determined by the setting of the VERTICAL MODE switch. The output signal in the LEFT and RIGHT positions of the VERTICAL MODE switch is obtained only from the selected vertical unit. In the ALT position of the VERTICAL MODE switch, the output signal at the SIG OUT connector switches between signals from the two vertical units, along with the crt display. However, the vertical output signal in the ADD position is a composite signal. In the CHOP position the signal out is derived from the LEFT VERT plug-in. The LEFT VERT and RIGHT VERT positions of the B TRIGGER SOURCE switch are independent of the selection of the VERTICAL MODE switch and provide the vertical output signal only from the selected vertical unit even when it is not selected for display by the VERTICAL MODE switch.

Probe Power

The two PROBE POWER connectors on the rear panel of this instrument provide operating power for active probe systems. It is not recommended that these connectors be used as a power source for applications other than the compatible probes or other accessories which are specifically designed for use with this system.

DISPLAY PHOTOGRAPHY

A permanent record of the crt display can be obtained with an oscilloscope camera system. The instruction manual for the Tektronix oscilloscope cameras include complete instructions for obtaining waveform photographs.

The crt bezel provides integral mounting for Tektronix oscilloscope cameras. The three pins located on the left side of the crt bezel provide power to compatible camera systems. Control signals are also received from Tektronix automatic cameras to allow camera-controlled single-shot photography (see camera manual for further information).

If the readout portion of the display is to be included on waveform photographs, the following suggestions will aid in obtaining good photographs.

1. Focus the crt display. Focus the camera on the readout portion of the crt display. The auto-focus feature of this instrument will maintain the traces at optimum focus.

2. Set the READOUT INTENSITY control for the minimum setting that allows the characters to be written. This normally occurs at a slightly lower intensity level than is necessary for complete writing of the waveform display. Some experimentation may be necessary to establish the correct level. Too high a setting of the READOUT intensity control will result in a broad, poorly defined photograph of the readout display.
3. If single-shot photography is used, set the READOUT and GRAT ILLUM controls to the PULSED position (see Readout Display and Graticule Illumination for complete operating information). This allows, the Readout display and graticule illumination to occur in a single-shot manner after the trace is complete (be sure the camera shutter remains open at least 0.5 second after the sweep is completed to photograph the entire readout and graticule).

INTENSITY MODULATION

Intensity (Z-axis) modulation can be used to relate a third item of electrical phenomena to the vertical (Y-axis) and the horizontal (X-axis) coordinates without affecting the waveshape of the displayed signal. This is accomplished by changing the intensity of the displayed waveform to provide a "gray scale" display.

The voltage amplitude required for visible trace modulation depends on the setting of the A and B INTENSITY controls. A two-volt peak-to-peak signal will completely blank the display even at maximum intensity levels; lower amplitude signals can be used to change only the relative trace brightness. Negative-going signals increase the display intensity and positive-going signals decrease the display intensity. Refer to Table 1-3 in the General Information section for specifications on Z-axis signal requirements.

Time markers applied to the rear-panel Z-AXIS INPUT connector provide a direct time reference on the display. With uncalibrated horizontal sweep or X-Y mode operation, the time markers provide a means of reading time directly from the display. If the markers are not time-related to the display waveform, use a single-sweep display.

REMOTE INPUT SIGNALS

The signal source required to operate the remote input functions on the rear panel can be either active (pulse generator, logic circuit, etc.) or passive (switch or relay). Refer to Table 1-3, in the General Information section for specific parameters on each input.

Remote Single Sweep Reset

An external single-sweep-reset signal can be applied to time-base units installed in the horizontal plug-in

compartments through the rear-panel SINGLE SWEEP RESET input connector. This remote reset function is a duplication of the manually-operated single-sweep reset function (pushbutton) located on the front panel of the 7B-series time-base units.

A and B SINGLE SWEEP READY outputs are provided for external indicators. The indicators signify that the time-base unit has been reset, and is ready to present a single sweep when the next trigger pulse arrives. Refer to Table 1-3, in the General Information section of this manual for signal parameters.

Remote Graticule and Readout Single Shot

The GRATICULE/READOUT SINGLE SHOT bnc connector (located on the rear panel) allows an external signal to actuate one frame of readout information and one momentary illumination of the graticule when the READOUT INTENSITY and GRAT ILLUM controls are set to PULSED, and the +GATE/EXT pushbuttons for READOUT and GRAT ILLUM are set to EXT. Refer to Table 1-3, in the General Information section of this manual, for input requirements.

APPLICATIONS

The 7904A Oscilloscope and associated plug-in units provide a flexible measurement system. The capabilities of the overall system depend mainly upon the plug-in units selected for use with this instrument. Specific applications for the individual plug-in units are described in the plug-in unit instruction manuals. The overall system can also be used for many applications which are not described in detail either in this manual or in the manuals for the individual plug-in units. Contact your Tektronix Field Office or representative for assistance in making specific measurements with this instrument.

VERTICAL AMPLIFIER PLUG-IN UNITS

All 7A-series plug-in units (except the 7A21N unit) can be used with the 7904A. Bandwidth and sensitivity ranges should be taken into consideration when selecting amplifier plug-in units.

Single-Trace

Any single-channel amplifier will display a signal, with the sweep provided by any 7B-series time-base plug-in unit. This combination leaves two unused compartments available for other special purpose units. Blank plug-in panels are available for any unfilled plug-in compartment to reduce electromagnetic interference.

Dual-Trace

A dual-channel amplifier in either vertical compartment can display two separate signals with the other vertical compartment free for other uses.

Three-Trace

A dual-channel amplifier can be used with any single-channel amplifier to display three separate signals. If two time-base plug-in units are used in the horizontal compartments, two signals can be displayed at one sweep rate while the other signal is displayed at the other sweep rate.

Four-Trace

Two dual-channel amplifiers can display four separate signals. If one time-base unit is used, all four signals will be displayed at the same sweep rate.

TIME-BASE PLUG-IN UNITS

The 7904A is compatible with time-base units of the 7B10, 7B70, 7B80 and 7B90 series. Sweep rates and triggering ranges should be taken into consideration when selecting time-base plug-in units.

To obtain a delayed sweep display, a delaying time-base unit must be installed in the A HORIZ compartment and a delayed time-base unit installed in the B HORIZ compartment. A delayed-sweep display can also be obtained with one horizontal compartment if a dual time-base unit is used. This leaves the other horizontal compartment available for other plug-in units as suggested later in this section.

NOTE

The 7B50-series time-base units are not recommended for use with this instrument, because they require a longer delay line than is used in the 7904A. Therefore, the leading edge of the triggering event may not appear on the display.

SAMPLING DISPLAYS

Sampling-system plug-in units for the 7000-series oscilloscopes provide displays of fast-changing signals that cannot be examined using any other method. For example, sampling systems available for the 7904A can resolve repetitive signals having less than 10 millivolts of peak amplitude and occurring in less than 1 nanosecond.

The technique used for sampling is very similar in principle to the use of stroboscopic light to study fast motion. Samples of successive waveforms are taken, amplified by a relatively low-bandwidth amplifier, and then displayed on the crt as a replica of the sampled waveforms.

Three sampling systems are available at this time for the 7904A: (1) the 7S12, which provides time-domain-reflectometry displays and general-purpose sampling measurements, (2) the 7S11/7T11 system and (3) the 7S14, a dual-channel vertical sampling system,

including main and delayed sweep functions. See the Tektronix Products catalog to determine the characteristics of individual units mentioned and of additional units made available after this manual is published.

Single-Trace Sampling

A single-trace sampling display requires either a double-width 7S12 (which includes a time-base), or the 7S11 sampling unit and the 7T11 sampling sweep unit. Direct interconnections between the 7S11 and the 7T11 require these units to be adjacent, with the 7S11 in the RIGHT VERT compartment and the 7T11 in the A HORIZ compartment. If either the 7S12 or the 7S14 is used, it must be located in the middle two compartments to make proper connections with the 7904A.

Dual-Trace Sampling

Two 7S11's can be used with a single sampling time-base unit for time-related displays of two signals. Direct interconnections from the the LEFT VERT 7S11 pass through the RIGHT VERT 7S11 to reach the A HORIZ time-base unit.

The 7S14 is a dual-channel sampling unit with delaying sweep capability. It must be used in the middle two plug-in compartments.

Dual-trace sampling displays can also be made by a 7S12 in the middle two compartments and a 7S11 in the LEFT VERT compartment. In this application, the 7S12 supplies the time-base for both traces.

X-Y Sampling

One 7S11 inserted in the RIGHT VERT compartment and one in the adjacent A HORIZ compartment automatically share a 50 kilohertz free-running strobe condition specified for X-Y displays. The 7S14 has an X-Y operation incorporated as one of its normal mode functions.

SPECIAL PURPOSE PLUG-IN UNITS

The variety of special-purpose plug-in units available allows the 7904A Oscilloscope to be used for many specialized applications. The following is a brief discussion of some of the available special-purpose plug-in units.

Digital Counters and Multimeter Plug-In Units

The digital-multimeter plug-in units measure current, voltage, temperature and resistance; digital-frequency counter plug-in units measure frequency, from dc to above 500 megahertz. These units make use of the readout system to display the measured information on the crt and can function in any compartment, in combination with each other or with any other plug-in units available for use with the 7904A oscilloscope system.

The ability of digital readout plug-in units to operate with other plug-in units makes it possible to process and monitor signals at the same time the digital measurement is being made. For example, by locating a frequency counter in one of the vertical compartments and an amplifier unit in the other vertical compartment, the crt can display the trigger waveform, superimposed on the displayed signal, to indicate the actual triggering point. Or, if the counter is placed in a horizontal compartment, a low-amplitude signal can be applied to a vertical amplifier and amplified before it is internally routed by the trigger source switches to the counter trigger circuit. This allows the unit to be used on signals too small to trigger other counters.

Programmable Digitizer Plug-In Unit

Installation of a Programmable Digitizer plug-in unit, such as a 7D20, adds digital storage and full IEEE 488 bus capabilities to the 7904A Oscilloscope system. Some major features that the Programmable Digitizer provides are multiple waveform storage in digital memory, two cursors for point-to-point measurements, pre- and post-trigger viewing, storage and recall of up to six front-panel settings, and signal averaging to reduce noise. The envelope mode allows subtle variations among random events to be captured and displayed. Waveform storage using digital memory eliminates the need for a storage crt, and also allows viewing information that occurred prior to the triggering event.

In addition, the 7D20 features include a complete alphanumeric crt display of cursor waveform information and measurement values, time base and amplitude settings, trigger position, displayed waveform number, prompts and error messages, and a master menu that allows quick and easy selection of seldom used features.

Complete control of the Waveform Digitizer's functions may be controlled via the IEEE 488 Interface. Commands, waveforms and alphanumeric test messages may be sent or received via the front-panel port.

Readout Access Plug-In Unit

The 7M13 READOUT plug-in unit provides front-panel keyboard operation for convenient access to the crt readout characters. This allows information, such as dates and identifying nomenclature, to be displayed on the crt with the normal crt display. This capability is particularly useful when making photographs.

Transistor Curve-Tracer Plug-In Units

The 7000-series transistor curve-tracer plug-in unit (7CT1N) checks small signal transistors and diodes by producing a display showing the basic characteristic curves for the device being tested. Stepped sweep signals from an internal power supply are applied to the device under test. The resulting output signals are, in

turn, applied to the horizontal and vertical deflection systems of the oscilloscope to plot a family of characteristic curves. This plot can be used to check for damaged transistors and diodes, or to select for special or matched characteristics and to calculate gain, leakage, breakdown voltage, etc.

Spectrum Analyzer Plug-In Units

The 7000-series spectrum analyzer plug-in units display signal amplitudes dispersed over portions of the rf spectrum. Absolute signal energy is plotted on the vertical axis against frequency on the horizontal axis. Applications include waveform and distortion analysis, electromagnetic interference and random noise measurements, filter design, spectrum surveillance, etc.

X-Y OPERATION

In some applications, it is desirable to display one signal versus another (X-Y) rather than against time (interval sweep). The flexibility of the amplifier plug-in units available for use with the 7904A provide the means of applying external signals to the horizontal-deflection system.

The 7904A is shipped from the factory to provide X-Y operation (one amplifier unit in a vertical compartment and one amplifier unit in a horizontal compartment) with Z-Axis control provided by a time-base unit installed in the remaining horizontal compartment (see Fig. 2-5). When an amplifier is installed in a horizontal plug-in compartment, the control of the Z-Axis is switched to the remaining horizontal compartment (in which the time-base unit is installed) as is indicated by the A or B intensity control indicator lights. This is independent of the horizontal mode switch setting. The time-base unit will control the Z-Axis and should be triggered internally from the vertical portion of the X-Y display.

In typical X-Y displays (no time-base unit for Z-Axis control) a dc-driven Z-Axis circuit produces displays with nonuniform brightness. A display may consist of a very dim transition between two bright spots (see Fig. 2-6A). However, when the time-base unit is used, Z-Axis control can be turned on only during the transition and therefore a uniform brightness display may be obtained (see Fig. 2-6B). Z-Axis control is accomplished by increasing the sweep rate until the desired portion of the display is blanked and then using the Triggering Level and Slope controls to view the appropriate portion of the X-Y display. The high horizontal bandwidth of the 7904A used in conjunction with Z-Axis control from a time-base unit allows observation of very fast transitions in X-Y displays.

Option 2, adds a horizontal delay to the instrument permitting signal phase correction between the vertical and horizontal deflection system. Also, some vertical plug-in units have a variable delay function that permits precise phase correction. For further information, refer

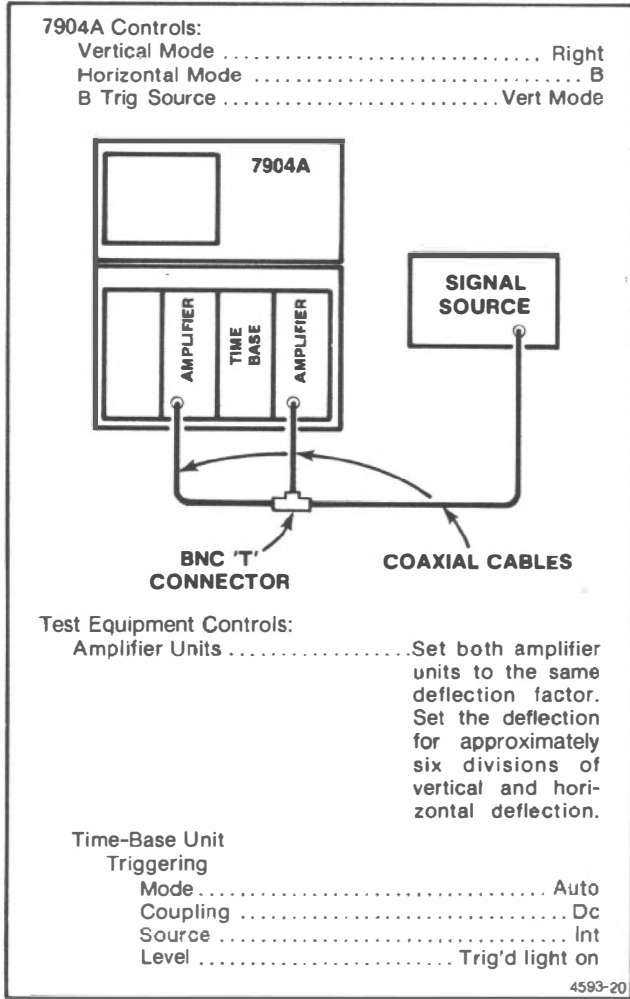

Figure 2-5. Typical Setup for X-Y Displays with Z-Axis Control from time-base unit.

to the horizontal specifications in this manual and to the individual instruction manuals for the amplifier units.

Some of the 7B-series time-base units can be operated as amplifiers in addition to their normal uses as time-base generators. This feature allows an external signal to provide the horizontal deflection to the crt. For most of the time-base units with the amplifier function, the X (horizontal) deflection signal can be connected either to an external input connector on the time-base unit, or it can be routed to the time-base unit through the internal triggering system (see time-base manuals for details). If the latter method is used, the A and B TRIGGER SOURCE switches must be set so that the X (horizontal) deflection signal is obtained from one of the vertical amplifier units and Y (vertical) deflection signal is obtained from the other vertical unit. The attenuator switch on the amplifier unit can provide the horizontal with a preconditioned signal, compatible with the horizontal deflection factor. Also, plug-in units need not be moved from one compartment to another to change from X-Y operation to other modes of operation.

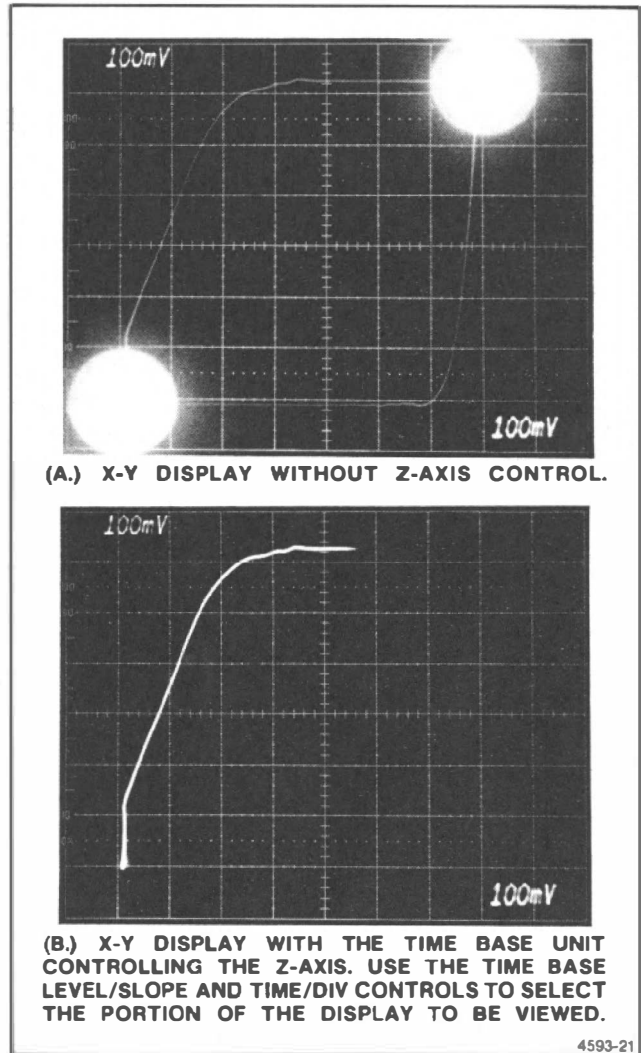

Figure 2-6. Typical X-Y Displays with and without Z-Axis Control.

RASTER DISPLAYS

A raster-type display can be used effectively to increase the apparent sweep length. For this type of display, the trace is deflected both vertically and horizontally by sawtooth signals. This is accomplished in the 7904A by installing a 7B-series time-base unit in one of the vertical plug-in compartments. Normally, the time-base unit in the vertical compartment should be set at a slower sweep rate than the time-base unit in the horizontal compartment; the number of horizontal traces in the raster depends upon the ratio between the two rates.

Information can be displayed on the raster using several different methods. In the ADD position of the VERTICAL MODE switch, the signal from an amplifier unit can be algebraically added to the vertical waveform. With this method, the vertical signal amplitude on the crt should

not exceed the distance between the horizontal lines of the raster. Another method of displaying information on the raster is to use the Z-AXIS INPUT to provide intensity modulation for the display. This type of raster display could be used to provide a television-type display. Complete information on operation using the Z-axis feature is given under Intensity Modulation.

To provide a stable raster display, both time-base units must be correctly triggered. Internal triggering is not provided for the time-base units when they are in the vertical compartments; external triggering must be used. Also, blanking is not provided from the time-base units when they are installed in a vertical compartment.

SERVICING SAFETY SUMMARY

FOR QUALIFIED SERVICE PERSONNEL ONLY

Refer to the Operators Safety Summary

DO NOT SERVICE ALONE

Do not perform internal service or adjustment of this product unless another person capable of rendering first aid and resuscitation is present.

USE CARE WHEN SERVICING WITH POWER ON

Dangerous voltages exist at several points in this product. To avoid personal injury, do not touch exposed connections and components while power is on.

Disconnect power before removing protective panels, soldering, or replacing components.

CRT HANDLING

Use care when handling a crt. Breakage of the crt causes a high-velocity scattering of glass fragments (implosion). Protective clothing and safety glasses should be worn. Avoid striking the crt on any object which might cause it to crack or implode. When storing a crt, place it in a protective carton or set it face down in a protected location on a smooth surface with a soft mat under the faceplate.

USE THE PROPER FUSE

To avoid fire hazard, use only the fuse specified in the parts list for your product, and which is identical in type, voltage rating, and current rating.

THEORY OF OPERATION

This section describes the circuitry used in the 7904A Oscilloscope. The description begins with a discussion of the instrument, using the block diagram shown in Figure 3-1, and continues in detail, showing the relationships between the stages in each major circuit. Schematics of all major circuits are given in Section 8, Diagrams and Circuit Board Illustrations. Stages are outlined, on the schematics, with wide shaded lines. Stage names are in shaded boxes. Refer to these schematics throughout the following circuit description for specific electrical values and relationships.

BLOCK DIAGRAM

The following discussion is provided to assist in understanding the overall concept of the 7904A Oscilloscope mainframe before the individual circuits are discussed in detail. A basic block diagram of the 7904A is shown in Figure 3-1. Only the basic interconnections between the individual blocks are shown on this diagram. Each major circuit within the instrument is given a block. The number of each block refers to the complete circuit diagram located at the rear of this manual.

DESCRIPTION

Vertical signals to be displayed on the crt are applied to the Vertical Channel Switch circuit from both vertical plug-in compartments. The VERTICAL MODE switch is connected to the logic circuit and determines whether the signal from the LEFT VERT or RIGHT VERT compartment is displayed on the crt. The Vertical Channel Switch receives an X-Y inhibit signal from the Readout system to provide the time sharing between the vertical and readout signals.

The selected vertical signal passes through the Delay Line and is amplified by the Vertical Amplifier circuit to drive the vertical deflection plates of the crt (cathode-ray tube). The Vertical Amplifier circuit includes an input from the Readout System to produce the vertical portion of the alpha-numeric readout display.

Horizontal signals for display on the crt are connected to the Horizontal Channel Switch from both horizontal plug-in compartments. The HORIZONTAL MODE switch determines whether the signal from the A HORIZ or B HORIZ compartment is displayed by the crt. The signal from A & B HORIZ plug-in compartments may pass through the optional X-Y delay compensation network (Option 2 instruments only). The Horizontal Channel Switch receives an X-Y inhibit signal from the Readout system to provide the time sharing between the vertical and readout signals.

The selected horizontal signal is amplified by the Horizontal Amplifier circuit to provide horizontal deflection of the crt. The Horizontal Amplifier circuit accepts an input signal from the Readout System to produce the horizontal portion of the alpha-numeric readout display.

The Readout System provides an alpha-numeric display of information encoded by the plug-in unit(s). The readout display is written on the crt on a time-shared basis with the analog waveform display. The VERTICAL and HORIZONTAL MODE switch circuits determine which plug-in unit(s) displays readout information. The Readout system sends inhibit commands to the Vertical Channel Switch, Vertical Amplifier, Horizontal Channel Switch, Horizontal Amplifier, Focus Amplifier and Z-Axis logic circuits. Signals from the Readout System produce the alpha-numeric display for the Vertical, Horizontal and Z-Axis Amplifier circuits.

The Logic circuit develops control signals for use in other circuits within the instrument and the plug-in units. These control signals automatically determine the correct instrument operation in relation to the plug-in units, plug-in unit control settings, and 7904A front-panel control settings. The Logic circuit performs three major functions:

- (1) Receives
 - a. External signals from the Z-Axis Input and the Single-Sweep Reset input.
 - b. Internal signals from the Readout system, the front-panel Mode Switch and Intensity controls, and from all plug-in compartments, through the Main Interface.
- (2) Sends control signals to all plug-in compartments via the Main Interface.
- (3) Develops the Z-Axis signal which drives the Z-Axis Amplifier.

The Z-Axis Amplifier provides the drive signal to control the intensity level of the crt display.

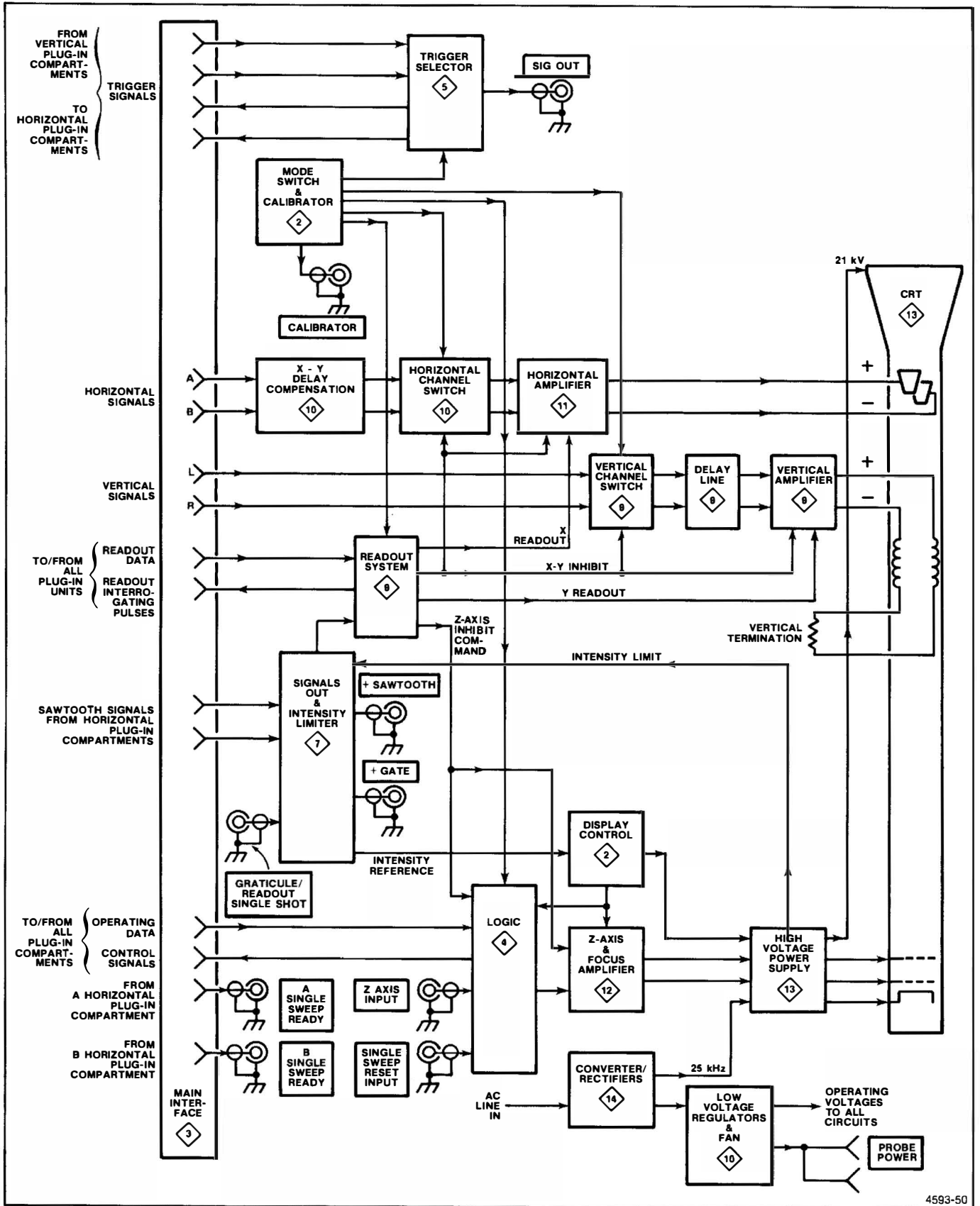

4593-50

Figure 3-1. Basic block diagram of the 7904A Oscilloscope.

The Focus Amplifier provides control voltages to maintain optimum focus of the crt display.

The Crt Circuit contains the control circuits necessary for operation of the crt.

The Display Control circuitry provides front-panel INTENSITY and other crt controls.

The Calibrator circuit produces a one kilohertz square-wave signal which can be used to check the calibration of this instrument and the compensation of probes. The calibrator signal is available as a voltage at the CALIBRATOR connector or as a current through a 40 milliamperere optional current loop accessory.

The internal trigger signals from the vertical plug-in units are connected to the Trigger Selector circuit. The Trigger Selector circuit determines whether the trigger

signal from the left or right vertical unit is connected to the A or B horizontal unit. The B Trigger Channel Switch also produces the drive signal for the SIG OUT circuit to provide an output that is a sample of the vertical signal.

The Signals Out circuit processes signals from the plug-in units for the front-panel +GATE and +SAWTOOTH outputs.

The Intensity Limiter circuit converts Intensity Limit current from the crt Anode Multiplier to an Intensity Reference Voltage for use in the Z-Axis Logic and Auto Focus circuits.

The Control/Rectifier and Low-Voltage Regulator circuits provide the power necessary to operate the instrument. These voltages are connected to all circuits within the instrument.

DETAILED CIRCUIT OPERATION

A detailed description of the electrical operation and relationship of the circuits in the 7904A Oscilloscope mainframe is provided in this section. The theory of operation for circuits unique to this instrument is described in detail in the discussion. Circuits commonly used in the electronics industry are not described in detail. For more information on these commonly used circuits, refer to available textbooks.

LOGIC FUNDAMENTALS

Digital logic techniques are used to perform many functions within the instrument. The function and operation of the logic circuits are described using logic symbology and terminology, which aid in the understanding of these symbols and logic concepts, but is not a comprehensive discussion of the subject. For further information on binary number systems and the associated Boolean algebra concepts, the derivation of logic functions, or a more detailed analysis of digital logic, refer to available textbooks.

SYMBOLS

The operation of circuits in this instrument which use digital techniques is described using the graphic symbols set forth in ANSI standard Y32.14. Table 3-1 provides a basic logic reference for the logic devices used within this instrument. Any deviations from the standard symbology, or devices not defined by the standard, are described in the circuit description for the applicable device.

NOTE

Logic Symbols used on the diagrams depict the logic function as used in this instrument and may differ from the manufacturer's data.

LOGIC POLARITY

All logic functions are described using the positive logic convention. Positive logic is a system of notation where the more positive of two levels (HI) is called the true or 1-state; the more negative level (LO) is called the false or 0-state. The HI-LO method of notation is used in this logic description. The specific voltages that constitute a HI or LO state vary between individual devices. Whenever possible, the input and output lines are named to indicate the function that they perform when at the HI (true) state.







INPUT/OUTPUT TABLES

Input/Output (truth) tables show the input combinations important to a particular function, along with the resultant output conditions. This table may be given either for an individual device or for a complete logic stage. Examples of input/output tables for individual devices can be seen in Table 3-1.

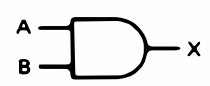
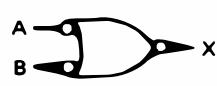
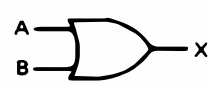
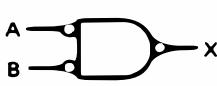
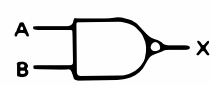
NON-DIGITAL DEVICES

Not all of the integrated circuit devices in this instrument are digital logic devices. The function of non-digital devices is described individually, using operating waveforms or other techniques to illustrate their function.

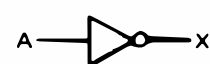
TABLE 3-1
Basic Logic Symbols¹

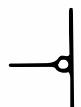
| Basic | | Alternate | | Description of Basic and Alternate Symbols | Truth Tables | | |
|---|---|---|----|--|--------------|----------|----------|
| | | | | | INPUT A | INPUT B | OUTPUT X |
| AND | | | | | | | |
|  |  | A device with two or more inputs & one output. | | LO | LO | LO | |
| | | | | LO | HI | LO | |
| | | | | HI | LO | LO | |
| | | | | HI | HI | HI | |
| OR | | | | | | | |
|  |  | A device with two or more inputs & one output. | | A | B | X | |
| | | | | LO | LO | LO | |
| | | | | LO | HI | HI | |
| | | | | HI | LO | HI | |
| | | HI | HI | HI | | | |
| NAND | | | | | | | |
|  |  | A device with two or more inputs & one output. | | A | B | X | |
| | | | | LO | LO | HI | |
| | | | | LO | HI | HI | |
| | | | | HI | LO | HI | |
| | | HI | HI | LO | | | |
| NOR | | | | | | | |
|  |  | A device with two or more inputs & one output. | | A | B | X | |
| | | | | LO | LO | HI | |
| | | | | LO | HI | LO | |
| | | | | HI | LO | LO | |
| | | HI | HI | LO | | | |
| INVERTER | | | | | | | |
|  |  | A device with one input & one output. The output is always the opposite state of the input. | | A | X | | |
| | | | | LO | HI | | |
| | | HI | LO | | | | |
| Exclusive OR Symbol | | | | | | | |
| |  | A device with two inputs & one output. | | A | B | X | |
| | | | | LO | LO | LO | |
| | | | | LO | HI | HI | |
| | | | | HI | LO | HI | |
| | | HI | HI | LO | | | |
| Negation Indicator Symbol | | | | | | | |
| |  | A small circle at the input or output of a symbol indicates that the LO state is significant. Absence of the circle indicates that the HI state is significant. | | A | B | X | |
| | | | | LO | LO | LO | |
| | | LO | HI | HI | | | |
| | | HI | LO | HI | | | |
| | | HI | HI | LO | | | |

¹The first part of this table includes the alternate way to draw the same gate. The type of symbol used depends on how the gate is used in the circuit. The Basic symbols require an active HI input and the Alternate symbols require an active LO input.

TABLE 3-1 (CONT)
Basic Logic Symbols

| Dynamic Indicator Symbol | Positive Edge-triggered | Negative Edge-triggered | Indicates that this input responds to the indicated transition of the applied signal. |
|--------------------------|-------------------------|-------------------------|---|
| | | | |

RS Flip-Flop

| | <p>When the S input is HI, the Q output will be HI. When the R input is HI, the Q output will be LO. The outputs are complementary except when S & R inputs are both HI.</p> | Input | | Output | |
|--|--|-------|----|-----------------|-----------------|
| | | S | R | Q | Q̄ |
| | | HI | LO | HI | LO |
| | | LO | HI | LO | HI |
| | | HI | HI | HI ² | HI ² |
| | | LO | LO | No Change | |

D-Type Flip-Flop

| | <p>When gated, the state of the Q output changes to the state of the D input prior to the gate. The outputs are complementary.</p> | Input | | Output | |
|--|--|-------|----|-----------|----|
| | | D | C | Q | Q̄ |
| | | LO | ↑ | LO | HI |
| | | HI | ↑ | HI | LO |
| | | HI/LO | LO | No Change | |

Gated J-K Flip-Flop

| | <p>When gated, the outputs change state in response to the states at the inputs prior to the gate. The outputs are complementary. When the C input is LO the J & K inputs are irrelevant.</p> | Input | | | Output | |
|----|---|-------|-----------|----|-----------|----|
| | | C | J | K | Q | Q̄ |
| | | ↑ | LO | LO | No Change | |
| | | ↑ | LO | HI | LO | HI |
| | | ↑ | HI | LO | HI | LO |
| | | ↑ | HI | HI | Toggle | |
| LO | — | — | No Change | | | |

Gated J-K Flip-Flop with Direct Set & Reset Inputs

| | <p>For devices with direct Set & Rest inputs, the indicated state at either of these inputs over-rides all other inputs. J & K inputs have no effect when S or R active signals are present.</p> | Input | | Output | |
|--|--|-------|----|-----------------|-----------------|
| | | S | R | Q | Q̄ |
| | | LO | LO | No Change | |
| | | LO | HI | LO | HI |
| | | HI | LO | HI | LO |
| | | HI | HI | HI ² | HI ² |

²This condition will not persist when one or both S & R inputs return to their inactive level.



INTERCONNECTING DIAGRAM

Diagram 1 shows the cable interconnections between circuit boards within the 7904A.



MODE SWITCH, DISPLAY CONTROL AND CALIBRATOR

A schematic diagram of the Mode Switch, Display Control and Calibrator circuits is given on diagram 2, in section 8 of this manual (Diagrams and Circuit Board Illustrations). The schematic is divided by gray shaded lines separating the circuitry into major stages. These stages aid in locating components mentioned here. Sub-headings use the stage names to further identify portions of the circuitry on diagram 2.

CALIBRATOR

The Calibrator circuit provides voltage outputs of 40 millivolts, 0.4 volt and 4 volts at the CALIBRATOR output connector. A current output of 40 milliamperes is available from the Calibrator circuit with an optional current loop adapter. When using the current loop adapter the Calibrator must be operated only in the 4 V switch position, for stated output.

Transistors Q376 and Q382 form a 1 kilohertz, square-wave oscillator. Oscillation occurs as follows: Initially assume that Q376 is conducting and Q382 is not conducting. The voltage at the emitter of Q382 becomes more negative as C376 discharges through R381. Capacitor C376 discharges until the emitter-base junction of Q382 becomes forward biased. As Q382 begins conducting the oscillator changes states. Regeneration starts when Q382 conducts and C376 stops discharging; this reduces the collector current of Q376. Thus, the collector voltage of Q376 rises positive which causes the base and emitter of Q382 to rise positive. The positive going voltage is coupled by C376 to the emitter of Q376, turning it off.

At this time, Q382 is conducting and Q376 is not conducting. The voltage at the emitter of Q376 goes negative as C376 charges through R376. When the emitter-base junction of Q376 becomes forward biased the oscillator will again change states to complete the cycle.

The square-wave signal produced at the collector of Q382 switches Q384 on and off. When Q384 is on, the current from R383 and R384 flows to ground. When Q384 is off, this current flows through CR386 and R386

into the voltage divider network of R387, R392, R393, R394, R395, R396, and R397 to produce the 4 volt, 0.4 volt and 40 millivolt Calibrator output voltages. The accuracy of the Calibrator output voltage is set by the 0.4 Volts DC adjustment, R385. Both the 4V and 0.4V calibrator switches must be engaged when adjusting R385. The Calibrator frequency is set by the 1 kHz adjustment, R375.

MODE SWITCHING

The Mode Switching circuit includes front-panel switching and selection of the vertical and horizontal compartments to provide crt deflection. The Mode Switch circuit operates in conjunction with the Logic circuit (Diagram 4) to develop control signals for use in other circuits within this instrument and plug-in units installed in the plug-in compartments. Table 3-2 shows the outputs produced with all combinations of the front-panel switch positions.

DISPLAY CONTROL

The Display control circuit includes front-panel controls for the crt, BEAMFINDER switch, and A & B INTENSITY. It also interfaces the Intensity Reference signal through diodes CR2009 and CR2019. For further discussion about the operation of these diodes see Intensity Limiter description on diagram 7.



MAIN INTERFACE

Diagram 3 shows the plug-in interface and the interconnections between the plug-in compartments, circuit boards, etc. of this instrument. The signal and voltage connections of each interface connector are also identified in diagram 3.



LOGIC

A schematic diagram of the Logic circuit is given on Diagram 4, in Section 8 of this manual (Diagrams and Circuit Board Illustrations). The schematic is divided by gray shaded lines separating the circuitry into major stages. These stages aid in locating components mentioned here. Sub-headings in the following discussion use these stage names to further identify portions of the circuitry on Diagram 4.

The Logic circuit develops control signals for use in other circuits within this instrument and any plug-in units installed in the vertical and horizontal compartments. These control signals automatically

TABLE 3-2
Mode Switching Inputs/Outputs

| FRONT-PANEL SWITCH POSITIONS (INPUTS) | | | | | | | | | | | | | | | MODE SWITCHING OUTPUTS | | | | | | | |
|---------------------------------------|-----------|------------|-------------------------|-----------|------------|----------------------|-----|-----|------|-------|------------------------|-----|------|---|-----------------------------|---------------|--------------------|-------|-----|-------------------------------|-----------|------------|
| A TRIGGER SOURCE SWITCH | | | B TRIGGER SOURCE SWITCH | | | VERTICAL MODE SWITCH | | | | | HORIZONTAL MODE SWITCH | | | | A TIME-BASE UNIT DELAY MODE | VERT MODE SIG | HORIZ SLAVE ENABLE | RIGHT | ADD | A AND B TRIGGER SWITCH LIGHTS | | |
| VERT MODE | LEFT VERT | RIGHT VERT | VERT MODE | LEFT VERT | RIGHT VERT | LEFT | ALT | ADD | CHOP | RIGHT | A | ALT | CHOP | B | | | | | | VERT MODE | LEFT VERT | RIGHT VERT |
| | ● | | | ● | | | | | | | | | | | | | LO | HI | | ON | | |
| | | ● | | | ● | | | | | | | | | | | | HI | HI | | | ON | |
| ● | | | ● | | | ● | | | | | | | | | | HI | LO | LO | HI | ON | ON | |
| ● | | | ● | | | | | ● | | | | | | | | HI | LO | LO | LO | ON | ON | ON |
| ● | | | ● | | | | | | ● | | | | | | | CHOP | LO | LO | HI | ON | ON | |
| ● | | | ● | | | | | | | ● | | | | | | LO | LO | HI | HI | ON | | ON |
| ● | | | ● | | | | ● | | | | ● | | | | | ALT | LO | ALT | HI | ON | ON | ON |
| ● | | | ● | | | | ● | | | | | | ● | | | ALT | LO | ALT | HI | ON | ON | ON |
| ● | | | | | | | ● | | | | | ● | | | | ALT | HI | HI | HI | ON | | ON |
| ● | | | | | | | ● | | | | | | ● | | | ALT | HI | HI | HI | ON | | ON |
| | | | ● | | | | ● | | | | | ● | | | | ALT | HI | LO | HI | ON | ON | |
| | | | ● | | | | ● | | | | | | ● | | | ALT | HI | LO | HI | ON | ON | |
| | | | ● | | | | ● | | | | | | | ● | | ALT | LO | ALT | HI | ON | ON | ON |

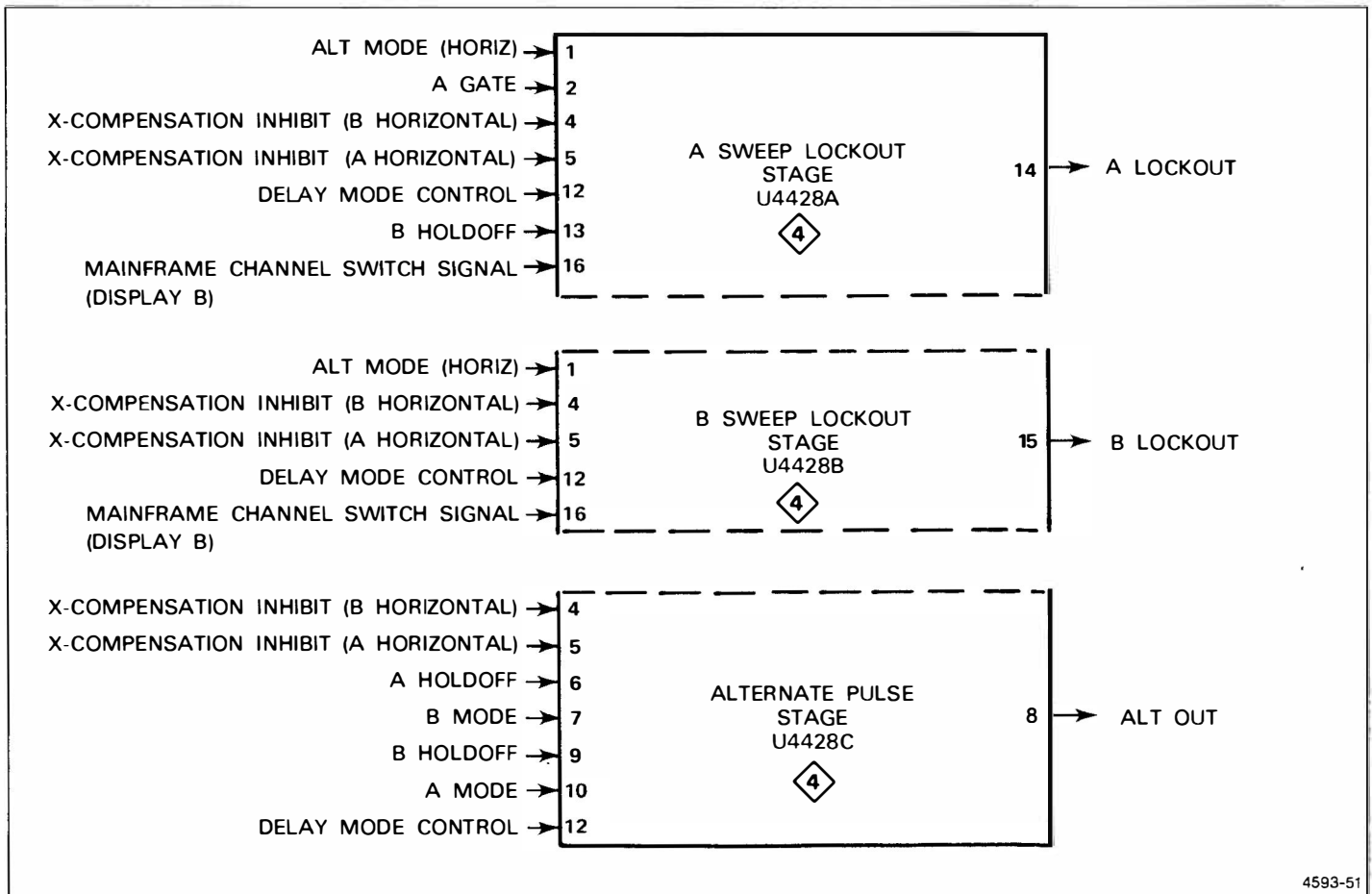

4593-51

Figure 3-2. Breakdown of separate stages within Horizontal Logic IC (U4428).

determine the correct instrument operation in relation to the plug-in units installed or selected, plug-in control settings, and 7904A control settings.

HORIZONTAL LOGIC

The Horizontal Logic stage performs three separate logic functions: A Sweep Lockout, B Sweep Lockout, and Alternate Pulse Generation. The majority of the logic for these functions is contained within the horizontal Logic IC, U4428. Figure 3-2 identifies the three individual stages of U4428 and the input and output terminals associated with each. Note that some of the input signals are connected internally to more than one of the individual stages.

A Sweep Lockout

The A Sweep Lockout portion of the Horizontal Logic IC (U4428) produces an output level at the collector of Q4462 (A Sweep Inhibit) that determines when the A HORIZ time-base unit can produce a sweep. If this output is HI, the A HORIZ unit is locked out (disabled) not producing a sweep. If the level is LO, the A HORIZ unit is enabled and produces a sweep when triggered.

Only two combinations of input conditions to U4428 will produce a HI A Sweep Inhibit level, as shown by Table 3-3. During nondelayed operation, the first combination disables the A Sweep while the B sweep is being displayed in the ALT horizontal mode (both units must be in time-base mode). The second combination disables the A sweep during delayed-sweep operation enabling the B sweep to complete its holdoff before the next A sweep begins.

B Sweep Lockout Stage

The B Sweep Lockout stage produces an output level at the collector of Q4468 determining whether the B HORIZ time-base unit can produce a sweep. A HI output level locks out (inhibits) the B HORIZ unit and a LO level enables the B HORIZ unit to produce a sweep.

The output of this stage is HI only under one set of input conditions to U4428, as shown by Table 3-4. (This set of conditions disables the B sweep while the A sweep is being displayed in the ALT, HORIZONTAL MODE switch position, if both time-base units are in a sweep mode and nondelayed sweep is used.) For any other combination of input conditions, the B Sweep Lockout

TABLE 3-3
Input/Output Combinations for A Lockout (U4428 Pin 14)

| INPUT | | | | | | | OUTPUT |
|------------------------|--------|---------------------------------------|---------------------------------------|--------------------|-----------|-------------------|-----------|
| ALT MODE (HORIZ) | A GATE | X-COMPENSATION INHIBIT (B HORIZONTAL) | X-COMPENSATION INHIBIT (A HORIZONTAL) | DELAY MODE CONTROL | B HOLDOFF | DISPLAY B COMMAND | A LOCKOUT |
| 1 | 2 | 4 | 5 | 12 | 13 | 16 | 14 |
| HI | ϕ | HI | HI | LO | ϕ | HI | HI |
| ϕ | LO | ϕ | ϕ | HI | HI | ϕ | HI |
| ALL OTHER COMBINATIONS | | | | | | | LO |

ϕ = HAS NO EFFECT IN THIS CASE

TABLE 3-4
Input/Output Combinations for B Lockout (U4428 Pin 15)

| INPUT | | | | | OUTPUT |
|------------------------|---------------------------------------|---------------------------------------|--------------------|-------------------|-----------|
| ALT MODE (HORIZ) | X-COMPENSATION INHIBIT (B HORIZONTAL) | X-COMPENSATION INHIBIT (A HORIZONTAL) | DELAY MODE CONTROL | DISPLAY B COMMAND | B LOCKOUT |
| 1 | 4 | 5 | 12 | 16 | 15 |
| HI | HI | HI | LO | LO | HI |
| ALL OTHER COMBINATIONS | | | | | LO |

level is determined by the Delay Gate (from A time-base unit); see main Interface, diagram 3.

Alternate Pulse Generator

The third function of the Horizontal Logic stage is to produce an Alternate Pulse signal for use by the Plug-In Binary and Vertical Binary stages. The holdoff gate produced at the end of the sweep by the respective time-base unit is differentiated by either C4335 or C4423, providing a positive-going pulse to pin 6 or 9 of U4428. The differentiated A or B holdoff gate may produce the alternate pulse depending upon the operating conditions as shown in Table 3-5.

The following sections describe the operation of the Alternate Pulse Generator stage for the various combinations of input conditions shown in Table 3-5:

(1) A (Only) Mode

An Alternate Pulse is produced at the end of each A sweep when the HORIZONTAL MODE switch is set to the A position.

(2) B (Only) Mode

In the B position of the HORIZONTAL MODE switch, an Alternate Pulse is produced at the end of each B sweep. (The A time-base must be in independent, nondelayed mode.)

TABLE 3-5
Input/Output Combinations for Alternate Pulse (U4428 Pin 8)

| INPUT | | | | | | | OUTPUT | |
|---|---|-----------------|--------|-----------------|--------|-----------------------|--|---|
| X-COMPENSATION INHIBIT (B HORIZONTAL) | X-COMPENSATION INHIBIT (A HORIZONTAL) | A HOLDOFF | B MODE | B HOLDOFF | A MODE | DELAY MODE CONTROL | TIME-BASE WHICH IS SOURCE OF ALTERNATE PULSE | HORIZONTAL CONDITIONS |
| 4 | 5 | 6 | 7 | 9 | 10 | 12 | B ² | |
| HI | Φ | HI ¹ | LO | Φ | HI | Φ | A | A ONLY |
| Φ | HI | Φ | HI | HI ¹ | LO | LO | B | B ONLY |
| HI | HI | HI ¹ | LO | HI ¹ | LO | LO | A AND B | ALT OR CHOP |
| HI | HI | HI ¹ | Φ | Φ | Φ | HI | A | A DELAYS B |
| HI | LO | HI ¹ | LO | LO | Φ | Φ | A | A WITH VERTICAL UNIT IN B COMPARTMENT. |
| LO | HI | LO | Φ | HI ¹ | LO | LO | B | B WITH VERTICAL UNIT IN A COMPARTMENT. |
| ALL OTHER COMBINATIONS | | | | | | | NO OUTPUT PULSE (LO AT OUTPUT) | |

Φ = Has no effect in this case.

¹Positive-going pulse. Where both A and B Holdoff are required to be HI, a HI at either input produces an alternate pulse.

²Negative-going pulse.

(3) Alt or Chop Mode

When the HORIZONTAL MODE switch is set to ALT or CHOP (the A time-base unit must be in independent, nondelayed mode), an Alternate Pulse is produced at the end of each sweep. For example, an Alternate Pulse is produced at the end of the A sweep, then at the end of the B sweep, again at the end of the A sweep, etc. Although Alternate Pulses are also produced in the CHOP horizontal mode, they are not used in this instrument.

(4) Delayed Sweep (A Delays B)

When the A time-base unit is set for delayed operation, the Alternate Pulse Generator produces an Alternate Pulse only at the end of the A Sweep, even when the HORIZONTAL MODE switch is set to B. This is necessary since the A time-base sets the delay time for the B time-base unit whenever B is displayed.

(5) Amplifier Unit In Horizontal Compartment

When an amplifier unit is installed in either of the horizontal plug-in compartments, the Alternate Pulse can be produced only from the remaining time-base unit. If amplifier units are installed in both horizontal compartments, an Alternate Pulse is not produced since there are no time-base units to produce a holdoff pulse.

Z-AXIS LOGIC

The Z-Axis Logic stage produces an output current signal at pin 8 of U4485 which sets the intensity of the crt display (except for the readout display which is controlled by the Readout System.) The output current at pin 8 is determined by the setting of the A or B INTENSITY controls, and the Auxiliary Z-Axis input. The Auxiliary Z-Axis input is produced by either the External Z-Axis input or by an input from any of the plug-in units; see Main Interface, diagram 3. The input current from the A and B INTENSITY controls is switched for proper timing with the output to the horizontal display. The Vertical Chopped Blanking, Horizontal Chopped Blanking, and Readout Blanking signals are applied to this stage to block the output current and blank the crt display for vertical chopping, horizontal chopping, or during a readout display.

The inputs to the Z-Axis Logic stage (U4485) pin 1, 2, 9, and 16 are current-driven and are variable from zero to four milliamperes.

The Vertical Chopped Blanking, Horizontal Chopped Blanking and Z-Axis Inhibit signals enable or disable this stage to control all output current. Quiescently, the level at pins 6 and 7 is HI so that the intensity current from pins 1, 2, 9, and 16 can pass to the output. However, both pins 6 and 7 go LO during Vertical Chopped Blanking, during Horizontal Chopped

Blanking or during a readout display. This blocks the output current and blanks the crt. The Vertical Chopped Blanking signal is connected to pins 6 and 7 of U4485 directly from pin 4 of U4320. The Horizontal Chopped Blanking Inhibit signal is connected to U4485 from pin 4 of U4340 through LR4338, Q4336 and CR4471. Notice that this signal is connected to the collector of Q4336. This transistor is normally operating in the saturated condition, and the HI Horizontal Chopped Blanking Inhibit level from U4340 is the collector source voltage. When the Horizontal Chopped Blanking Inhibit level goes LO, the current through Q4336 drops producing a corresponding LO level at its emitter. This level is connected to pins 6 and 7 of U4485 through CR4471.

Transistor Q4336 also controls the levels at pins 6 and 7 for readout displays. The Z-Axis Inhibit from the Readout System is connected to the base of Q4336 through VR4334 and R4335. This level is normally HI, so Q4336 operates as controlled by the Horizontal Chopped Blanking Inhibit level at its collector. When a readout display is to be presented, the Z-Axis Inhibit level drops LO and is coupled to the base of Q4336 through VR4334. Transistor Q4336 is then reverse biased producing, a LO level at its emitter. This level, coupled to pins 6 and 7 of U4485 through CR4471, blocks the Z-Axis Logic output current during the readout display. (The intensity of the readout display is determined by a separate Readout intensity level connected directly to the Z-Axis Amplifier; see CRT Circuit description.) Diode CR4472 clamps the emitter of Q4336 at about -0.6 volt when the transistor is off.

The A INTENSITY control sets the output current level when the A Gate at pin 14 U4485 is HI and the Display B Command (connected to pin 15 through Q4488 and Q4492) is LO. The A Intensity current is blocked whenever the A Gate level goes LO (indicating that the A sweep is complete) or the Display B Command goes HI (indicating that the B sweep is being displayed.) The current from the A INTENSITY control is connected to pin 16 through R4482.

In the delayed mode, current is added to the A INTENSITY current during the A-sweep time to intensify a portion of the trace. This intensified portion is coincident with the B-sweep time indicating which portion of the A sweep is displayed in the delayed mode. The A Intensified current is supplied to pin 2 of U4485 from the A INTENSITY control through Q4480 & R4481. With this configuration, the intensified current increases as the A INTENSITY control setting is advanced. This provides a proportional intensity increase in the intensified zone as the overall A-sweep intensity increases. Therefore, the intensified zone is more readily visible at high intensity levels. A front-panel screwdriver adjustment (B CONTRAST, R2015) sets optimum contrast between the intensified portion and the overall sweep. The intensified current is added to the A INTENSITY current, producing an intensified zone on

the A sweep under the following conditions: HI A Gate level at pin 14, LO Display B Command at pin 15, HI B Gate level at pin 4, and HI Delay Mode Control Out level at pin 5.

The B INTENSITY control determines the output current when the B Gate level at pin 4 and the Display B Command at pin 15 are both HI. The current from the B INTENSITY control is connected to the Z-Axis Logic stage through R4483.

The current level established by the intensity controls can be altered by the Auxiliary Z-Axis current level at pin 9. The current at this pin can come from the Z-AXIS INPUT connector on the rear panel (see Diagram 3) or from any of the plug-in compartments. This current either increases or decreases (depending on polarity) the output current to modulate the intensity of the display. Input from the Z-AXIS INPUT connector allows the trace to be modulated by external signals. The Auxiliary Z-Axis inputs from the plug-in compartments allow special-purpose plug-in units to modulate the display intensity. Diodes CR4473 and CR4474 limit the maximum voltage change at pin 9 to about + and -0.6 volt to protect the Z-Axis Logic stage if an excessive voltage is applied to the Z AXIS INPUT connector. Table 3-6 shows Input/Output combinations of the Z-Axis Logic stage.

HORIZONTAL BINARY

The Horizontal Binary stage develops the Display B Command to indicate which horizontal plug-in unit is providing the displayed sweep. When the level is HI, the B horizontal unit is displayed; when it is LO, the A horizontal unit is displayed.

The Display B Command is used in the following stages within the Logic circuit: Horizontal Logic (A and B Sweep Inhibit), Z-Axis Logic, Vertical Binary, and Trace Separation. In addition, it is connected to the following circuits elsewhere in the instrument to indicate which horizontal unit is to be displayed: Main Interface (A and B HORIZ plug-in compartments), Horizontal Interface (for horizontal channel selection).

The levels on pins 3, 4, 7, and 10 of U4358 are determined by the HORIZONTAL MODE switch (see diagram 2). A HI output level on one of four output lines indicates which horizontal mode has been selected. The remaining lines are LO.

The Horizontal Binary stage operates as follows for each 4 positions of the HORIZONTAL MODE switch (refer to Table 3-7 for input/output conditions):

1. A MODE. By setting the HORIZONTAL MODE switch to A, the Display B Command is LO, indicating to all circuits that the A horizontal unit is to be displayed.

TABLE 3-6
Input/Output Combinations for the Z-Axis Logic Stage

| A INTENSITY | B INTENSITY | INTENSIFIED | A GATE | B GATE | DELAY MODE CONTROL | DISPLAY B COMMAND | Z-AXIS SIGNAL | SOURCE OF Z-AXIS SIGNAL |
|--------------------|-------------|-------------|--------|--------|--------------------|-------------------|---------------|------------------------------|
| 16 | 1 | 2 | 14 | 4 | 5 | 15 | 8 | |
| VAR | Φ | Φ | HI | Φ | LO | LO | VAR | A INTENSITY |
| VAR | Φ | Φ | HI | LO | HI | LO | VAR | A INTENSITY |
| VAR | Φ | VAR | HI | HI | HI | LO | VAR | A INTENSITY PLUS INTENSIFIED |
| Φ | VAR | Φ | Φ | HI | Φ | HI | VAR | B INTENSITY |
| OTHER COMBINATIONS | | | | | | | LO | NO OUTPUT |

HI = MAX VOLTAGE OR CURRENT
 LO = MIN VOLTAGE OR CURRENT
 VAR = VARIABLE CURRENT, 0 to 4 mA

Φ = HAS NO EFFECT

TABLE 3-7
Input/Output Combinations of the Horizontal Binary Stage

| INPUT | | | | | | | OUTPUT |
|-----------------------------|--------|--------|--------|-----------------|-------------------|-------------------|---------------------------|
| HORIZONTAL CHOPPED BLANKING | A MODE | B MODE | B MODE | ALTERNATE PULSE | CHOP MODE (HORIZ) | DISPLAY B COMMAND | |
| 1 | 3 | 4 | 7 | 8 | 10 | 6 | |
| Φ | HI | LO | LO | Φ | LO | LO | HORIZONTAL DISPLAY |
| Φ | LO | HI | HI | Φ | LO | HI | A HORIZONTAL UNIT |
| LO ¹ | LO | LO | LO | Φ | HI | n+1 ² | B HORIZONTAL UNIT |
| Φ | LO | LO | LO | LO ¹ | LO | n+1 ³ | CHOP BETWEEN A AND B |
| | | | | | | | ALTERNATE BETWEEN A AND B |

Φ = Has no effect in this case.

n+1 = If output is LO prior to LO¹, it goes HI, and vice versa.

¹Actuated by negative-going edge.

²Repetition rate one-half horizontal chopped blanking rate.

³Repetition rate one-half alternate pulse rate.

2. B MODE. Selecting the B horizontal mode provides a HI Display B Command to all circuits.

3. CHOP MODE. In the CHOP position of the HORIZONTAL MODE switch, the Display B Command switches between the HI and LO levels producing a display that switches between the A and B horizontal units at a 0.2-megahertz rate. The repetition rate of the Display B Command in this mode is determined by the Horizontal Chopped Blanking pulse (see Chop Counter

description later in this section). Each time the Horizontal Chopped Blanking pulse at pin 1 U4358 drops LO, the output at pin 6 switches to the opposite state.

4. ALT MODE. For ALT horizontal operation, the Display B Command switches to the opposite state each time the negative portion of the Alternate pulse is received from the Horizontal Logic stage. Repetition rate of the Display B Command in this mode is one-half the repetition rate of the Alternate pulse applied to pin 8.

VERTICAL BINARY

The Vertical Binary stage produces the Vertical Alternate Command at pin 6 to determine which vertical unit will be displayed when the VERTICAL MODE switch is set for ALT. When this output level is HI, the RIGHT VERT unit is displayed; when it is LO, the LEFT VERT unit is displayed. In the ALT or CHOP positions of the HORIZONTAL MODE switch (nondelayed operation only), the output of this stage is slaved to the output of the Horizontal Binary stage so that the Vertical Alternate Command is always HI when the Display B Command is LO, and vice versa. This action allows independent-pairs operation (sweep-slaving) in the ALT position of the VERTICAL MODE switch and the ALT or CHOP positions of the HORIZONTAL MODE switch, whereby the LEFT VERT unit is always displayed at the sweep rate of the B time-base and the RIGHT VERT unit is displayed at the sweep rate of the A time-base. Thus, independent-pairs operation can simulate dual-beam operation for repetitive sweeps.

When the A time-base unit is set to the delaying mode, the repetition rate of the Vertical Alternate command is one-half the repetition rate of the Display B Command. Consequently, each vertical unit is displayed first against the A time-base unit (delaying), then the B time-base unit (delayed), before the display is switched to the other vertical unit.

The Vertical Alternate Command is used in the Plug-In Binary and Vertical Mode Logic stages. The Vertical Binary stage (U4368) uses the same type of IC as the Horizontal Binary stage. Notice the Display B command level at pin 7. This input is the inverse of the Display B command level at pin 8 (Q4364 establishes the Display B Command level). Also, notice the line connected to pin 4 of the Vertical Binary IC U4368. The level at pin 4, Horiz Slave Enable, is established by Q4424, and is HI only when the HORIZONTAL MODE switch is set for ALT or CHOP and the time-base units are in nondelayed operation. The Vertical Binary IC uses the information at pin 4 for correct slaving of the Vertical Alternate Command to the Display B Command (necessary for independent-pairs operation). Horizontal Slave Enable is also used by the trigger select logic.

The operation of the Vertical Binary stage in relation to the modes of operation that can occur is described in the following:

1. A OR B MODE. When the HORIZONTAL MODE switch is set to either A or B, the Vertical Alternate Command switches to the opposite state each time an Alternate Pulse is received from the Horizontal Logic stage. Repetition rate of the Vertical Alternate Command in this mode is one-half the repetition rate of the Alternate Pulse. The input conditions for these modes are:

Pin 1 LO—Alternate Pulse generated by Horizontal Logic stage goes negative.

Pin 4 Horizontal Slave Enable LO—(HORIZONTAL MODE switch in any position except ALT or CHOP, or the A time-base unit is set for delayed sweep.)

Pin 10 HI—HORIZONTAL MODE switch set to A or B.

2. ALT OR CHOP MODE (HORIZ): NONDELAYED.

In the ALT or CHOP positions of the HORIZONTAL MODE switch, the output level at pin 6 is the same as the Display B Command level at pin 7. The Display B Command level is produced by inverting the Display B Command from the Horizontal Binary stage. Therefore, the repetition rate of the output signal is the same as the Display B Command. With the VERTICAL MODE switch set to ALT and the A time-base unit set for nondelayed operation, the result is that the RIGHT VERT unit is always displayed at the sweep rate of the A time-base unit, and the LEFT VERT unit is always displayed at the sweep rate of the B time-base unit (independent-pairs operation or sweep slaving). The input conditions which provide a HI output level so that the RIGHT VERT unit can be displayed at the A sweep rate are:

Pin 4 Horizontal Slave Enable HI—(HORIZONTAL MODE switch set to ALT or CHOP with nondelayed sweep).

Pin 7 HI—The A sweep is to be displayed (Display B Command LO).

Pin 10 LO—HORIZONTAL MODE switch set to any position except A or B.

The input conditions which provide a LO output level so that the LEFT VERT unit can be displayed at the B-sweep rate are:

Pin 4 Horizontal Slave Enable HI—(HORIZONTAL MODE switch set to ALT or CHOP with nondelayed sweep.)

Pin 7 LO—The B sweep is to be displayed (Display B Command HI).

Pin 10 LO—HORIZONTAL MODE switch set to any position except A or B.

3. ALT OR CHOP MODE (HORIZ): DELAYED.

If the A time-base unit is set to the delayed mode when the HORIZONTAL MODE switch is set to either ALT or CHOP, the operation of the stage is changed from that discussed above. Now, the Vertical Alternate Command switches between the HI and LO states at a rate that is one-half the repetition rate of the Display B Command. The resultant crt display in the ALT position of the VERTICAL MODE switch allows the RIGHT VERT unit to be displayed first against the A sweep (delaying) and then against the B sweep (delayed). Then the display switches to the LEFT VERT unit and is displayed

TABLE 3-8
Input/Output Combinations for the Vertical Binary Stage

| INPUT | | | | | | OUTPUT |
|-----------------|--------------------|-------------------|-------------------|-------------|----------------------------|---------------------------|
| ALTERNATE PULSE | HORIZ SLAVE ENABLE | DISPLAY B COMMAND | DISPLAY B COMMAND | A OR B MODE | VERTICAL ALTERNATE COMMAND | |
| 1 | 4 | 7 | 8 | 10 | 6 | HORIZONTAL MODE SWITCH |
| LO ¹ | LO | Φ | Φ | HI | n+1 ² | A OR B |
| Φ | HI | HI | LO | LO | HI | DISPLAY RIGHT |
| Φ | HI | LO | HI | LO | LO | DISPLAY LEFT |
| Φ | LO | Φ | LO ¹ | LO | n+1 ³ | ALT OR CHOP, DELAYED MODE |

Φ = Has no effect in this case.

n+1 = If output is LO prior to LO¹ it goes HI, and vice versa.

¹Actuated by negative-going edge.

²Repetition rate one-half alternate pulse rate.

³Repetition rate one-half display B rate.

consecutively against the A and B sweeps in the same manner. The input conditions for this mode of operation are:

Pin 4 Horizontal Slave Enable LO—(The A time-base unit set for delayed operation.)

Pin 8 HI or LO—Vertical Alternate Command changes state at HI to LO transition of Display B Command.

Pin 10 LO—HORIZONTAL MODE switch set to any position except A or B.

Table 3-8 shows the input/output combinations for the Vertical Binary stage.

PLUG-IN BINARY

The Plug-In Binary stage produces the Plug-in Alternate Command to alternate dual-trace units. The Plug-In Binary stage, U4412, uses the same type of integrated circuit as the Horizontal Binary and Vertical Binary stages.

When the Plug-In Alternate Command level is HI and the plug-in unit is set for alternate operation, Channel 2 of the dual-trace unit is displayed. When it is LO, Channel 1 is displayed. The repetition rate of the Plug-In Alternate Command is determined by the setting of the VERTICAL MODE switch. For all positions of the VERTICAL MODE switch except ALT, the Plug-In Alternate Command is the same as the VERT

ALTERNATE Command at pin 6 of U4368 (Vertical Binary stage). Since Vertical Alternate Command is derived directly from the Display B Command, this allows the two channels of a dual-trace vertical unit to be slaved to the time-base units (nondelayed, dual-sweep horizontal modes only) in the same manner as previously described for independent-pairs operation between the vertical and time-base units. The resultant crt presentation, when the dual-trace unit is set for alternate operation, displays the Channel 1 trace at the sweep rate of the B time-base unit and the Channel 2 trace at the sweep rate of the A time-base unit.

The Plug-In Alternate Command switches from HI to LO as the Display B Command (from the Horizontal Binary stage) switches from LO to HI, and vice versa.

When the VERTICAL MODE switch is set to ALT, pin 6 of the Vertical Binary stage switches the vertical display between the two vertical units. However, if either of the vertical plug-in units are dual-trace units, they can be operated in the alternate mode also. To provide a switching command to these units, the Plug-In Binary stage produces an output signal with a repetition rate that is one-half the repetition rate of the signal at pin 6 of U4368. The sequence of operation, when two dual-trace vertical units are installed in the vertical plug-in compartments and are both set for alternate operation, is as follows (VERTICAL MODE and HORIZONTAL MODE switches set to ALT):

1. Channel 1 of LEFT VERT unit at sweep rate of B time-base unit;

TABLE 3-9
Input/Output Combinations for the Plug-In Binary Stage

| INPUT | | | | OUTPUT | COMMENTS |
|-------------------------|----------------------------|----------------------------|---------------------------|--------|---------------------|
| ALT MODE INHIBIT (VERT) | VERTICAL ALTERNATE COMMAND | VERTICAL ALTERNATE COMMAND | PLUG-IN ALTERNATE COMMAND | | |
| 4 | 7 | 8 | 6 | | |
| LO | Φ | LO ¹ | n+1 ² | | ALT VERTICAL MODE |
| HI | LO | Φ | LO | | CHANNEL 1 DISPLAYED |
| HI | HI | Φ | HI | | CHANNEL 2 DISPLAYED |

Φ = Has no effect in this case.

n+1 = If output is LO prior to LO¹ it goes HI, and vice versa.

¹Actuated by negative-going edge.

²Repetition rate one-half Vertical Alternate Command rate.

2. Channel 1 of RIGHT VERT unit at sweep rate of A time-base unit;
3. Channel 2 of LEFT VERT unit at sweep rate of B time-base unit;
4. Channel 2 of RIGHT VERT unit at sweep rate of A time-base unit.

Notice that under these conditions, both channels of the LEFT VERT unit are displayed at the B-sweep rate and that both channels of the RIGHT VERT unit are displayed at the A-sweep rate. Input conditions when the VERTICAL MODE switch is set at ALT are:

Pin 4 LO—VERTICAL MODE switch set to ALT.

Pin 8 HI or LO—Plug-In Alternate Command signal changes state during HI to LO transition of the Vertical Alternate Command signal.

Table 3-9 gives the input/output combinations for the Plug-In Binary stage.

VERTICAL CHOPPED BLANKING

Part of integrated circuit U4320, along with the external components shown in Figure 3-3, make up the clock generator stage. Component parts R1, Q1, Q2, and Q3 represent an equivalent circuit within U4320. This circuit, along with discrete components C4314-R4312-R4313-R4314, compose a two-megahertz free-running oscillator to provide a timing (clock) signal which synchronizes the vertical, horizontal, and plug-in, chopping modes.

This stage operates as follows: Assume that Q2 is conducting and Q1 is off. The collector current of Q2 produces a voltage drop across R1 to turn off Q1. This negative level at the collector of Q2 is also connected to pin 14 through Q3 (see waveforms in Fig. 3-3B at time T⁰). Since there is no current through Q1, C4314 begins to charge towards -15 volts through R4312-R4313. The emitter of Q1 goes negative as C4314 charges, until it reaches a level about 0.6 volts more negative than the level at its base. Then Q1 is forward biased and its emitter rapidly rises positive (see Time T¹ on waveforms). Since C4314 cannot change its charge instantaneously, the sudden change in voltage at the emitter of Q1 pulls the emitter of Q2 positive. With Q2 reverse biased, its collector rises positive to produce a positive output level at pin 14.

Now, conditions are reversed. Since Q2 is reverse biased, there is no current through it. Therefore, C4314 can begin to discharge through R4314. The emitter level of Q2 follows the discharge of C4314, until it reaches a level of about 0.6 volt more negative than its base. Then Q2 is forward biased and its collector drops negative to reverse-bias Q1. The level at pin 14 drops negative also, to complete the cycle. Once again, C4314 begins to charge through R4312-R4313 to start the second cycle. Two outputs are provided from this oscillator. The Delay Ramp signal from the junction of R4312-R4313 is connected to the Vertical Chopped Blanking stage. This signal has the same waveshape as the waveform at pin 13; its slope is determined by the divider ratio between R4312-R4313. A wide pulse train output is provided at pin 14. The frequency of this pulse train is determined by the overall RC relationship between C4314-R4312-

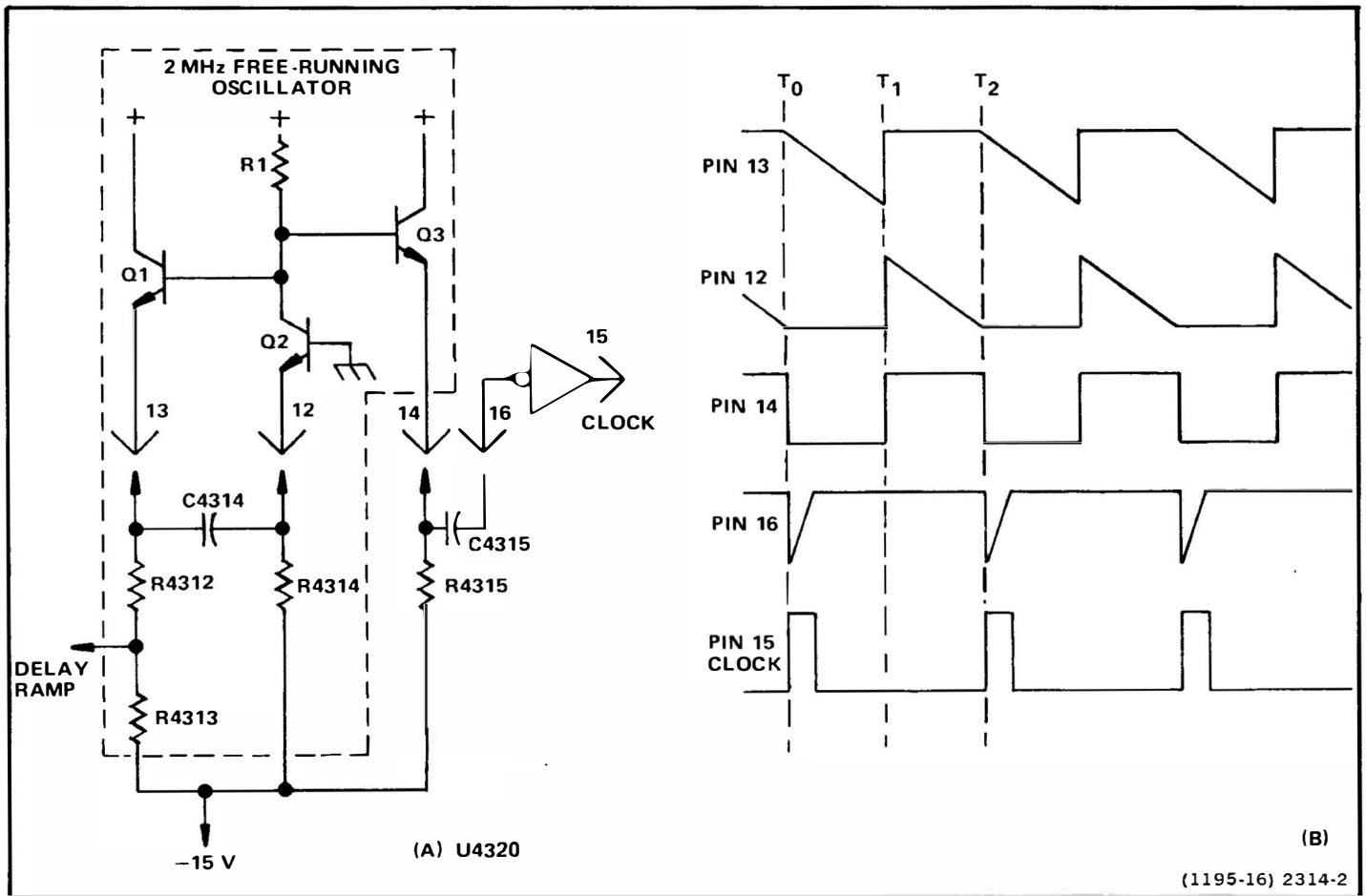

Figure 3-3. (A) Diagram of clock generator stage; (B) Idealized waveforms for clock generator stage.

R4313-R4314, and its duty cycle is determined by the ratio of R4312 and R4313 to R4314.

The pulse train at pin 14 is connected to pin 16 through C4315. Capacitor C4315, along with the internal resistance of U4320, differentiates the pulse train at pin 14 to produce a narrow negative-going pulse coincident with the falling edge of the pulse train (positive-going pulse coincident with rising edge has no effect on circuit operation). This negative-going pulse is connected to pin 15 through an inverter-shaper circuit that is also part of U4320. The output at pin 15 is a positive-going clock pulse with a repetition rate of about two megahertz.

The Vertical Chopped Blanking stage is made up of the remainder of U4320. This stage determines if Vertical Chopped Blanking pulses are required, based upon the operating mode of the vertical system or the plug-in units (dual-trace units only). Vertical Chopped Blanking pulses are produced if: 1. VERTICAL MODE switch is set to CHOP; 2. Dual-trace vertical unit is operating in the chopped mode and that unit is being displayed. The repetition rate of the negative-going Vertical Chopped Blanking pulse output at pin 4 is a two megahertz for all of the above conditions as determined by the clock

generator stage. Table 3-10 shows the input/output combinations for the Vertical Chopped Blanking stage.

The delay ramp signal from the clock generator stage determines the repetition rate and pulse width of the Vertical Chopped Blanking pulses. The delay ramp from pin 13 (U4320) applied to pin 10 starts to go negative from a level of about +1.1 volts, coincident with the leading edge of the clock pulse (see waveforms in Fig. 3-4). This results in a HI quiescent condition for the Vertical Chopped Blanking pulse. The slope of the negative-going delay ramp is determined by the clock generator stage. As it reaches a level slightly negative from ground, the Vertical Chopped Blanking pulse output level changes to the LO state, and remains LO until the delay ramp goes HI again.

Notice the delay between the leading edge of the clock pulse generated by U4320 and the leading edge of the Vertical Chopped Blanking pulses. The amount of delay between the leading edges of these pulses is determined by the delay ramp applied to pin 10. This delay is necessary due to the delay line in the vertical deflection system. Otherwise, the trace blanking resulting from the Vertical Chopped Blanking pulse would not coincide

TABLE 3-10
Input/Output Combinations for the Vertical Chopped Blanking Stage

| INPUT | | | | | | OUTPUT | |
|------------------------|----------------------------------|-----------------------|-----------------|-----------------------------------|-----------------|---------------------------|---|
| CHOP MODE (VERT) | LEFT PLUG-IN MODE (CHOP INHIBIT) | DISPLAY RIGHT COMMAND | ADD MODE (VERT) | RIGHT PLUG-IN MODE (CHOP INHIBIT) | DELAY RAMP | VERTICAL CHOPPED BLANKING | |
| 3 | 5 | 6 | 7 | 8 | 10 ¹ | 4 ² | CONDITIONS |
| HI | Φ | Φ | LO | Φ | LO | LO | CHOP MODE (VERT) |
| LO | LO | LO | LO | Φ | LO | LO | LEFT PLUG-IN CHOPPED |
| LO | Φ | HI | LO | LO | LO | LO | RIGHT PLUG-IN CHOPPED |
| LO | LO ³ | LO | HI | LO ³ | LO | LO | ADD MODE, LEFT OR RIGHT PLUG-IN CHOPPED |
| ALL OTHER COMBINATIONS | | | | | | HI | NO VERTICAL CHOPPED BLANKING PULSES AT OUTPUT |

Φ = Has no effect in this case.

¹Ramp signal; considered LO when more negative than about zero volts.

²Negative-going pulse at two megahertz rate.

³Pin 5 can be HI and not affect operation if pin 8 is LO, and vice versa.

with the switching between the displayed traces. The duty cycle of the wide pulse train produced in the clock generator stage determines the pulse width of the Vertical Chopped Blanking pulses.

CHOP COUNTER

The Chop Counter stage U4340 produces the Vertical Chopped signal, the Plug-In Chop Command, and the

Horizontal Chopped Blanking signal. The clock pulse produced by the clock generator stage provides the timing signal for the Chop Counter. The functions of the input and output pins for the Chop Counter IC, U4340, are identified in Figure 3-5A. Idealized waveforms showing the timing relationship between the input and output signals for this stage are shown in Figure 3-5B.

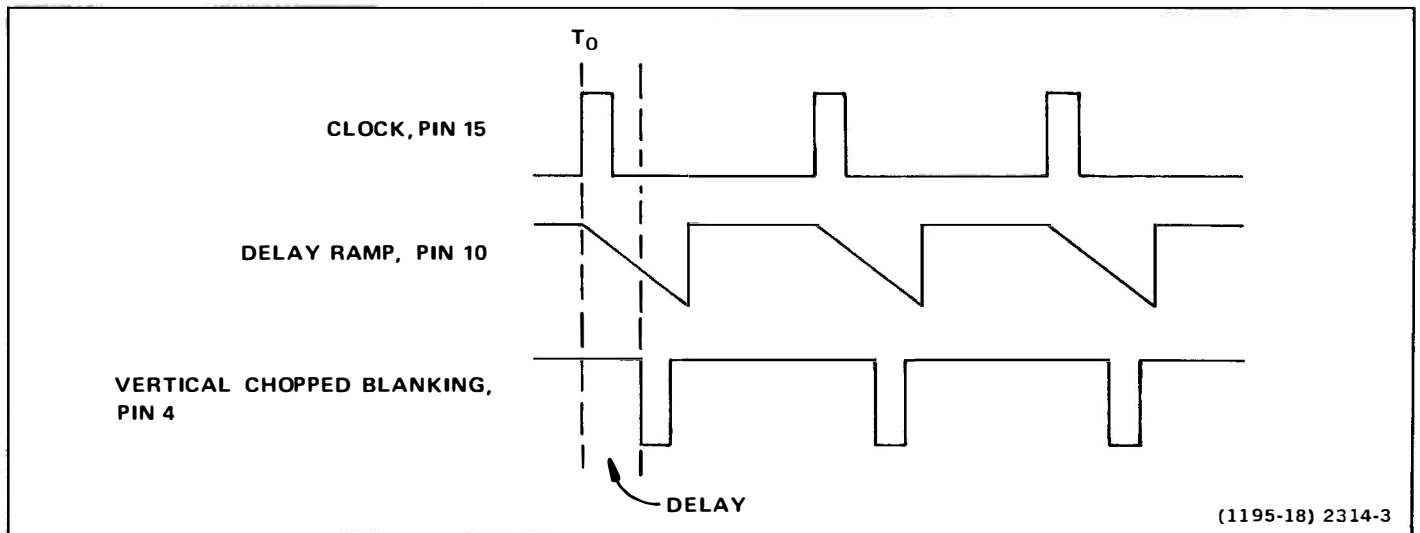

(1195-18) 2314-3

Figure 3-4. Idealized waveforms for the Vertical Chopped Blanking IC (U4320).

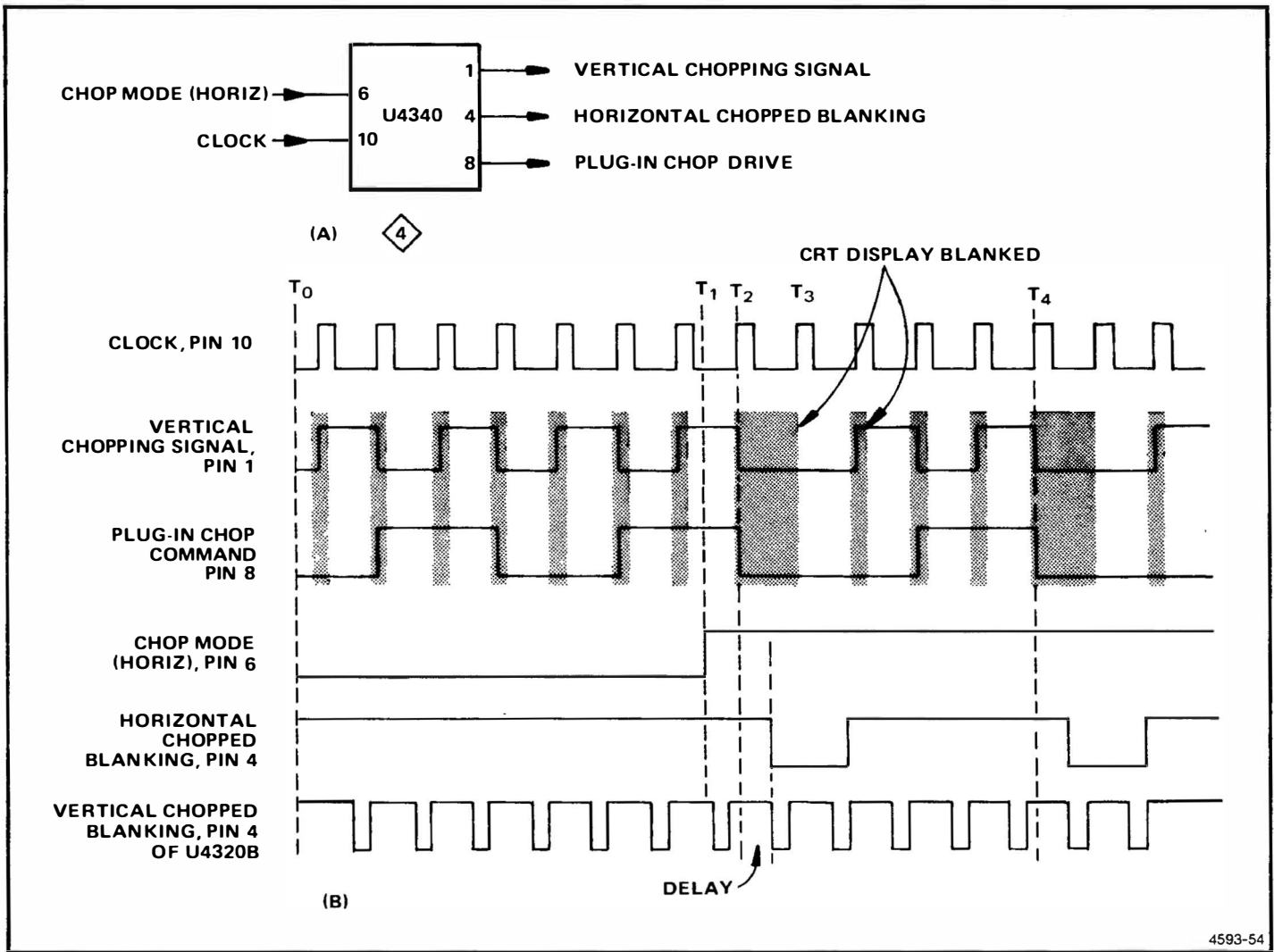

Figure 3-5. (A) Input and output pins for Chop Counter IC, U4340; (B) Idealized waveforms for Chop Counter stage.

The repetition rate of the output signals from this stage is determined by the setting of the HORIZONTAL MODE switch. When the HORIZONTAL MODE switch is set to any position except CHOP, the repetition rate of the Vertical Chopping Signal output at pin 1 is one megahertz (one-half clock rate). This determines the switching between the LEFT and RIGHT VERT units when the VERTICAL MODE switch is set to CHOP. At the same time, the repetition rate of the Plug-In Chop Command at pin 8 is 0.5 megahertz (one-fourth clock rate). This provides a chopping signal that controls switching between channels in dual-trace vertical units. The relationship between these output signals and the clock input is shown by the waveforms in Figure 3-5B in the area between T_0 and T_1 . During this time, the Horizontal Chopped Blanking at pin 4 remains HI.

When the HORIZONTAL MODE switch is set to CHOP, the basic repetition rate of the Vertical Chopping Signal and the Plug-In Chop Command is altered. For example, if the HORIZONTAL MODE switch is changed to the CHOP position at time T_1 (see Fig. 3-5B), a HI level is

applied to pin 6. This stage continues to produce outputs at pins 1 and 8, in the normal manner, until both outputs are at their HI level. (See time T_2 ; this condition only occurs once every fifth clock pulse and only when the HORIZONTAL MODE switch is set to CHOP.) When both of these outputs are at their HI level, the next clock pulse switches both outputs LO, and at the same time switches the Horizontal Chopped Blanking to the LO level.

This change at time T_2 does not appear at pin 4 immediately, due to a delay network in the circuit. The delay is necessary to make the Horizontal Chopped Blanking coincide with the Vertical Chopped Blanking produced by U4320, and the switching between the displayed signals. (Compare bottom two waveforms of Fig. 3-5B; also see Vertical Chopped Blanking for further information.) After the delay time, the output level at pin 4 goes LO where it remains for about 0.5 microsecond which is equal to the period of the clock pulse (two-megahertz repetition rate).

The Horizontal Chopped Blanking time must be longer than the Vertical Chopped Blanking time, since it takes more time for the display to switch between horizontal units than between vertical units. During the time that the level at pin 4 is LO, the crt is blanked, and the Vertical Chopping Signal and the Plug-In Chop Command cannot change levels. The clock pulse at T_3 changes only the Horizontal Chopped Blanking output at pin 4. After the delay time, this pin goes Hi to unblank the crt.

For the next three clock pulses, the Vertical Chopping Signal output and Plug-In Chop Command operate in the normal manner. However, just prior to the fourth clock pulse (time T_4), both outputs are again at their HI level. The fourth clock pulse at T_4 switches the output at pin 1, pin 8, and pin 4 (after delay) to the LO level to start the next cycle. Notice that a Horizontal Chopped Blanking pulse is produced at pin 4 with every fifth clock pulse. Also notice that with the HORIZONTAL MODE switch set to CHOP, two complete cycles of the Vertical Chopping Signal are produced with each five clock pulses (repetition rate two-fifths clock rate) and one complete cycle of the Plug-In Chop Command for every five clock pulses (one-fifth clock rate). Notice that the large shaded area produced by the Horizontal Chopped Blanking pulse (see Fig. 3-5) is not part of the display time (crt display blanked). However, about the same time segment is displayed from the vertical signal source with or without Horizontal Chopped Blanking, due to the change in repetition rate when in the CHOP horizontal mode.

The Vertical Chopping Signal at pin 1 of U4340 is connected to the Vertical Mode Logic stage (see following description) through LR4342. This signal is HI when the RIGHT VERT unit is to be displayed, and it is LO when the LEFT VERT unit is to be displayed. The Plug-In Chop Command at pin 8 is connected to the plug-in units in the vertical compartments through LR4344, via the Main Interface board. When this signal is HI, Channel 2 of the plug-in units can be displayed; when this level is LO, Channel 1 can be displayed. The Horizontal Chopped Blanking signal at pin 4 is connected through LR4338 to the Horizontal Binary stage U4358, and to the Z-Axis Logic stage U4485 by way of Q4336. When this signal is HI, the crt is unblanked to display the selected signal. When it is LO, the crt is blanked to allow switching between the horizontal units.

VERTICAL MODE LOGIC

The Vertical Mode Logic stage is made up of discrete components CR4323-CR4322, CR4369-CR4368 and buffer Q4382-Q4392. These components develop the Display Right Command, which is connected to the Main Interface, Vertical Interface, and Trigger Selector circuits to indicate which vertical unit is to be displayed. When this output level is HI, the RIGHT VERT unit is displayed; when it is LO, the LEFT VERT unit is displayed.

The VERTICAL MODE switch shown on Diagram 2 provides control levels to this stage. This switch provides a HI level on only one of five output lines to indicate the selected vertical mode; the remaining lines are LO. Notice that only four of the lines from the VERTICAL MODE switch are connected to the Logic circuit. Operation of this stage is as follows: When the VERTICAL MODE switch is set to RIGHT, a HI level is connected to the base of Q4382 through R4321. This forward biases Q4382, and the positive-going level at its emitter is connected to the emitter of Q4392. The collector of Q4392 goes HI to indicate that the RIGHT VERT unit is to be displayed. For the CHOP position of the VERTICAL MODE switch, a HI level is applied to the anodes of CR4323-CR4322 through R4322. Both diodes are forward biased so that the Vertical Chopping Signal from pin 1 of U4340 can pass to the base of Q4382. This signal switches between the HI and LO levels at a one-megahertz rate and produces a corresponding Display Right Command output at the collector of Q4392. When the Display Right Command is HI, the RIGHT VERT unit is displayed. When it switches to LO, the LEFT VERT unit is displayed.

In the ALT position of the VERTICAL MODE switch, a HI level is applied to the anodes of CR4369-CR4368 through R4369. These diodes are forward biased so the Vertical Alternate Command from pin 6 of the Vertical Binary stage can pass to the base of Q4382 to determine the Vertical Mode Command level. The Vertical Alternate Command switches between its HI and LO levels at a rate determined by the Vertical Binary stage.

The control levels in the LEFT and ADD positions of the VERTICAL MODE switch are not connected to this stage. However, since only the line corresponding to the selected vertical mode can be HI, the RIGHT, CHOP, and ALT lines must remain at their LO level when either LEFT or ADD are selected. Therefore, the base of Q4382 remains LO to produce a LO Display Right Command signal output level at the collector of Q4392.

A logic diagram of the Vertical Mode Logic stage is shown in Figure 3-6. The discrete components that make up each logic function are identified.

TRACE SEPARATION

The Trace Separation stage is made up of discrete components Q4438, Q4442, Q4448, and Q4456. This stage produces the Trace Separation output to the AUX Y-Axis Input of the Vertical Amplifier circuit, and offsets the B-sweep display when operated in a dual-sweep mode (horizontal). The level of this output current is determined by the setting of the VERT TRACE SEPARATION (B) control. The current from the VERT TRACE SEPARATION (B) control is switched so that the Trace Separation output is provided only when the B sweep is being displayed in the ALT or CHOP horizontal modes, and not when the B sweep only is being displayed, nor during independent-pairs operation (sweep-slaving).

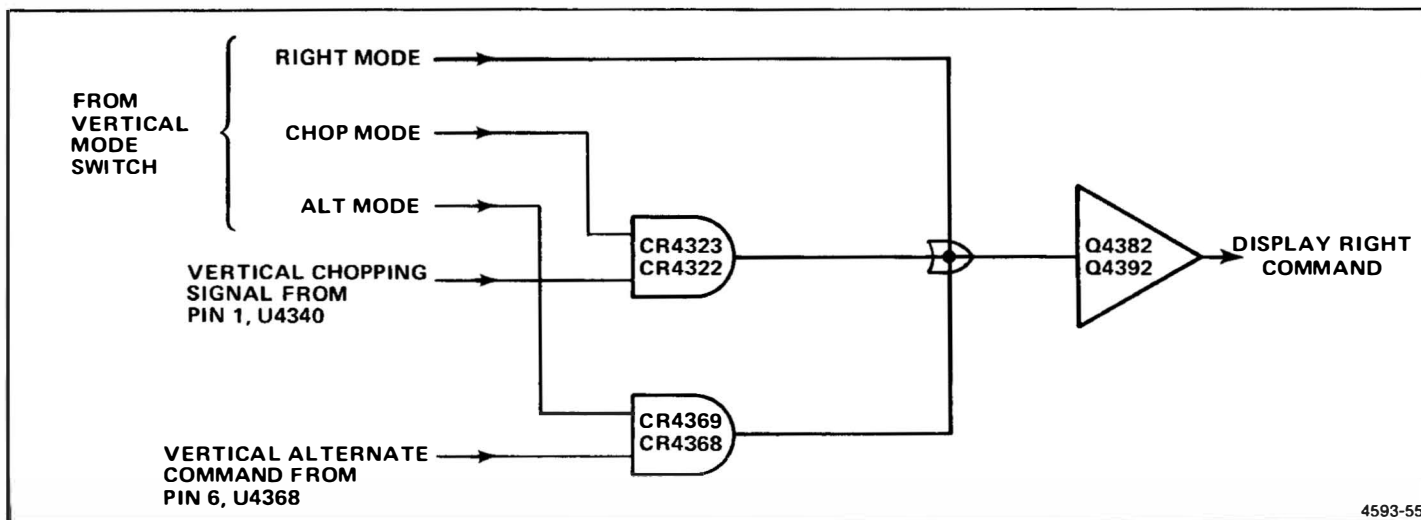

4593-55

Figure 3-6. Logic diagram of Vertical Mode Logic stage.

The VERT TRACE SEPARATION(B) control provides current to the Trace Separation output through R4456 and Q4456 when Q4456 is forward biased. When the B sweep is being displayed (for ALT or CHOP horizontal operation), the Display B Command at the base of Q4442 is HI. This forward biases Q4442 causing its collector to go negative to forward bias Q4448. Then Q4448 saturates, and its collector goes positive to forward bias Q4456. During the time the A sweep is being displayed, the Display B Command is LO. This reverse biases Q4442 and Q4448; Q4456 is reverse biased, so the VERT TRACE SEPARATION (B) control is disconnected while the A-sweep is being displayed.

When the HORIZONTAL MODE switch is set to B (only), a HI level is connected to the emitter of Q4442 through R4431. This reverse biases Q4442, even though the Display B Command at its base is HI for this mode. Therefore, the VERT TRACE SEPARATION (B) control has no effect. When the VERTICAL MODE switch is set to ALT and the Delay Mode Control level from the A time-base unit is LO (indicating nondelayed sweep operation), a HI level is applied to the emitter of Q4442 through R4438 and CR4434. This HI level reverse biases Q4442, even though the Display B Command is HI. This action disconnects the VERT TRACE SEPARATION (B) control for independent-pairs operation so that the vertical position of the B-sweep display is determined by the slaved LEFT VERT plug-in unit only. If delayed-sweep operation is selected, the Delay Mode Control Out level is HI, forward biasing Q4438 and Q4443. This allows the VERT TRACE SEPARATION (B) control to position the B-sweep display, since independent-pairs operation is not possible when operating in a delayed-sweep mode.

A logic diagram of the Trace Separation stage is shown in Figure 3-7A. The discrete components which make up each logic function are identified. An input/output table for this stage is given in Figure 3-7B.

SWEEP CONTROLLED Z-AXIS X-Y

X-Y displays can only be obtained in conjunction with a time-base unit. When an amplifier unit is installed in the A (B) Horizontal Compartment, the Z-Axis is controlled by the time-base unit in the B (A) horizontal compartment, independent of the setting of the HORIZONTAL MODE switch. The B (A) indicator lamp automatically turns on; the selection of the horizontal mode by the HORIZONTAL MODE switch is not effected. X-Y displays often consist of a display where a fast switching transient occurs between two stable states. The switching may be such that the display is predominantly in these two stable states. If the Z-Axis was not duty cycled, but turned on permanently this would result in a display with two bright spots and a barely-visible or invisible transient, since the average screen current associated with these bright spots can be large enough to enable the intensity limiter.

By triggering the time-base unit with the Y-Axis signal, the duty cycle of the Z-Axis can be controlled with the time-base unit time/division control. With the HORIZONTAL MODE switch set to ALT an X-Y display alternating with a Y-T display is obtained. The Z-Axis for both displays is on only during the waveform segment shown in the Y-T display. This is a visible aid for optimum control of the Z-Axis duty cycle of X-Y displays. A slide switch located on the Logic board selects how the Z-Axis is controlled during X-Y displays. Normally the switch is in the IN position so that the Z-Axis is controlled by a time-base unit. In the OUT position, the HORIZONTAL MODE switch controls the Z-Axis.

Without a vertical plug-in unit in a horizontal compartment, diodes CR4487 and CR4495 do not conduct. Q4488 acts as an emitter follower. Resistors R4486 and R4487 perform a dc level shift approximately equal to the emitter-base drop of Q4488. Q4492 is

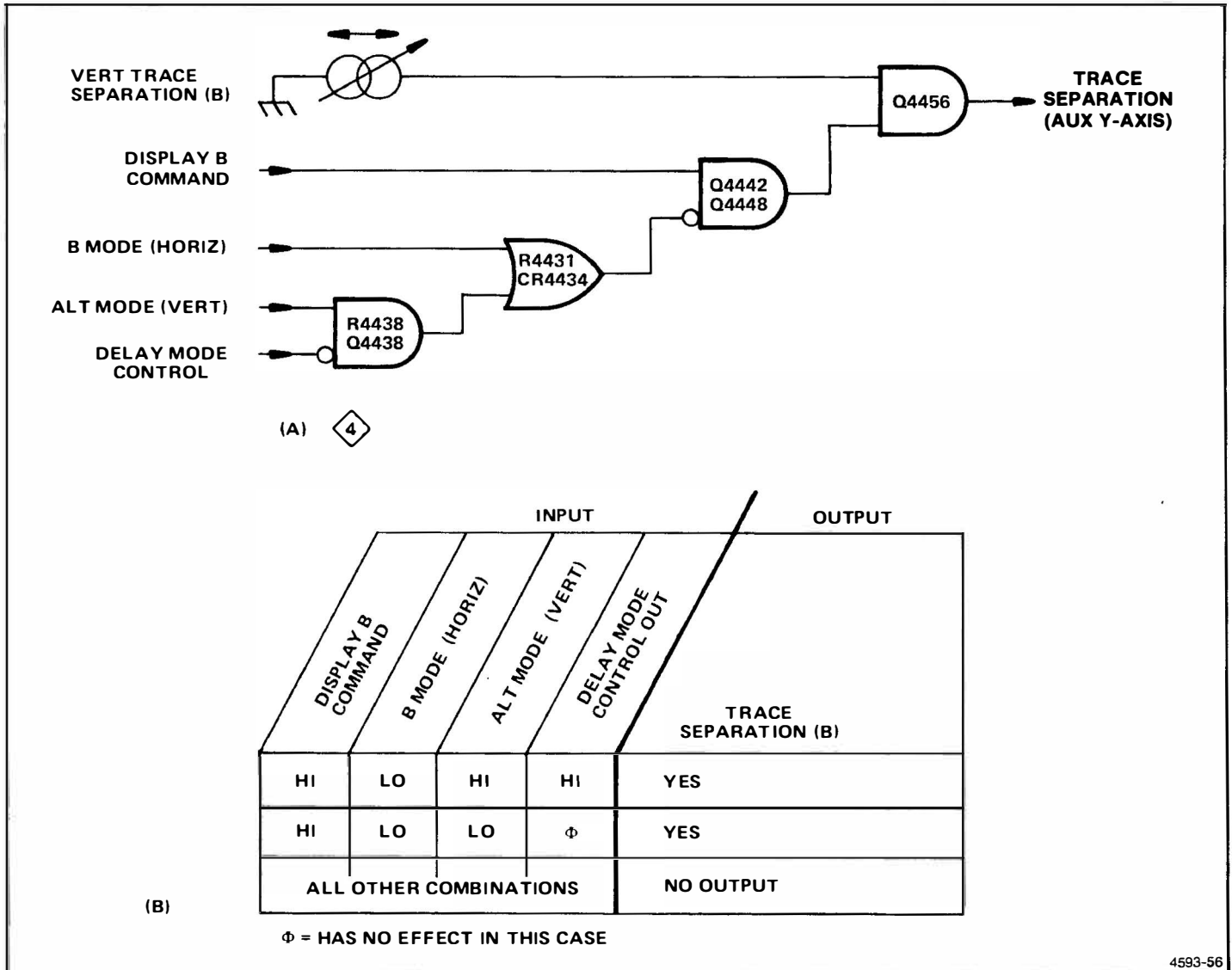

Figure 3-7. (A) Logic diagram of Trace Separation stage; (B) Table of input/output combinations.

turned off, so the voltage at the collector of Q4492 is a duplicate of the Display B Command. If diode CR4487 is connected to ground by an amplifier unit in the B Horizontal compartment, the Display B Command is not applied to the base of Q4488, and the signal at the collector of Q4492 is LO. In this condition, the Z-Axis logic IC selects the A INTENSITY input only, independent of other control inputs. If diode CR4495 is connected to ground by an amplifier unit installed in the A Horizontal compartment, Q4492 is saturated. The emitter of Q4488 is held at a HI level, so even when the display B Command is HI, Q4488 does not conduct. The Z-Axis logic IC selects the B Intensity input when the signal at the collector of Q4492 is HI, regardless of other control inputs.

Transistors Q4494 and Q4498 drive the A and B INTENSITY indicator lights. With an amplifier unit installed in either A or B Horizontal compartments,

diode CR4496 or CR4493 conducts. This prevents Q4494 and Q4498 from turning on when the HORIZONTAL MODE switch is set to ALT or CHOP.

With an amplifier unit installed in the A Horizontal compartment, the signal at the collector of Q4492 is HI. This turns on Q4494 and the B INTENSITY indicator lamp, which indicates that the Z-Axis is controlled by the time-base unit installed in the B Horizontal compartment. The signal at the collector of Q4492A is LO when an amplifier is installed in the B Horizontal compartment. Now, Q4498 is saturated. Base current flows from the +5 V lamp supply, through the B indicator lamp and the resistor R4493, to the base of Q4498. This base current is not sufficient to light the B INTENSITY indicator lamp, so the A INTENSITY indicator lamp is turned on. This indicates that the Z-Axis is controlled by the time-base unit in the A Horizontal compartment.

Theory of Operation—7904A

When time-base units are installed in both A and B Horizontal compartments Q4494 and Q4498 are saturated (with the HORIZONTAL MODE switch in ALT or CHOP). Base current is provided from the +5 V supply on the mode switch board, through either the ALT or CHOP switch contacts, and through resistors R4486 and R4490, to the bases of Q4494 and R4498. Both A and B INTENSITY indicator lights are on.

When the HORIZONTAL MODE switch is set to A or B, the voltage at the collector of Q4492 (which is derived from the Display B Command signal) controls the A and B INTENSITY lights as previously described.



TRIGGER SELECTOR

The Trigger Selector circuit determines the source of the internal triggering signals connected to the A and B Horizontal compartments. A schematic diagram of the Trigger Selector is given on Diagram 5, in Section 8 of this manual (Diagram and Circuit Board Illustrations). The schematic is divided by gray shaded lines separating the circuitry into major stages. These stages aid in locating components mentioned here. Sub-headings in the following discussion use these stage names to further identify portions of the circuitry on Diagram 5.

A AND B TRIGGER CHANNEL SWITCHES

The operation of the A and B Trigger Channel Switch stages is similar. Therefore, only a discussion of the A Trigger Channel Switch is given.

Amplifier units installed in the vertical compartments provide a differential trigger signal to the mainframe. These signals are terminated into 50 ohm power dividers. The 50-ohm strip transmission lines carry half of the input signal from the power dividers to the A and B Trigger Selector circuits. The inputs of the channel switches, U232 and U432, have a 50 ohm input impedance, and terminate the transmission lines.

A Trigger Channel Switch

Channel switch U232 has two differential inputs and one differential output. Control voltages at pins 1, 2, 11 and 12 determine whether the input signals are terminated within the channel switch or are coupled through to the output. Active components U252A and Q254 keep the output dc common mode voltage on pin 3 and pin 13 at +3.2 volts for all modes of the channel switch, U232. The dc common voltage is sensed by resistors R237 and R247 and is compared with a +3.2 volt reference set by divider R251 and R252. If resistors R237 and R247 sense a voltage higher than +3.2 volts, the output of U252A goes negative, lowering the base voltage on Q254. This

reduces the current into pin 13A, which causes the dc common mode voltage at pin 3 and 13 to decrease. The voltage at pin 13A depends on the channel switch mode. When the VERTICAL MODE switch is set to LEFT, RIGHT, or ALT the voltage on pin 13A, is +3.8 volts. When the VERTICAL MODE switch is set to ADD the voltage on pin 13A is +4.6 volts.

Each channel within U232 has an independent pair of control pins for channel selection. If the "On" pin is more positive than the "Off" pin that channel is selected. All of the "On" pins are held at +2.0 volts. The "Off" pins are either at +2.5 volts or at a T²L LO level. The A Trigger Channel Switch has four operating modes: Left, Right, Alt, and Add. In the Left and Right modes, the Add logic level is HI (on pin CF); the Right Logic Level (on pin CG) is LO for Left and is HI for Right. In the ALT mode, Add is HI, and Right alternates between LO and HI. In the ADD Mode, both Add and Right are LO. (See the discussion on Mode Switching, in this section of the Manual.)

Zener diodes VR237 and VR247 shift the dc level downward by 9 volts, to set the output of U274 near ground. Diodes VR237 and VR247 are voltage-matched to within 100 mV.

A AND B TRIGGER AMPLIFIER

The operation of the A and B Trigger Amplifiers is similar. Therefore, only a discussion of the A Trigger Amplifier is given. Integrated Circuit U274 provides final amplification of the trigger signal. Components R261 and R272 are bias resistors for U274. Zener diodes VR237 and VR247 have a 5% voltage tolerance, therefore the dc voltage level at pins 7 and 9 of U274 is -5.8 volt within 0.45 volt. The dc common-mode voltage, with its 0.45 volt uncertainty, is picked off at pin 8 and pin 12 of U274 and applied to the noninverting input of U252B. The output of U252B is 1.2 volts more positive than the input and is used for internal biasing at pin 15 of U274. Resistor R274 determines the gain of U274. The overall voltage gain of the A trigger selector from the input connectors J202, J203 and J402, J403 to the output J270, J271, into a load of 50 ohm per side, is one. The dc output level of U274 is zero volts; R235 sets the dc Centering and R279 adjust the DC Common Mode voltage.

Thermal compensation for U232 and U274 is provided by four time constants: R240 and C240, C237, R250 and C250, R270, and C270.

The operation of the B trigger selector is similar except for the signal pickoff of pin 2 and pin 4 of U474, which is used to generate the Vertical Signal Out.

VERTICAL SIGNAL OUTPUT AMPLIFIER

A differential signal is picked off at pin 2 and pin 4 of U474 and is amplified by U492. Before the signal

reaches the input of U492, it passes through a compensation circuit consisting of C483, R483, R486, L486, R496, C492 and R493. The characteristic impedance of this circuit is 100 ohms differentially, and terminates the 50 ohm strip transmission lines running from the pickoff points at pin 2 and pin 4 of U474. At pin 2 and pin 4, there is an uncertainty in the dc common-mode level due to the 5% voltage tolerance of zener diodes VR437 and VR447. Integrated circuit U452B passes on this uncertainty for biasing U492. The output signal at J496 is centered at 0 volt by R485. The signal out amplitude is 25 millivolts/division of vertical deflection into a load of 50 ohms, and 0.5 volt/division of vertical deflection into a 1 megohm load. Two time constants, R480 and L480, and R490 and C490, provide thermal compensation.



READOUT SYSTEM (SN B031766 & Below)

A schematic diagram of the Readout System is given on Diagram 6, in Section 8 of this manual (Diagrams and Circuit Board Illustrations). This schematic is divided by gray shaded lines separating the circuitry into major stages. These stages aid in locating components mentioned here. Stage name headings in the following discussion are used to further identify portions of the circuitry on Diagram 6.

The Readout System provides an alphanumeric display of information encoded by the plug-in units. This display is presented on the crt and is written by the crt beam on a time-shared basis with the analog waveform display.

The following terms are used to describe the Readout System:

Character—A single number, letter or symbol displayed on the crt, either alone or in combination with other characters.

Word—A group of related characters. In the Readout System, a word can consist of up to 10 characters.

Frame—A display of all words for a given operating mode and plug-in combination. Up to 8 words can be displayed in one frame. Figure 3-8 shows the position of each word in a complete frame.

Column—One of the vertical lines in the Character Selection Matrix (see Fig. 3-9). Columns C-0 (column zero) through C-10 (column 10) can be addressed by the system.

Row—One of the horizontal lines in the Character Selection matrix. Rows R-1 (row 1) through R-10 (row 10) and R-14 (row 14) can be addressed by the system.

Time-Slot—A location in a pulse train. In the Readout System, the pulse train consists of 10 negative-going pulses. Each time-slot pulse is assigned a number between 1 and 10. For example, the first time-slot is TS-1.

Time-Multiplexing—Transmission of data from two or more sources over a common path by using different time intervals for different signals.

DISPLAY FORMAT

Up to 8 words of readout information can be displayed on the crt. The position of each word is fixed and is directly related to the plug-in unit from which it originated. Figure 3-8 shows the area of the graticule where the readout from each plug-in unit is displayed. Notice that Channel 1 of each plug-in unit is displayed within the top division of the crt, and Channel 2 is displayed directly below within the bottom division. Figure 3-10 shows a typical display where only Channel 2 of the Right Vertical and B Horizontal units is selected for display.

Each word in the readout display can contain up to 10 characters, although the typical display will contain between 2 and 7 characters per word. The characters are selected from the Character Selection Matrix shown in Figure 3-9. In addition, 12 operational addresses are

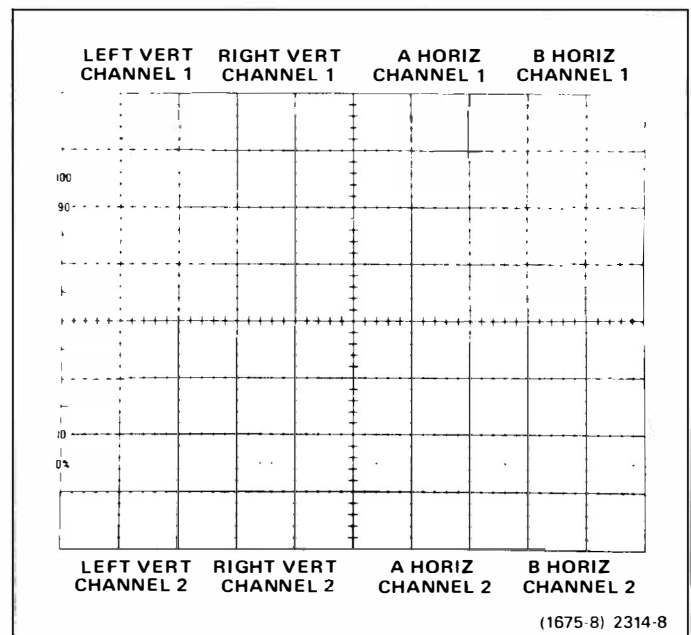
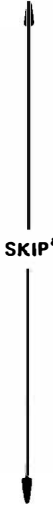

Figure 3-8. Location of readout display on the crt identifying the originating plug-in and channel.

| COLUMN NUMBER | | C-0 | C-1 | C-2 | C-3 | C-4 | C-5 | C-6 | C-7 | C-8 | C-9 | C-10 | |
|---------------|-------------------------|--|--|----------------------------------|--|--|--|--|--|-----|-------------------------------|-------|-----------------------|
| ROW NUMBER | CURRENT (MILLI-AMPERES) | 0 | 0.1 | 0.2 | 0.3 | 0.4 | 0.5 | 0.6 | 0.7 | 0.8 | 0.9 | ≥ 1.0 | |
| R-1 | 0 | SKIP ^a  | 0 | 1 | 2 | 3 | 4 | 5 | 6 | 7 | 8 | 9 | |
| R-2 | 0.1 | | / | < | I | / | + | - | + | C | Δ | > | |
| R-3 | 0.2 | | ADD ^a ONE ZERO | ADD ^a TWO ZEROS | SHIFT ^a PREFIX ← | SHIFT ^a PREFIX ← AND ADD ONE ZERO | | | | | | | IDENTIFY ^a |
| R-4 | 0.3 | | m | μ | n | p | X | K | M | G | T | R | |
| R-5 | 0.4 | | S | V | A | W | H | d | B | c | Ω | E | |
| R-6 | 0.5 | | U | N | L | Z | Y | P | F | J | Q | D | |
| R-7 | 0.6 | | | | DECIMAL ^a POINT LOCATION NO. 3 | DECIMAL ^a POINT LOCATION NO. 4 | DECIMAL ^a POINT LOCATION NO. 5 | DECIMAL ^a POINT LOCATION NO. 6 | DECIMAL ^a POINT LOCATION NO. 7 | | | | |
| R-8 | 0.7 | | | | | | | | | | DECIMAL ^b POINT | | |
| R-9 | 0.8 | | | | | | | | | | | | |
| R-10 | 0.9 | | ADD SPACE IN DISPLAY ^a | | | | | | | | | | |



UNUSED LOCATIONS. AVAILABLE FOR FUTURE EXPANSION OF READOUT SYSTEM

^aOPERATIONAL ADDRESS.

^bDECIMAL POINT CHARACTER. SEE DECIMAL POINT CHARACTER DESCRIPTION IN TEXT.

Figure 3-9. Character selection matrix for 7904A Readout System (SN B031766 & Below).

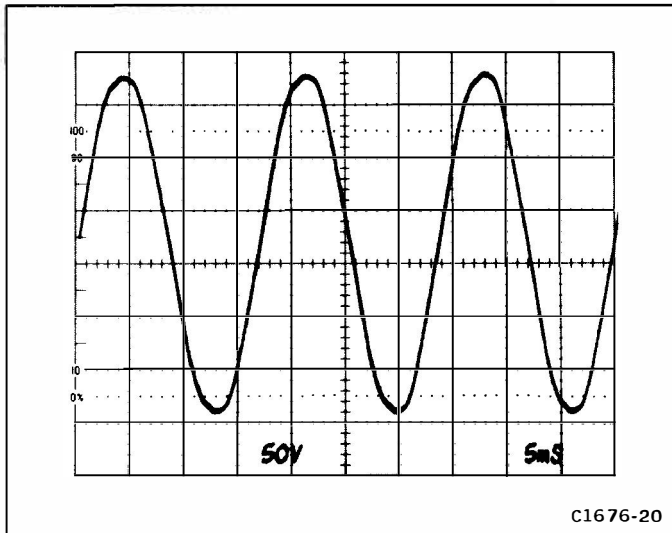

Figure 3-10. Typical readout display where only channel 2 (of the Right Vertical and B Horizontal units) is displayed.

provided for special instructions to the Readout System. The unused locations in the Matrix (shaded area) are available for future expansion of the Readout System. The method of addressing the locations in the Character Selection Matrix is described in the following discussion.

DEVELOPING THE DISPLAY

This description is intended to relate the basic function of each stage to the operation of the overall Readout System. Detailed information on circuit operation is given later.

The key block in the Readout System is the Timer Stage (see schematic 6). This stage produces the basic signals that establish the timing sequences within the Readout System. The period of the timing signal is about 250 microseconds (it drops to about 210 microseconds when Display-Skip is received; see detailed description of Timer stage for further information). This stage also produces control signals for other stages within this circuit, and inhibit signals to the Vertical Amplifier, Horizontal Amplifier, and Logic circuits, which allow a readout display to be presented. The Time-Slot Counter stage receives a trapezoidal voltage signal from the Timer stage and directs it to one of ten output lines. These output lines are labeled TS-1 through TS-10 (time-slots 1 through 10) and are connected to the vertical and horizontal plug-in compartments as well as to various stages within the Readout System. The output lines are energized sequentially, so there is a pulse on only one of the 10 lines during any 250-microsecond timing period. After the Time-Slot Counter stage has counted time-slot 10, it produces an End-of-Word pulse which advances the system to the next channel.

Two output lines (row and column) are connected from each channel of the plug-in unit back to the Readout System. Data is typically encoded on these output lines by connecting resistors between them and the time-slot input lines. The resultant output is a sequence of 10 analog current levels that range from 0 to 1 milliamperere (100 microamperes/step) on the row and column output lines. This row and column corresponds to the row and column of the Character Selection Matrix in Figure 3-9. The standard format for encoding information onto the output lines is given in Table 3-11. (Special-purpose plug-in units may have their own format for readout; these special formats will be defined in the manuals for these units.)

TABLE 3-11
Standard Readout Format

| Time-Slot Number | Description |
|----------------------|--|
| TS-1 | Determines Decimal Magnitude (number of zeros displayed or prefix change information) or the IDENTIFY function (no display during this time-slot). |
| TS-2 | Indicates normal or inverted input (no display for normal). |
| TS-3 | Indicates calibrated or uncalibrated condition of plug-in variable control (no display for calibrated condition). |
| TS-4 | Scaling. |
| TS-5 TS-6 TS-7 | Not encoded by plug-in unit. Left blank to allow addition of zeros by Readout System. |
| TS-8 | Defines the prefix which modifies the units of measurement. |
| TS-9 TS-10 | Defines the units of measurement of the plug-in unit. May be standard unit of measurement (V, A, S, etc.) or special units selected from the Character Selection Matrix. |

The encoded column and row data from the plug-in units is selected by the Column Data Switch and Row Data Switch stages respectively. These stages take the analog current from the 8 data lines (2 channels from each of the 4 plug-in compartments) and produce a time-multiplexed analog voltage output containing all of the column and row information from the plug-ins. The Column Data Switch and Row Data Switch are sequenced by the binary Channel Address Code from the Channel Counter.

The time-multiplexed output of the Column Data Switch is monitored by the Display-Skip Generator to determine if it represents valid information that should

Theory of Operation—7904A

be displayed. Whenever information is not encoded in a time-slot, the Display-Skip Generator produces an output level to prevent the Timer stage from producing the control signals that normally interrupt the crt display and present a character.

The analog outputs of the Column Data Switch and Row Data Switch are connected to the Column Decoder and Row Decoder stages respectively. These stages sense the magnitude of the analog voltage input and produce an output current on one of ten lines. The outputs of the Column Decoder stage are identified as C-1 through C-10 (column 1 through 10) corresponding to the encoded column information. Likewise, the outputs of the Row Decoder stage are identified as R-1 through R-10 (row 1 through 10) corresponding to the encoded row information. The primary function of the row and column outputs is to select a character from the Character Selection Matrix to be produced by the Character Generator stage. These outputs are also used at other points within the system to indicate when certain information has been encoded. One such stage is the Zeros Logic and Memory. During time-slot 1 (TS-1), this stage checks if zero-adding or prefix-shifting information has been encoded by the plug-in unit, and stores it in the memory until time-slots 5, 6, or 8. After storing this information, it triggers the Display-Skip Generator stage so that there is no display during time-slot 1 (as defined by Standard Readout Format; see Table 3-11). When time-slots 5, 6, and 8 occur, the memory is addressed and any information stored there during time-slot 1 is transferred to the input of the Column Decoder stage to modify the analog data during the applicable time-slot.

Also, the Zeros Logic and Memory stage produces the IDENTIFY function. When time-slot 1 is encoded for IDENTIFY (column 10, row 3), this stage produces an output level, which connects the Column Data Switch and Row Data Switch to a coding network within the Readout System. Then, during time-slots 2 through 9, an analog current output is produced from the Column Data Switch and Row Data Switch, which addresses the correct points in the Character Selection Matrix to display the word "IDENTIFY" on the crt. The Zeros Logic and Memory stage is reset after each word by the Word Trigger pulse.

The Character Generator stages produce the characters which are displayed on the crt. Any of the 50 characters shown on the Character Selection Matrix of Figure 3-9 can be addressed by proper selection of the column and row currents. Only one character is addressable in any one time-slot; a space can be added into the displayed word by the Decimal Point Logic and Character Position Counter stage when encoded by the plug-in. The latter stage counts the number of characters generated and produces an output current to step the display one character position to the right for each character. In addition, the character position is advanced once during

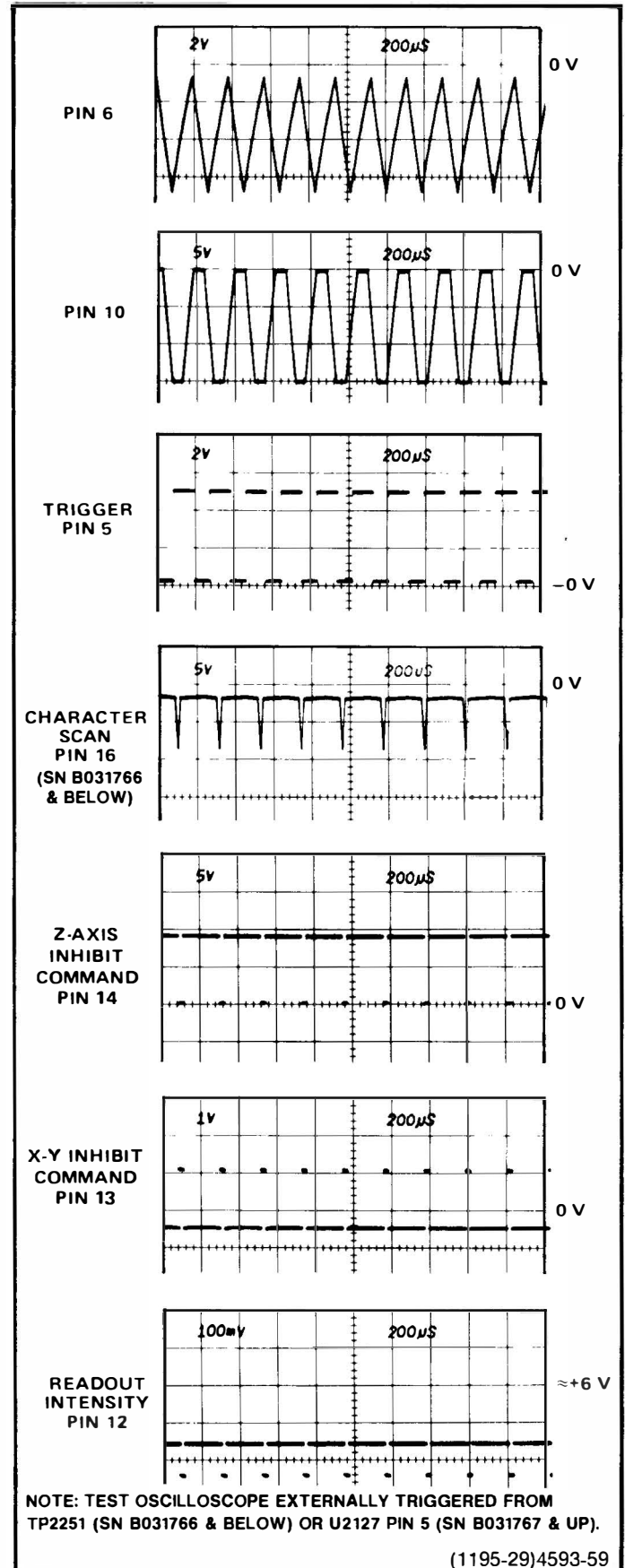

Figure 3-11. Output waveforms of the Timer stage.

each of time-slots 1, 2, and 3, whether a character is generated during these time-slots or not. This action fixes the starting point of the standard-format display such that the first digit of the scaling factor always starts at the same point within each word regardless of the information encoded in time-slot 1, 2, or 3 preceding this digit. Also, by encoding row 10 and column 0 during any time-slot, a blank space can be added to the display. Decimal points can be added to the display at any time by addressing the appropriate row and column. (See Character Selection Matrix for location of decimal points.) The Decimal Point Logic and Character Position Counter stage is reset after each word by the Word Trigger pulse.

The Format Generator stage provides the output signals to the vertical and horizontal deflection systems of the instrument to produce the character display. The binary Channel Address Code from the Channel Counter stage is connected to this stage, so that the display from each channel is positioned to the area of the crt associated with the plug-in and channel originating the word (see Fig. 3-8). The positioning current or decimal point location current generated by the Decimal Point Logic and Character Position Counter stage is added to the Horizontal (X) signal at the input to the Format Generator stage to provide horizontal positioning of the characters within each word. The X- and Y-Readout signals are connected to the Horizontal Amplifier and Vertical Amplifier through the X- and Y-Buffer stages.

The Word Trigger stage produces a trigger from the End-of-Word pulse generated by the Time-Slot Counter stage after the tenth time-slot. This Word Trigger pulse advances the Channel Counter to display the information from the next channel or plug-in. It also provides a reset pulse to the Zeros Logic and Memory stage and the Decimal Point Logic and Character Position Counter stage. This Word Trigger stage can also be advanced to jump a complete word, or a portion of a word, when a Jump Command is received from the Row Data Switch stage.

TIMER

The Timer stage establishes the timing sequence for all circuits within the Readout System. This stage produces 7 time-related output waveforms (see Fig. 3-11). The triangle waveform produced at pin 6 forms the basis for the remaining signals. The basic period of this triangle waveform is about 250 microseconds, as controlled by RC network R2135 and C2135. The triangle waveform is clipped and amplified by U2126 to form the trapezoidal output signal at pin 10. The amplitude of this output signal is exactly 15 volts, as determined by U2126 (exact amplitude is necessary to accurately encode data in plug-in units; see Encoding the Data). The trigger output at pin 5 provides the switching signal for the Time-Slot Counter and Word Trigger stages.

The signals at pins 12, 13, 14, and 16 are produced only when the triangle waveform is on its negative slope and the trapezoidal waveform has reached the lower level. The timing sequence of these waveforms is important to the operation of the Readout System (see expanded waveforms in Fig. 3-12). The Z-Axis Inhibit command at pin 14 is produced first. This negative-going signal provides a blanking pulse to the Z-Axis Logic stage (see Diagram 4) to blank the crt before the display is switched to the Readout System. It also produces the strobe pulse through Q2138 and CR2142 to signal other stages within the Readout System to begin the sequence necessary to produce a character. The collector level of Q2138 is also connected to Symbol Character Generator, U2272 by way of CR2140. This activates U2272 during the quiescent period of the strobe pulse (collector of Q2138 negative) and diverts the output current of Row Decoder U2185 to row 2. The purpose of this configuration is to prevent the Zeros Logic and Memory stage U2232 from storing incorrect data during the quiescent period of the strobe pulse. When the strobe pulse goes positive, CR2140 is reverse biased to

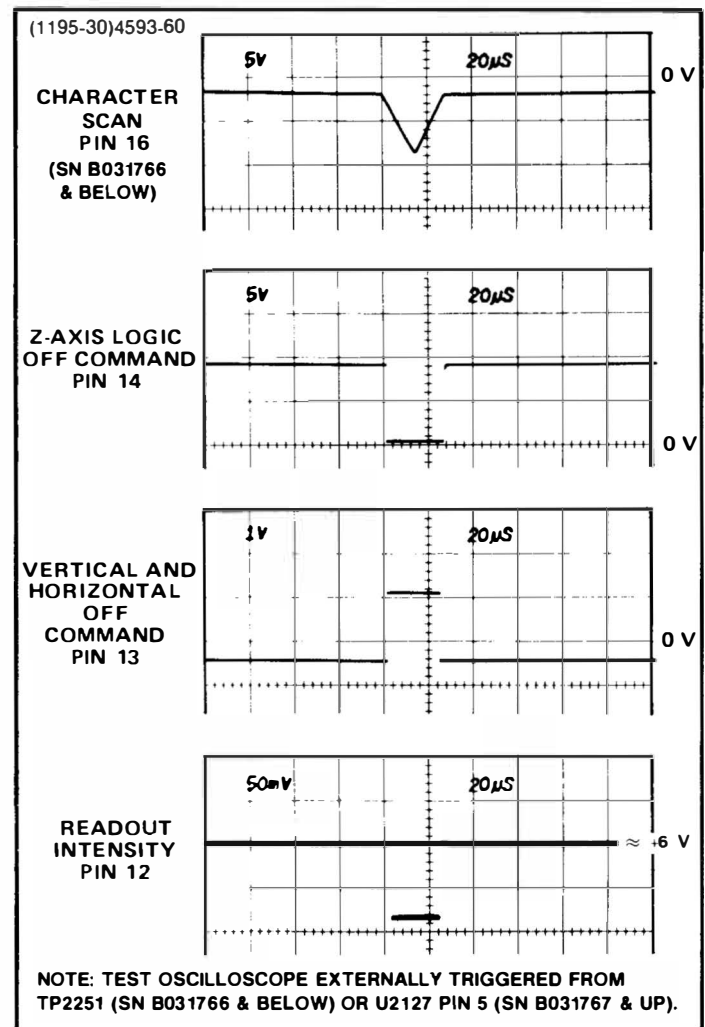

Figure 3-12. Detail of output at pins 12, 13, 14 and 16 of U2126.

Theory of Operation—7904A

disconnect Q2138 from U2272 and allow the Row Decoder to operate in the normal manner.

The next signal to be produced is the X-Y Inhibit Command at pin 13. This positive-going signal disconnects the plug-in signals from the vertical and horizontal deflection systems. The Ready signal derived from this output is connected to the Decimal Point Logic and Character Position Counter stage and the Format Generator stage.

The Z Readout output at pin 12 is produced next. This current is connected to the crt circuit to unblank the crt to the intensity level determined by the voltage on the Gate Readout Intensity line. The Character Scan ramp at pin 16 started to go negative as this timing sequence began. However, character generation does not start until the readout intensity level has been established. The triangular Character Scan ramp runs from about -2 volts to about -8.5 volts, then returns back to the original level. This waveform provides the scanning signal for the Character Generator stages. Character Scan adjustment, R2128, sets the dc level of the Character Scan ramp for complete characters on the display.

The Timer stage operates in one of two modes as controlled by the Display-Skip level at pin 4. The basic mode just described is a condition that does not occur unless all ten characters of each word (80 characters total) are displayed on the crt. Under typical conditions, only a few characters are displayed in each word. The Display-Skip level at pin 4 determines the period of the Timer output signal. When a character is to be generated, pin 4 is LO and the circuit operates as just described. However, when a character is not to be displayed, a HI level is applied to pin 4 of U2126 through CR2125 from the Display-Skip Generator stage. This signal causes the Timer to shorten its period of operation to about 210 microseconds. The waveforms in Figure 3-13 show the operation of the Timer stage when the Display-Skip condition occurs for all positions in a word. Notice that there is no output at pins 12, 13, 14, and 16 under this condition. This means that the crt display is not interrupted to display characters. Also notice that the triangle waveform at pin 6 does not go as far negative, and that the negative portion of the trapezoidal waveform at pin 10 is shorter. Complete details on operation of the Display-Skip Generator are given later.

The Timer operation is also controlled by the Single-Shot Lockout level at pin 2. If this level is LO, the Timer operates as just described. However, if the Single-Shot Lockout stage sets a HI level at this pin, the Timer stage is locked out and can not produce any output signals (see Single-Shot Lockout description for further information).

A negative voltage on the readout Intensity line sets the intensity of the readout display independently of the A

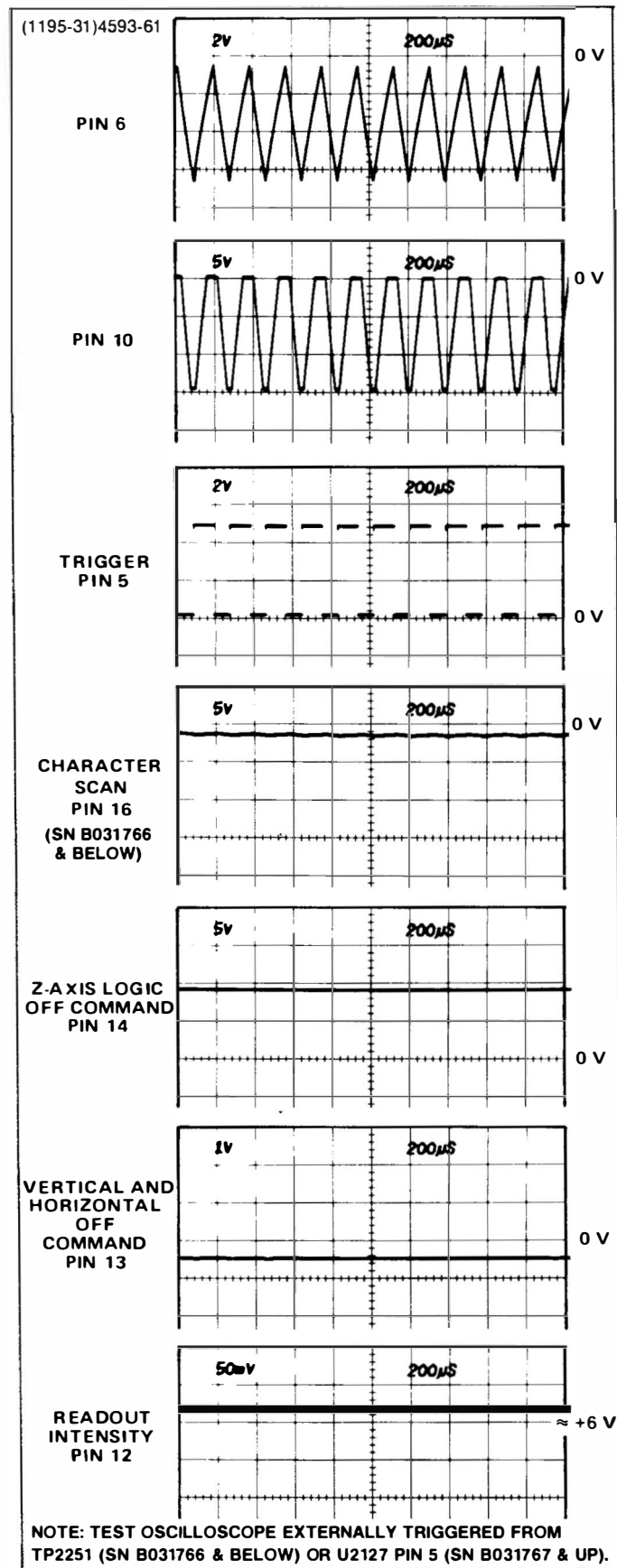

Figure 3-13. Timer stage operation when display-skip condition occurs.

or B INTENSITY controls. The Readout Intensity line also provides a means of turning the Readout System off when a readout display is not desired. When the Readout Intensity line is left open, the current from pin 11 of U2126 is interrupted, and at the same time, a positive voltage is applied to pin 4 through CR2124. The positive voltage switches the stage to the same conditions as were present under the Display-Skip condition. Therefore, the crt display is not interrupted to present characters. However, time-slot pulses continue to be generated.

TIME-SLOT COUNTER

Time-Slot Counter U2159 is a sequential switch which directs the trapezoidal waveform input at pin 8 to one of its 10 output lines. These time-slot pulses are used to interrogate the plug-in units to obtain data for the Readout System. The trigger pulse at pin 15 switches the Time-Slot Counter to the next output line; the output signal is sequenced consecutively from time-slot 1 through time-slot 10. Figure 3-14 shows the time relationship of the time-slot pulses. Notice that only one line carries a time-slot pulse at any given time. When time-slot 10 is completed, a negative-going end-of-word pulse is produced at pin 2. The end-of-word pulse provides a drive pulse for the Word Trigger stage and also provides an enabling level to the Display-Skip Generator during time-slot 1 only.

Pin 16 is a reset input for the Time-Slot Counter. When this pin is held LO, the Time-Slot Counter resets to time-slot 1. The Time-Slot Counter can be reset in this manner only when a Jump-Command is received by U2155C and D (see following discussion).

WORD TRIGGER

The Word Trigger stage is made up of U2155A and B. Quiescently, pin 3 of U2155A is LO as established by the operating conditions of U2155D and C. Therefore, the LO end-of-word pulse produced by the Time-Slot Counter results in a HI level at pin 1 of U2155A. This level, inverted by U2155B, provides a negative-going Word Trigger pulse to the Channel Counter.

Also, a Word Trigger pulse is produced by U2155B when a Jump Command is received at pin 8 of U2155C. This condition can occur during any time-slot (see Row Decoder for further information on origin of the Jump Command). Integrated circuit U2155D and C are connected as a bistable flip-flop. The positive-going Jump Command at pin 8 of U2155C produces a LO at pin 10. This LO is inverted by U2155D to produce a HI at pin 13, which allows pin 9 to be pulled HI through CR2156. The flip-flop has now been set and remains in this condition until reset, even though the Jump Command at pin 8 returns to its LO level. The HI output level at pin 13 turns on Q2159 to pull pin 16 of the Time-

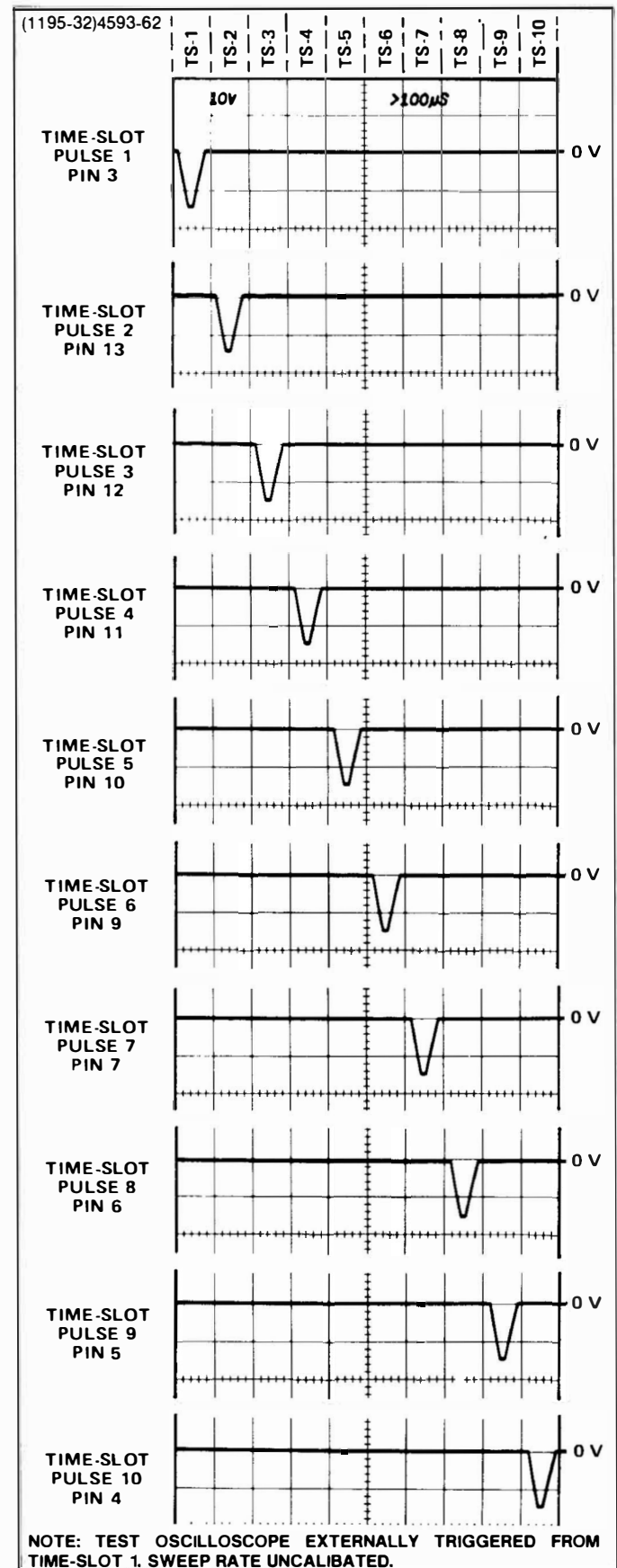

Figure 3-14. Timer relationship of the time-slot (TS) pulses produced by U2159.

Theory of Operation—7904A

Slot Counter LO. This resets the Time-Slot Counter to time-slot 1 and holds it there until the Word Trigger is reset. At the same time, a HI level is applied to pin 4 of the Timer through CR2157 and CR2125. This HI level causes the Timer to operate in the Display-Skip mode, so a character is not generated.

The next Trigger pulse is not recognized by the Time-Slot Counter, since U2159 is locked in time-slot 1 by U2155. However, this Trigger pulse resets the Word Trigger stage through C2155. Pin 13 of U2155D goes LO to enable the Time-Slot Counter and Timer stages for the next time-slot pulse. Simultaneously, when U2155D switches output states, the resulting negative-going edge is connected to pin 3 of U2155A. This results in a negative-going Word Trigger output at pin 4 of U2155B to advance the Channel Counter to the next word. When the next Trigger pulse is received at pin 15 of U2159 the Time-Slot Counter returns to the normal sequence of operation and produces an output on the time-slot 1 line.

CHANNEL COUNTER

Channel Counter U2250 is a binary counter that produces the Channel Address Code for the Column and Row Decoder stages and the Format Generator stage. This code instructs these stages to sequentially select and display the 8 channels of data from the plug-ins. Table 3-12 gives the 8 combinations of the Channel Address Code and the resultant channel selected with each combination.

TABLE 3-12
Channel Address Code
SN B031766 & Below

| Pin 11 U2250 | Pin 8 U2250 | Pin 9 U2250 | Channel Displayed |
|-----------------|----------------|----------------|-----------------------------|
| LO | LO | LO | Channel 2 Left Vertical |
| LO | LO | HI | Channel 1 Left Vertical |
| LO | HI | LO | Channel 2 Right Vertical |
| LO | HI | HI | Channel 1 Right Vertical |
| HI | LO | LO | Channel 2 A Horizontal |
| HI | LO | HI | Channel 1 A Horizontal |
| HI | HI | LO | Channel 2 B Horizontal |
| HI | HI | HI | Channel 1 B Horizontal |

SINGLE-SHOT LOCKOUT

The Single-Shot Lockout stage allows a single readout frame (8 complete words) to be displayed on the crt, after which the Readout System is locked out, so further readout displays are not presented until the circuit is reset. Integrated circuit U2120C and U2120B are connected to form a bistable flip-flop. For free-run operation, pin 8 of U2120C is held HI. This activates U2120C and results in a LO output level at pin 10, enabling the Timer stage to operate in a free-running manner.

The output of the Single-Shot Lockout stage remains LO to allow U2126 to operate in the free-running mode until a LO is received at pin 8 of U2120C. When this occurs, the output level at pin 10 of U2120C does not change immediately. However, the Single Shot Lockout circuit is now enabled.

If the Channel Counter has not completed word 8, the Readout System continues to operate in the normal manner. When word 8 is completed, the negative-going end-of-frame pulse is produced at pin 11 of U2250 as the Channel Counter shifts to the code necessary to display word one. This pulse is applied to pin 3 of U2120A which produces a HI at pin 6 of U2120B because of the momentary LO at pin 2. The HI at pin 6 produces a LO at pin 4 which causes pin 9 of U2120C to go LO. Because pin 8 is already LO, pin 10 goes HI. This disables the Timer stage, so it operates in the Display-skip mode.

The Single-Shot Lockout stage remains in this condition until a positive-going trigger pulse is applied to pin 8 of U2120C. This trigger pulse produces a LO at pin 10 of U2120C to enable U2126 and disable U2120B. Now, the Timer stage can operate in the normal manner for another complete frame. When word 8 is completed, the Channel Counter produces another end-of-frame pulse to again lock out the Timer stage.

ENCODING THE DATA

Data is conveyed from the plug-in units to the Readout System in the form of an analog (current level) code. The characters that can be selected by the encoded data are shown on the Character Selection Matrix (see Fig. 3-9). Each character requires two currents to define it; these currents are identified as the column current and the row current, corresponding to the column and row of the matrix. The column and row data is encoded by programming the plug-in units. Figure 3-15 shows a typical encoding scheme using resistors for a voltage-sensing amplifier plug-in unit. Notice that the 10 TS (time slot) pulses produced by the Time-Slot Counter stage are connected to the plug-in unit. However, time-slots 5, 6, and 10 are not used by the plug-in unit to encode data when using the Standard Readout Format. (See Table 3-11 for Standard Readout Format.) The amplitude of the time-slot pulse is exactly -15 volts as

determined by the Timer stage. Therefore, the resultant output current from the plug-in units can be accurately controlled by the programming resistors in the plug-in units.

For example, in Figure 3-15 resistors R10 through R90 control the row analog data, which is connected back to the Readout System. Figure 3-16 shows an idealized

output current waveform of row analog data, which results from the time-slot pulses. Each of the row-current levels shown in these waveforms correspond to 100 microamperes of current. The row numbers on the left-hand side of the waveform correspond to the rows in the Character Selection Matrix (see Fig. 3-9). The row analog data is connected back to the Readout System via terminal B37 of the plug-in interface.

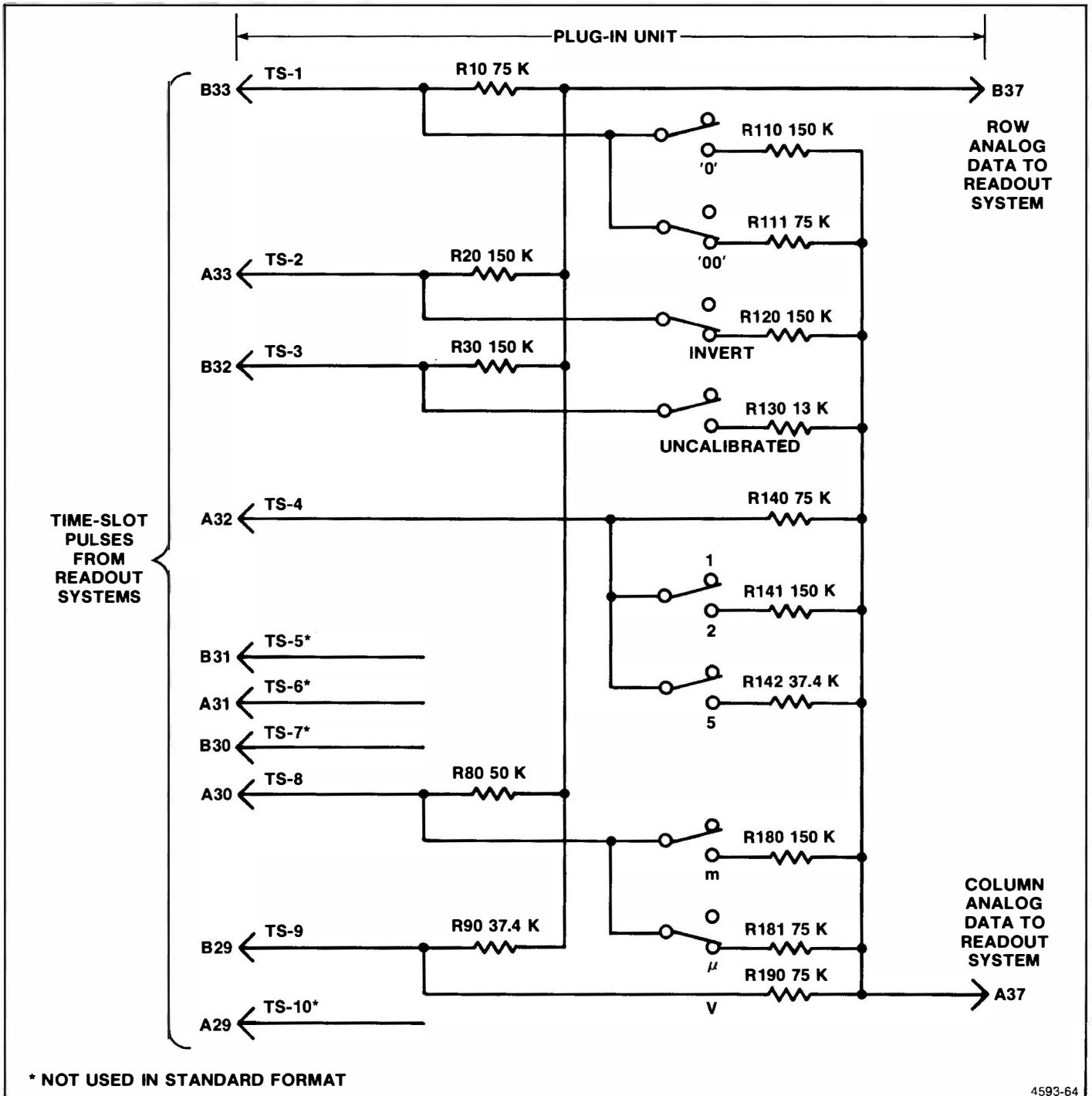

Figure 3-15. Typical encoding scheme for voltage-sensing plug-in unit. Coding shown for deflection factor of 100 microvolts.

Theory of Operation—7904A

The column analog data is defined by resistors R110 through R190. The program resistors are connected to the time-slot lines by switch closures to encode the desired data. The data, as encoded by the circuit shown in Figure 3-15, indicates a 100 microvolt sensitivity with the crt display inverted and calibrated deflection factors. This results in the idealized output current waveforms shown in Figure 3-16 at the column analog data output, terminal A37 of the plug-in interface.

Resistor R111, connected between time-slot 1 and the column analog data output, encodes two units of current during time-slot 1. Referring to the Character Selection Matrix, Figure 3-9, two units of column current, along with the two units of row current encoded by resistor R10 (row 3), indicates that two zeros should be added to the display. Resistor R120 adds one unit of column current during time-slot 2 and, along with the one unit of current from the row output, the Readout System is instructed to add an invert arrow to the display. Resistor R130 is not connected to the time-slot 3 line, since the deflection factor is calibrated. Therefore, there is no display on the crt during TS-3. (See Display-Skip Generator for further information.)

During time-slot 4, two units of column current are encoded by R140. There is no row current encoded during this time-slot; this results in the numeral 1 being displayed on the crt. Neither row nor column analog data is encoded during time-slots 5, 6, and 7 as defined by the Standard Readout Format. During time-slot 8, two units of column current and three units of row current are encoded by resistors R181 and R80, respectively. This addresses the μ prefix in the Character Selection Matrix. The final data output is provided from time-slot 9 by R190 connected to the column output and R90 to the row output. These resistors encode two units of column current and four units of row current to cause a V (volts) symbol to be displayed. Time-slot 10 is not encoded, in accordance with the Standard Readout Format. The resultant crt readout will be $\div 100 \mu\text{V}$.

In the above example, the row analog data was programmed to define which row of the Character Selection Matrix was addressed to obtain information in each time-slot. The column data changes to encode the applicable readout data as the operating conditions change. For example, if the variable control of the plug-in unit was activated, R130 would be connected between time-slot 3 and the column analog data output line. This encodes 10 units of column current (see shaded area in time-slot 3 of the waveform shown in Fig. 3-16). Since one unit of row current is also encoded during this time-slot by R30, a > (greater than) symbol is added to the display. The crt readout will now show > 100 μV . In a similar manner, the other switches can change the encoded data for the column output and thereby change the readout display. See the descriptions which follow for decoding this information.

The column analog data encoded by most plug-in units can be modified by attenuator probes connected to the input connectors of amplifier plug-in units. A special coding ring around the input connector of the plug-in unit senses the attenuation ratio of the probe (with readout-encoded probes only). The probe contains a circuit that provides additional column current. For example, if a 10X attenuator probe is connected to a plug-in unit encoded for 100 microvolts as shown in Figure 3-15, an additional unit of current is added to the column analog data during time-slot 1. Since two units of current were encoded by R111, this additional current results in a total of three units of column analog current during this time-slot. Referring to the Character Selection Matrix, three units of column current, along with the two units of row current encoded by R10, indicates that the prefix should be shifted one column to the left. Since this instruction occurs in the same time-slot that previously indicated that two zeros should be added to the display and only one instruction can be encoded during a time-slot, the zeros do not appear in the display. The crt readout will now be changed to 1

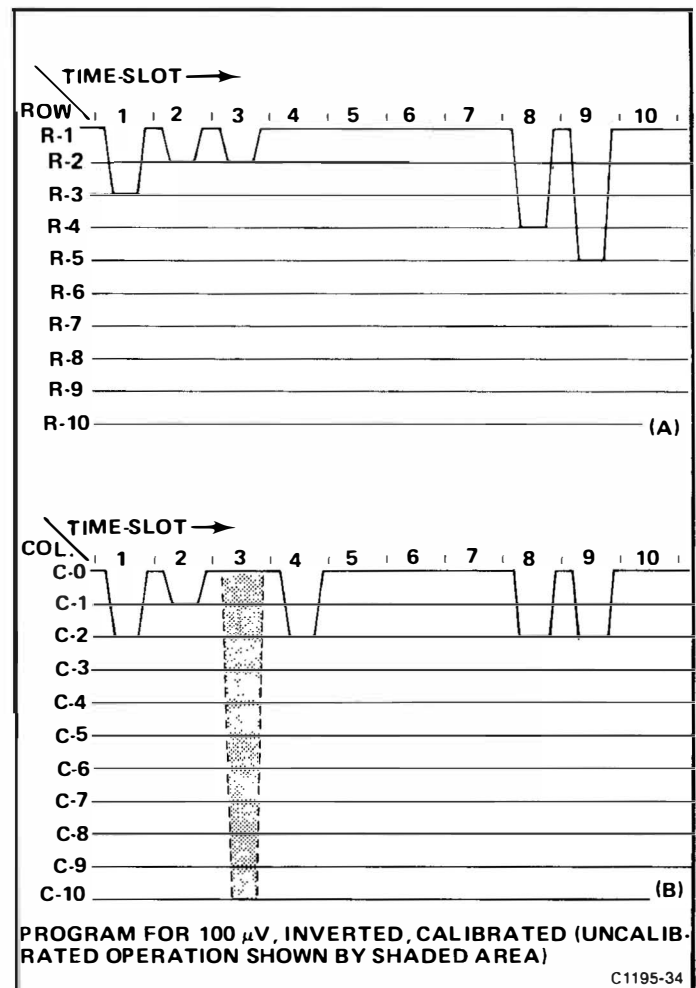

Figure 3-16. Idealized current waveforms of (A) Row analog data and (B) Column analog data.

mV (readout program produced by plug-in same as for previous example).

Three other lines of information are connected from the plug-in compartments to the Readout System. The column and row analog data from channel 2 of a dual-channel plug-in are connected to the Readout System through terminals A38 and B38 of the plug-in interface, respectively. Force readout information is encoded on terminal A35; the function of this input is described under Column and Row Data Switches. The preceding information gave a typical example of encoding data from an amplifier plug-in unit. Specific encoding data and circuitry is shown in the individual plug-in unit manuals.

COLUMN AND ROW DATA SWITCHES

The encoding data from the plug-in units is connected to the Column and Row Data Switch stages. A column-data line and a row-data line convey analog data from each of the 8 data sources (2 channels from each of the 4 plug-in compartments).

The Column Data Switch U2190 and the Row Data Switch U2180 receive the Channel Address Code from the Channel Counter (refer to Diagram 6 at the rear of this manual). This binary code directs the Column Data Switch and the Row Data Switch to the channel which should be the source of the encoding data. Table 3-12 gives the eight combinations of the Channel Address Code and the resultant channel selected with each combination. These stages have nine inputs and provide a time-multiplexed output at pin 7, which includes the information from all of the input channels. Eight of the nine inputs to each stage originate in the plug-in units; the ninth input comes from a special data-encoding network composed of resistors R2191 through R2199 and R2201 through R2209. (See Zeros Logic and Memory description for further information on ninth channel.)

In addition to the encoding data inputs from the plug-in units, inputs are provided to the Column Data Switch from the VERTICAL MODE and HORIZONTAL MODE switches to inhibit the readout for any plug-in unit(s) not selected for display. When a unit is not selected, the line corresponding to the opposite channel is HI to forward bias the associated diodes: CR2162 and CR2163, CR2166 and CR2167, CR2170 and CR2171, or CR2174 and CR2175. The forward-biased diodes cause the channel switches to bypass the encoded data from the inhibited channel. However, since it may be desired to display information from special-purpose plug-in units (even though they do not produce a normal waveform display on the crt), a feature is provided to over-ride the channel inhibit. This is done by applying a LO to the associated Force Readout input. The LO level diverts the HI channel-inhibit current and allows the data from this

plug-in unit to reach the Column Data Switch, even though it has not been selected for display by the mode switch.

Row Match adjustment, R2183, sets the gain of the Row Data Switch to match the gain of the Row Decoder for correct output. Column Match adjustment, R2214, performs the same function for the Column Data Switch stage.

DISPLAY-SKIP GENERATOR

The Display-Skip Generator is made up of Q2215, Q2223, Q2229, and Q2225. This stage monitors the time-multiplexed column data at the output of the Column Data Switch during each time-slot to determine if the information is valid data that should result in a crt display. Quiescently, about 100 microamperes of current flows through R2213 from Q2240 and the Zeros Logic and Memory stage. (The purpose of this quiescent current will be discussed in connection with the Zeros Logic and Memory stage.) This current biases Q2215A so that its base is about 0.2 volt more positive than the base of Q2215B in the absence of column data. Therefore, since Q2215A and Q2215B are connected as a comparator, Q2215A will remain on unless its base is pulled more negative than the base of Q2215B.

The analog data output from the Column Data Switch produces a 0.5 volt (approximately) change for each unit of column current that has been encoded by the plug-in unit. Whenever any information appears at the output of the Column Data Switch, the base of Q2215A is pulled more negative than the base of Q2215B, resulting in a negative (LO) Display-Skip output to the Timer stage through Q2225. Recall that a LO was necessary at the skip input of the Timer so it could perform the complete sequence necessary to display a character.

Transistors Q2223 and Q2229 also provide Display-Skip action. The end-of-word level connected to their emitters is LO only during time-slot 1. This means they are enabled only during this time-slot. These transistors allow the Zeros Logic and Memory stage to generate a Display-Skip signal during time-slot 1 when information that is not to be displayed on the crt has been stored in memory (further information is given under Zeros Logic and Memory).

COLUMN AND ROW DECODERS

The Column Decoder U2244 and Row Decoder U2185 sense the magnitude of the analog voltages at their inputs (pin 10) and produce a binary output on one of ten lines corresponding to the column or row data encoded by the plug-in unit. These outputs provide the Column Digital Data and Row Digital Data, which is used by the Character Generator stages to select the desired character for display on the crt. The column and row data is also used throughout the Readout System to perform other functions.

Theory of Operation—7904A

The input current at pin 9 of the Column Decoder stage is steered to only one of the ten Column Digital Data outputs. When a Display-Skip signal is present (collector of Q2225 HI), pin 9 is pulled HI through CR2226. This ensures that no current is connected to the Character Generator stage under this condition. Notice the corresponding input on the Row Decoder. This input is connected to ground and causes only one of the ten row outputs to saturate to ground.

The network at the input of the Row Decoder, made up of Q2153 and its associated components, is a Row-14 detector that produces the Jump Command. This row current is encoded by special-purpose plug-ins to cause all or part of a word to be jumped. Whenever row 14 (13 units of row current, or 1.3 milliamperes) is encoded, the base of Q2153 is pulled negative enough so that this transistor is reverse biased to produce a HI Jump Command output at its collector. The Jump Command is connected to the Word Trigger stage to advance the Channel Counter to the next word and to reset the Time-Slot Counter to time-slot 1.

ZEROS LOGIC AND MEMORY

The Zeros Logic and Memory stage U2232 stores data encoded by the plug-in units to provide zeros-adding and prefix-shifting logic for the Readout System. The Strobe pulse at pin 15 goes positive when the data has stabilized and can be inspected. This activates the Zeros Logic and Memory stage so that it can store the encoded data.

Typical output waveforms of the five possible input conditions that can occur are shown in Figure 3-17. When time-slot 1 occurs, a store command is given to all of the memories. If the plug-in units encoded data for column 1, 2, 3, 4, or 10 during time-slot 1, the appropriate memory (or memories) is set. Notice that row 3 information from the Row Decoder must also be present at pin 16 for data to be stored in the memory of U2232.

If data was encoded during time-slot 1, a negative-going output is produced at pin 7 while the memories are being set. This negative-going pulse is connected to the base of Q2229 in the Display-Skip Generator to produce a Display-Skip output. Since the information encoded during time-slot 1 was only provided to set the memories and not intended to be displayed on the crt at this time, the Display-Skip output prevents a readout display during this time-slot.

During time-slot 5, a memory within U2232 is interrogated. If information was stored in this memory, a positive-going output is produced at pin 7. This pulse is connected to pin 10 of the Column Decoder through Q2240 to add one unit of current at the input of the Column Decoder. This produces a zero after the character displayed during time-slot 4. During time-slot 6, another memory within U2232 is interrogated to see if

another zero should be added. If another zero is necessary, a second positive output is produced at pin 7, which again results in a column 1 output from the Column Decoder and a second 0 in the crt display.

Finally, another memory within U2232 is interrogated during time-slot 8 to determine whether the prefix should be changed, or left at the value that was encoded. If data has been encoded that calls for a shift in prefix, a negative-going output level is produced at pin 7. This negative level subtracts one unit of column current from the data at the input to the Column Decoder. Notice, on the Character Selection Matrix of Figure 3-9, that when row 4 is programmed, a reduction of one column results in a one-column shift of the prefix. For example, with the 100 μ V program shown in Figure 3-16, if the data received from the plug-in called for a shift in prefix, the crt readout would be changed to 1 mV (zeros deleted by program; see Encoding the Data).

The 100 microamperes of quiescent current through R2213 provided by Q2240 (see Display-Skip Generator) allows the prefix to be shifted from m (100 microamperes of column current, column 1) to no prefix (0 column current, column 0) so only the unit of measurement encoded during time-slot 9 is displayed. Notice that reducing the prefix program from column 1 to column 0 programs the Readout System to not display a character at this readout location.

A further feature of the Zeros Logic and Memory is the Identify function. If 10 units of column current are encoded by the plug-in unit along with row 3 during time-slot 1, the Zeros Logic and Memory produces a negative-going output pulse at pin 1 to switch the Column Data Switch and Row Data Switch to the ninth channel. Then, time-slot pulses 2 through 9 encode an output current through resistors R2191 and R2199 for column data and R2201 and R2209 for row data. This provides the current necessary to display the word IDENTIFY in the word position allotted to the channel that originated the Identify command. After completion of this word, the Column Data Switch and Row Data Switch continue with the next word in the sequence.

The Word Trigger signal from the Word Trigger stage is connected to pin 9 of U2232 through C2242. At the end of each word of readout information, this pulse goes LO. This erases the four memories in the Zeros Logic and Memory in preparation for the data to be received from the next channel.

CHARACTER GENERATOR

The Character Generator stage consists of five similar integrated circuits (U2270, U2272, U2274, U2276, U2278), which generate the X (horizontal) and Y (vertical) outputs at pins 16 and 1, respectively, to produce the character display on the crt. Each integrated circuit can produce 10 individual characters;

U2270 (designated "Numerals") can produce the numerals 0 through 9 shown in row 1 of the Character Selection Matrix (Fig. 3-9). Integrated circuit U2272 can produce the symbols shown in row 2 of the Character Selection Matrix and U2274 produces the prefixes and some letters, used as prefixes, shown in row 4. Integrated circuits U2276 and U2278 produce the remaining letters shown in rows 5 and 6 of the Character Selection Matrix.

All of the Character Generator stages receive the Column Digital Data from the Column Decoder U2244 in parallel. However, only one of the Character Generators receives row data at a particular time and only the stage receiving this row data is activated. For example, if column 2 is encoded, the five character Generators are enabled so that either a 1, >, μ, V, or an N can be produced. If row 4 has been encoded at the same time, only the Prefix Character Generator U2274 will produce

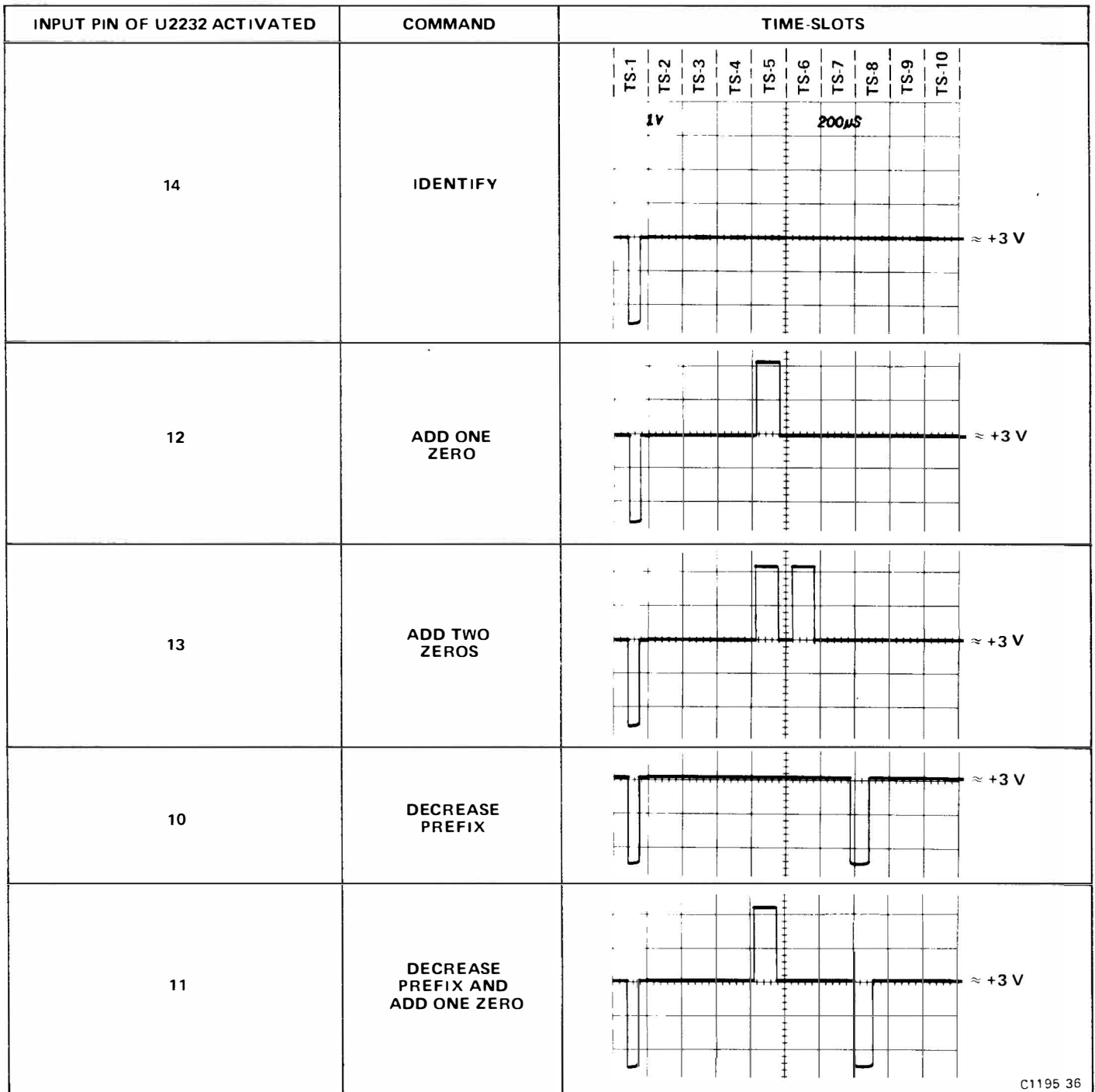

C1195 36

Figure 3-17. Typical output waveforms for Zeros Logic and Memory stage operation (at pin 7 of U2232).

Theory of Operation—7904A

an output to result in a “μ” being displayed. The activated Character Generator provides current output for the Format Generator to produce the selected character on the crt. In a similar manner, any of the characters shown in the Character Selection Matrix can be displayed by correct addressing of the row and column.

DECIMAL POINT LOGIC AND CHARACTER POSITION COUNTER

Decimal Point Logic and Character Position Counter U2260 performs two functions. The first function is to add a staircase current to the X (horizontal) signal to space the characters horizontally on the crt. After each character is generated, the negative-going edge of the Ready signal at pin 5 advances the Character Position Counter. This produces a current step output at pin 3 which, when added to the X signal, causes the next character to be displayed one character space to the right. This stage can also be advanced when a Space instruction is encoded so a space is left between the displayed characters on the crt. Row 10 information from the Row Decoder is connected to pin 4 of U2260. When row 10 and column 0 are encoded, the output of this stage advances one step to move the next character another space to the right. However, under this condition, no display is produced on the crt during this time-slot, since the Character Generators are not activated.

Time-slot pulses 1, 2, and 3 are also connected to pin 4 of U2260 through VR2262, VR2263, and VR2264 respectively and to R2262 and R2265. This configuration adds a space to the displayed word during time-slots 1, 2, and 3 even if information is not encoded for display

during these time-slots. With this feature, the information displayed during time-slot 4 (scaling data) always starts in the fourth character position whether data has been displayed in the previous time-slots or not. Therefore, the resultant crt display does not shift position as normal-invert or cal-uncal information is encoded. The Word Trigger pulse connected to pin 8 resets the Character Position Counter to the first character position at the end of each word.

The Decimal Point Logic portion of this stage allows decimal points to be added to the crt display. With the Standard Readout Format, row 7, encoded coincident with columns 3 through 7, addresses a decimal at one of the five locations identified in row 7 of the Character Selection Matrix (Fig. 3-9). This instruction refers to the decimal point location in relation to the total number of characters possible in one word (see Fig. 3-18). For example, column 3 encoded with row 7 during time-slot 1 places a decimal point in location number 3. As shown in Figure 3-18, this displays a decimal point after the third character that can be displayed on the crt. (The first three time-slots produce a space whether data is encoded or not; see previous paragraph.)

When decimal-point data is encoded, the crt is unblanked so a readout display is presented. Since row 7 does not activate any of the five Character Generators, the crt beam is deflected vertically by the application of row-7 data to the Y input of the Format Generator through R2278 and R2280. This places the decimal point between the characters along the bottom line of the readout word. After the decimal point is produced in the addressed location, the crt beam returns to the location indicated by the Character Position Counter to produce the remainder of the display.

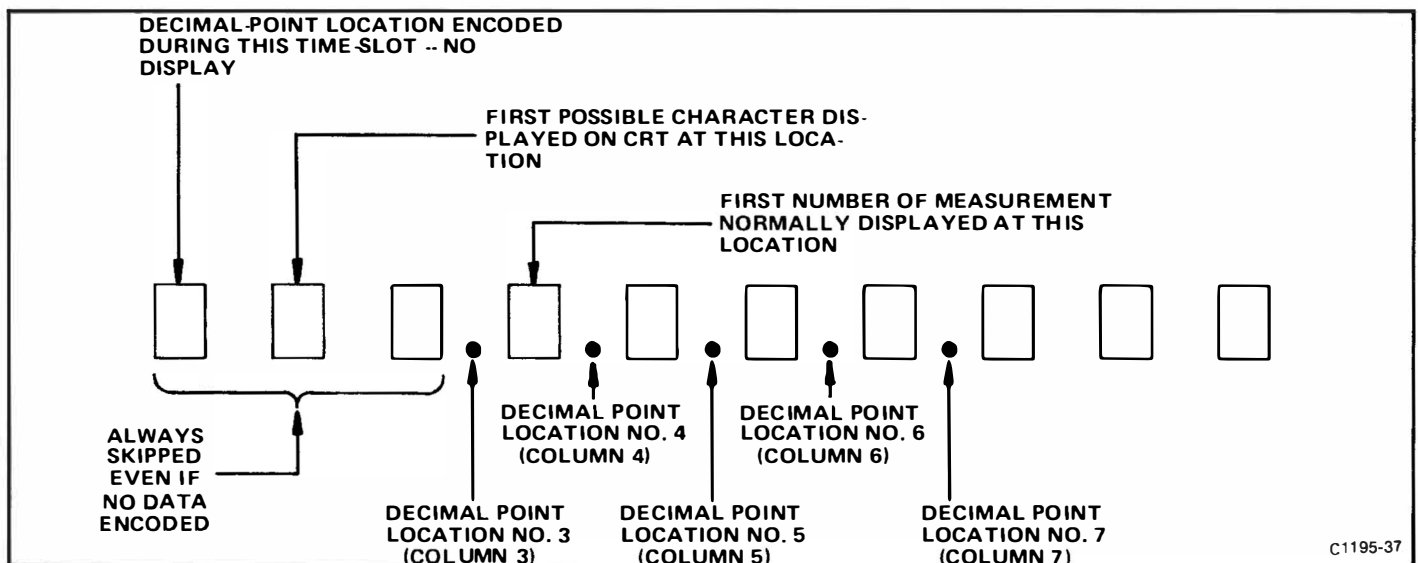

Figure 3-18. Readout word relating 10 possible character locations to the decimal point instructions that can be encoded; and the resultant crt display.

FORMAT GENERATOR

The X- and Y-deflection signals produced by the Character Generator stage are connected to pins 2 and 7, respectively, of the Format Generator. The Channel Address Code from the Channel Counter is also connected to pins 1, 8, and 15 of this stage. The Channel Address Code directs the Format Generator to add current to the X and Y signals to deflect the crt beam to the area of the crt associated with the plug-in channel that originated the information (see Fig. 3-8). The Channel Address Code and the resultant word positions are shown in Table 3-12. The Ready signal at pin 13 (coincident with the X/Y Inhibit Command output) activates this stage when a character is to be displayed on the crt. Variable resistor R2273 determines the horizontal and vertical size of the displayed characters. The character position current from the Decimal Point Logic and Character Position Counter stage is added to the X (horizontal) input signal to space the characters horizontally on the crt (see previous discussion).

Y-OUTPUT

The Y-output signal at pin 6 of Format Generator U2284 is connected to the Y-Output amplifier Q2287 and Q2299. This stage provides a low impedance load for the Format Generator while providing isolation between the Readout System and the driven circuits. Vertical Separation adjustment R2291 changes the gain of this stage to control the vertical separation between the readout words displayed at the top and bottom of the graticule area.

X-OUTPUT

The X-Output amplifier Q2286 and Q2296 operates like the Y-Output amplifier, to provide the horizontal deflection from the readout signal available at pin 4 of U2284. The gain of this stage is fixed by the values of the resistors in the circuit.

DISPLAY SEQUENCE

Figure 3-19 shows a flow chart for the Readout System. This chart illustrates the sequence of events that occurs in the Readout System each time a character is generated and displayed on the crt.



READOUT SYSTEM (SN B031767 & Above)

The Readout System provides an alphanumeric display of information encoded by the plug-in units. This display is presented on the CRT and is written by the CRT beam on a shared basis with the analog waveform display.

The following terms are used to describe the Readout System:

Character.—A single number, letter, or symbol displayed on the CRT, either alone or in combination with other characters.

Word.—A group of related characters. In the Readout System, a word can consist of up to 10 characters.

Frame.—A display of all words for a given operating mode and plug-in combination. Up to 8 words can be displayed in one frame. Figure 3-8 shows the position of each word in a complete frame.

Column.—One of the vertical lines in the Character Selection Matrix (see Fig. 3-20). Columns C-0 (column zero) through C-10 (column 10) can be addressed by the system.

Row.—One of the horizontal lines in the Character Selection matrix. Rows R-1 (row 1) through R-10 (row 10) and R-14 (row 14) can be addressed by the system.

Time-Slot.—A location in a pulse train. In the Readout System, the pulse train consists of 10 negative-going pulses. Each time-slot pulse is assigned a number between 1 and 10. For example, the first time-slot is TS-1.

Time-Multiplexing.—Transmission of data from two or more sources over a common path by using different time intervals for different signals.

Hexidecimal.—The hexidecimal numbering system uses the numerals 0 through 9 and the letters A through F to represent the sixteen possible combinations of four binary digits.

Octal.—The octal numbering system uses the numerals 0 through 7 to represent the eight possible combinations of three binary digits.

Binary Coded Decimal.—The Binary Coded Decimal system uses ten unique combinations of four binary digits to represent the decimal numbers 0 through 9.

DISPLAY FORMAT

Up to 8 words of readout information can be displayed on the CRT. The position of each word is fixed and is directly related to the plug-in unit from which it originated. Figure 3-8

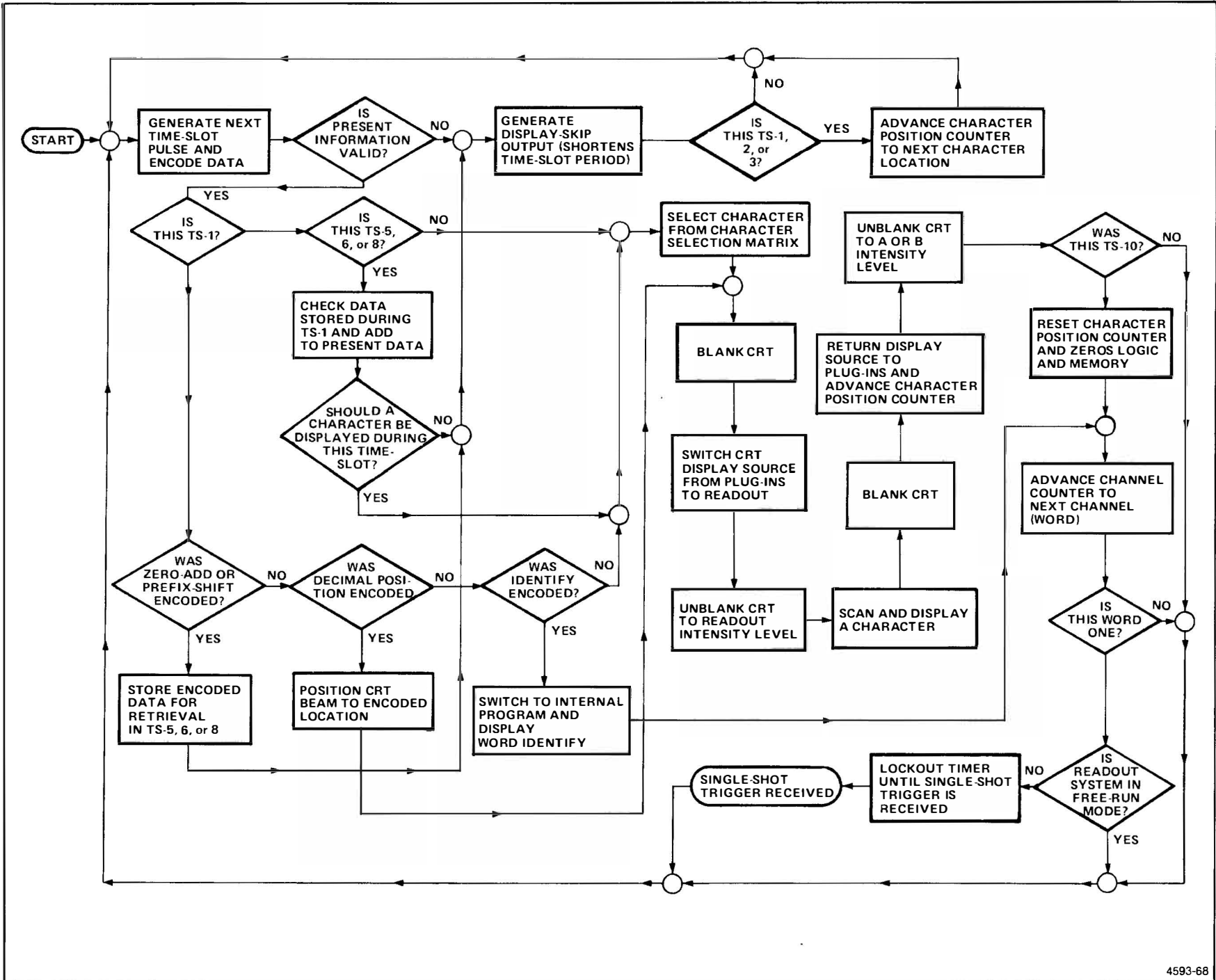

Figure 3-19. Flow chart for character generation by the Readout System.

shows the area of the graticule where the readout from each plug-in unit is displayed. Notice that Channel 1 of each plug-in unit is displayed within the top division of the CRT, and Channel 2 is displayed directly below within the bottom division. Figure 3-10 shows a typical display where only Channel 2 of the Right Vertical and B Horizontal units is selected for display.

Each word in the readout display can contain up to 10 characters, although the typical display will contain between 2 and 7 characters per word. The characters are selected from the Character Selection Matrix shown in Figure 3-20. In addition, 13 operational addresses are provided for special instructions to the Readout System. The unused locations in the Matrix (shaded area) are available for future expansion of the Readout System. The method of addressing the locations in the Character selection Matrix is described in the following discussion.

DEVELOPING THE DISPLAY

This description is intended to relate the basic function of each stage to the operation of the overall Readout System. Detailed information on circuit operation is given later.

The key block in the Readout System is the Timer Stage (see schematic). This stage produces the basic signals that establish the timing sequences within the Readout System. The period of the timing signal is about 250 microseconds (it drops to about 210 microseconds when Display-Skip is received; see detailed description of Timer stage for further information). This stage also produces control signals for other stages within this circuit, and inhibit signals to the Vertical Amplifier, Horizontal Amplifier, and Logic circuits, which allow a readout display to be presented. The Time-Slot Counter stage receives a trapezoidal voltage signal from the Timer stage and directs it to one of ten output lines. These output lines are labeled TS-1 through TS-10 (time-slots 1 through 10) and are connected to the vertical and horizontal plug-in compartments, as well as to various stages within the Readout System. The output lines are energized sequentially, so there is a pulse on only one of the 10 lines during any 250-microsecond timing period. After the Time-Slot Counter stage has counted time-slot 10, it produces an End-of-Word pulse which advances the system to the next channel.

Two output lines (row and column) are connected from each channel of the plug-in unit back to the Readout System. Data is typically encoded on these output lines by connecting resistors between them and the time-slot input lines. The resultant output is a sequence of 10 analog current levels that range from 0 to 1 millampere (100 microamperes/step) on the row and column output lines. This row and column corresponds to the row and column of the Character Selection Matrix in Figure 3-20. The standard format for encoding information onto the output lines is given in Table 3-11 (Special-purpose plug-in units may have their own format for readout and these special formats will be defined in the manuals for these units).

The encoded column and row data from the plug-in units is selected by the Column Data Switch and Row Data Switch stages respectively. These stages take the analog current from the 8 data lines (2 channels from each of the 4 plug-in compartments) and produce a time-multiplexed analog voltage output containing all of the column and row information from the plug-ins. The Column Data Switch and Row Data Switch are sequenced by the binary Channel Address Code from the Channel Counter.

The time-multiplexed output of the Column Data Switch is monitored by the Display-Skip Generator to determine if it represents valid information that should be displayed. Whenever information is not encoded in a time-slot, the Display-Skip Generator produces an output level to prevent the Timer stage from producing the control signals that normally interrupt the CRT display and present a character.

The analog outputs of the Column Data Switch and Row Data Switch are connected to the Column Decoder and Row Decoder stages respectively. These stages sense the magnitude of the analog voltage input and produce an output current on one of ten lines. The outputs of the Column Decoder stage are identified as C-1 through C-10 (column 1 through 10) corresponding to the encoded column information. Likewise, the outputs of the Row Decoder stage are identified as R-1 through R-10 (row 1 through 10) corresponding to the encoded row information. The row and column outputs are then converted to Binary Coded Decimal and used to address memory locations within the Character Generator. These outputs are also used at other points within the system to indicate when certain information has been encoded. One such stage is the Zeros Logic and Memory. During time-slot 1 (TS-1), this stage checks if zero-adding or prefix-shifting information has been encoded by the plug-in unit, and stores it in the memory until time-

| Hexadecimal from U2246 → | | F | E | D | C | B | A | 9 | 8 | 7 | 6 | F | |
|--|-----------------------|-----------------|--------------------------------|----------------------|----------------------------|---|--|--|--|----------|----------|-----------|----------|
| Hexi- decimal from U2186 ↓ | Column Number → | C-0 | C-1 | C-2 | C-3 | C-4 | C-5 | C-6 | C-7 | C-8 | C-9 | C-10 | |
| | Row Number ↓ | Current (mA) | 0 | 0.1 | 0.2 | 0.3 | 0.4 | 0.5 | 0.6 | 0.7 | 0.8 | 0.9 | ≥1.0 |
| E | R-1 | 0 | 0 | 1 | 2 | 3 | 4 | 5 | 6 | 7 | 8 | 9 | |
| D | R-2 | 0.1 | ! | < | ! | / | + | - | + | C | Δ | > | |
| C | R-3 | 0.2 | Add one zero* | Add two zeros* | Reduce one prefix* | Reduce prefix and add one zero* | | | | | | IDENTIFY* | |
| B | R-4 | 0.3 | <i>m</i> | <i>μ</i> | <i>n</i> | <i>p</i> | <i>X</i> | <i>K</i> | <i>M</i> | <i>G</i> | <i>T</i> | <i>R</i> | |
| A | R-5 | 0.4 | SKIP* | <i>S</i> | <i>V</i> | <i>A</i> | <i>W</i> | <i>H</i> | <i>d</i> | <i>B</i> | <i>c</i> | <i>Ω</i> | <i>E</i> |
| 9 | R-6 | 0.5 | | <i>U</i> | <i>N</i> | <i>L</i> | <i>Z</i> | <i>Y</i> | <i>P</i> | <i>F</i> | <i>J</i> | <i>Q</i> | <i>D</i> |
| 8 | R-7 | 0.6 | | | Decimal point no. 3* | Decimal point location no. 4* | Decimal point location no. 5* | Decimal point location no. 6* | Decimal point location no. 7* | | | | |
| 7 | R-8 | 0.7 | | | | | | | | | . | | |
| 6 | R-9 | 0.8 | | | | | | | | | | | |
| F | R-10 | 0.9 | Add space in display* | | | | | | | | | | |
| F | R-14 | 1.3 | | ← JUMP* → | | | | | | | | | |

* Operational address.



Unused locations. Available for future expansion of Readout System.

Figure 3-20. Character selection matrix for 7904A Readout System (SN B031767 & Above).

slots 5, 6, or 8. After storing this information, it triggers the Display-Skip Generator stage so that there is no display during time-slot 1 (as defined by Standard Readout Format; see Table 3-11). When time-slots 5, 6, and 8 occur, the memory is addressed and any information stored there during time-slot 1 is transferred to the input of the Column Decoder stage to modify the analog data during the applicable time-slot.

Another operation of the Zeros Logic and Memory stage is to produce the Identify function. When time-slot 1 is encoded for Identify (column 10, row 3), this stage produces an output level connected with the Row Decimal-to-BCD Converter and the Row and Column Data Switches. This output level connects the Column Data Switch with a coding network within the Readout system to produce an analog current during time-slots 2 through 9. The current is then converted to Binary Coded Decimal and combined with the Row Decimal-to-BCD Converter output to address locations within the Character Generator necessary to display "IDENTIFY" on the CRT. The Zeros Logic and Memory stage is reset after each word by the End-of-Word pulse.

Each character displayed on the CRT consists of a series of connected points within an 8-point by 8-point grid. The Character Generator contains grid locations of the points required to create any of the 50 possible characters shown in the Character Selection Matrix of Figure 3-20. The row and column data encoded during a time-slot are converted to BCD and used to address a location within the Character Generator containing the first grid point of the character to be displayed. The 4-bit binary output from the Lower Order Address Generator is combined with the address created by the row and column data to provide the other grid points necessary to complete the character.

Only one character is addressable in any one time-slot or a space can be added into the displayed word by the Horizontal Character Position Counter stage, when encoded by the plug-in. The latter stage counts the number of characters generated and produces an output current to step the display one character position to the right for each character. In addition, the character position is advanced once during each of time-slots 1, 2, and 3, whether a character is generated during these time-slots or not. This action fixes the starting point of the standard-format display such that the first digit of the scaling factor always starts at the same point within each word regardless of the information encoded in time-slot 1, 2, or 3 preceding this digit. Also, by encoding row 10 and column 0 during any time-slot, a blank space can be added to the display. Decimal points can be added to the display at any time by addressing the appropri-

ate row and column (See Character Selection Matrix for location of decimal points). The Horizontal Character Position Counter stage is reset after each word by the Word Trigger pulse.

The Character Generators binary output is shaped by the X and Y Vector Generators into the appropriate X and Y-Axis signals to create characters. The Vector Amplifier outputs are amplified by the X and Y Output Amplifiers for use by the instruments horizontal and vertical deflection systems. The Channel Counter output is also used by these stages so the display from each channel is positioned to the area of the CRT which is associated with the plug-in and channel originating the word (see Fig. 3-8). The character positioning current or decimal positioning current generated by the Horizontal Character Position Counter or Decimal Point Logic stages is added to the X (horizontal) signal at the input to the X Output Amplifier, providing horizontal positioning of the characters within each word.

The Word Trigger stage produces a trigger from the End-of-Word pulse generated by the Time-Slot Counter stage after the tenth time-slot. This Word Trigger pulse advances the Channel Counter to display the information from the next channel or plug-in. This Word Trigger stage can also be advanced to jump a complete word, or a portion of a word, when a Jump Command is received from the Row Data Switch stage.

TIMER

The Timer stage produces the timing sequence for all circuits within the Readout System. This stage produces six time-related output waveforms (see Fig. 3-11). The triangle waveform produced at pin 6 forms the basis for the remaining signals. The basic period of this triangle waveform is about 250 microseconds, as controlled by RC network R2135 and C2135. The triangle waveform is clipped and amplified by U2126 to form the trapezoidal output signal at pin 10. The amplitude of this output signal is exactly 15 volts, as determined by U2126 (exact amplitude is necessary to accurately encode data in plug-in units; see Encoding the Data). The trigger output at pin 5 provides the switching signal for the Time-Slot Counter.

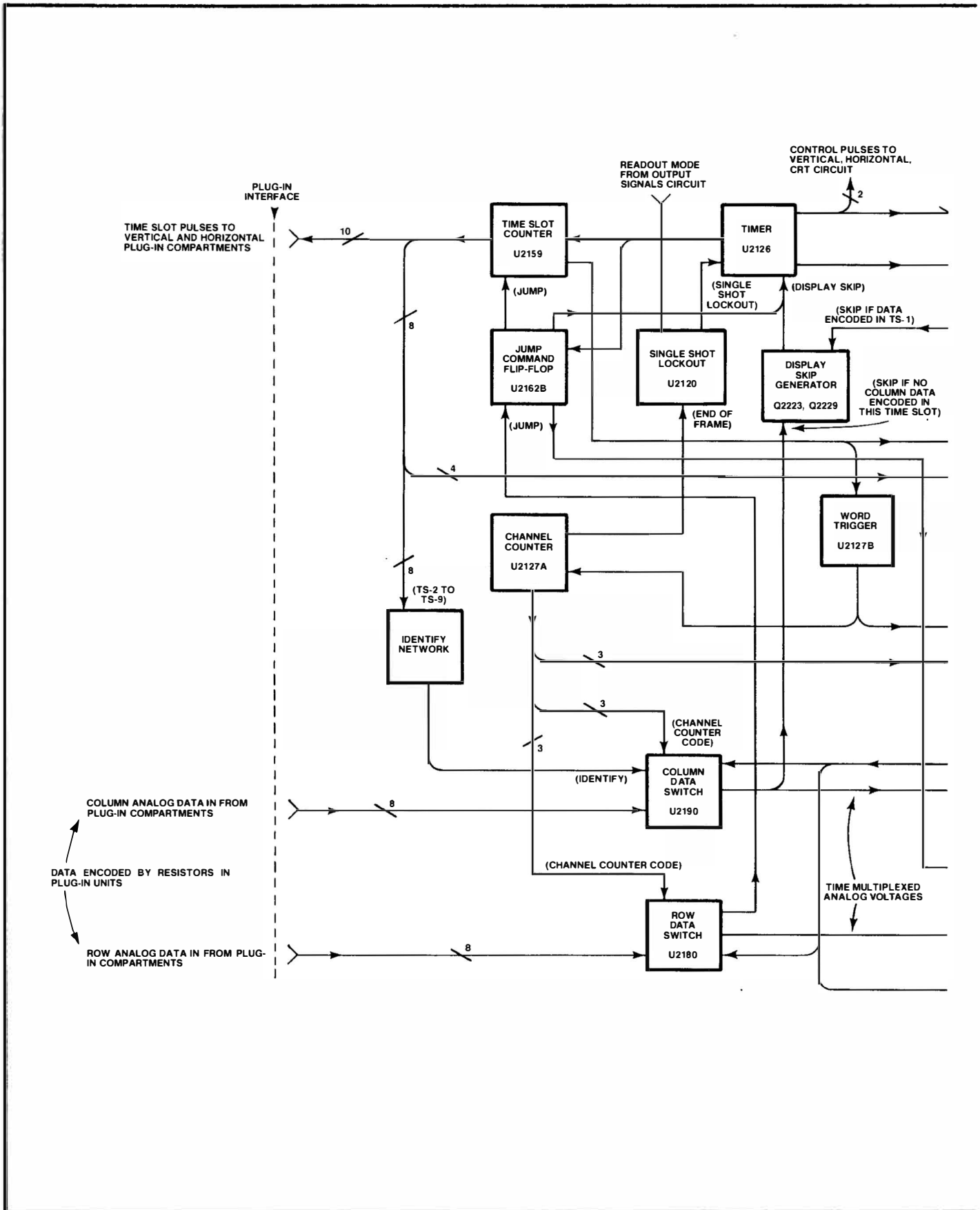
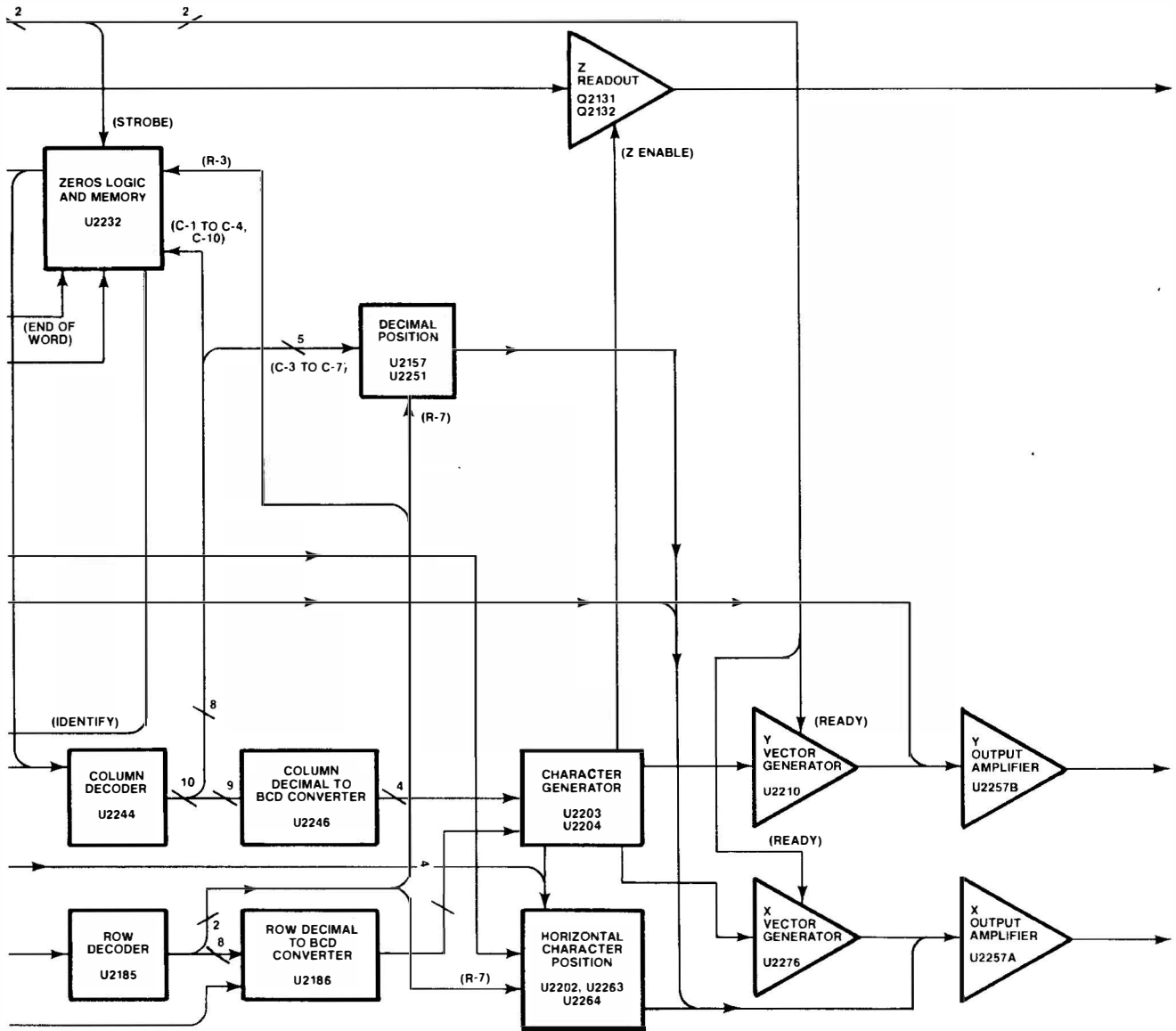

Figure 3-21. Detailed block diagram of the Readout System (SN B031767 & Above).



(1429-31)1767-117

Figure 3-21. Detailed block diagram of the Readout System (SN B031767 & Above).

Theory of Operation—7904A

The signals at pin 12, 13, and 14 are produced only when the triangle waveform is on its negative slope and the trapezoidal waveform has reached the lower level. The timing sequence of these waveforms is important to the operation of the Readout System (see expanded waveforms in Fig. 3-12). The Z-Axis inhibit command at pin 14 is produced first. This negative-going signal provides a blanking pulse to the Z-Axis Logic stage to blank the CRT before the display is switched to the Readout System. It also produces the strobe pulse through Q2138 and CR2139 which is connected to pin 15 of U2232.

The purpose of this configuration is to prevent the Zeros Logic and Memory stage U2232 from storing incorrect data during the quiescent period of the strobe pulse. When the strobe pulse goes positive, CR2139 is reverse biased to disconnect Q2138 and allow U2232 to operate in the normal manner.

The next signal to be produced is the X-Y Inhibit Command at pin 13. This positive-going signal disconnects the plug-in signals from the vertical and horizontal deflection systems. The Ready signal is also derived from this output and connected to the Character Generator stage and the two Output Amplifier stages.

The Z Readout output at pin 12 is produced next. This current is connected to the CRT circuit to unblank the CRT to the intensity level determined by the voltage on the Readout Intensity line.

The Timer stage operates in one of two modes as controlled by the Display-Skip level at pin 4. The basic mode just described is a condition that does not occur unless all ten characters of each word (80 characters total) are displayed on the CRT. Under typical conditions, only a few characters are displayed in each word. The Display-Skip level at pin 4 determines the period of the Timer output signal. When a character is to be generated, pin 4 is LO and the circuit operates as just described. However, when a character is not to be displayed, a HI level is applied to pin 4 of U2126 through CR2125 from the Display-Skip Generator stage. This signal causes the Timer to shorten its period of operation to about 210 microseconds. The waveforms in Figure 3-13 show the operation of the Timer stage when the Display-Skip condition occurs for all positions in a word. Notice that there is no output at pins 12, 13, and 14 under this condition. This means that the CRT display is not interrupted to display characters. Also notice that the triangle waveform at pin 6 does not go as far negative, and that the negative portion of the trapezoidal waveform at pin 10 is shorter. Complete details on operation of the Display-Skip Generator are given later.

The Timer operation is also controlled by the Single-Shot Lockout level at pin 2. If this level is LO, the Timer operates

as just described. However, if the Single-Shot Lockout stage sets a HI level at this pin, the Timer stage is locked out and can not produce any output signals (see Single-Shot Lockout description for further information).

A negative voltage on the readout intensity line sets the intensity of the readout display independently of the A or B INTENSITY controls. The Readout Intensity line also provides a means of turning the Readout System off when a readout display is not desired. When the Readout Intensity line is left open, the current from pin 11 of U2126 is interrupted, and at the same time, a positive voltage is applied to pin 4 through CR2124. The positive voltage switches the stage to the same conditions as were present under the Display-Skip condition. Therefore, the CRT display is not interrupted to present characters. However, time-slot pulses continue to be generated.

TIME-SLOT COUNTER

Time-Slot Counter U2159 is a sequential switch which directs the trapezoidal waveform input at pin 8 to one of its 10 output lines. These time-slot pulses are used to interrogate the plug-in units to obtain data for the Readout System. The trigger pulse at pin 15 switches the Time-Slot Counter to the next output line, causing the output signal to be sequenced consecutively from time-slot 1 through time-slot 10. Figure 3-14 shows the time relationship of the time-slot pulses. Notice that only one line carries a time-slot pulse at any given time. When time-slot 10 is completed, a negative-going end-of-word pulse is produced at pin 2. The end-of-word pulse provides a drive pulse for the Word Trigger stage and also provides an enabling level to the Display-Skip Generator during time-slot 1 only.

Pin 16 is a reset input for the Time-Slot Counter. When this pin is held LO, the Time-Slot Counter resets to time-slot 1.

WORD TRIGGER

The Word Trigger U2127B is a single-shot multivibrator that provides a reset pulse for the Horizontal Character Position Counter stage. The negative-going end-of-word pulse from pin 2 of U2159 triggers the single shot and causes its output to go high at pin 11.

CHANNEL COUNTER

Channel Counter U2127A is a binary counter that produces the Channel Address Code for the Column and Row Decoder stages and the Output Amplifier stages. This code instructs these stages to sequentially select and display the 8 channels of data from the plug-ins. Table 3-13 gives the 8 combinations of the Channel Address Code and the resultant channel selected with each combination.

TABLE 3-13
Channel Address Code
SN B031767 & Above

| Pin 5 U2127 | Pin 4 U2127 | Pin 3 U2127 | Channel Displayed |
|----------------|----------------|----------------|-----------------------------|
| LO | LO | LO | Channel 1 Left vertical |
| LO | LO | HI | Channel 2 Left Vertical |
| LO | HI | LO | Channel 1 Right Vertical |
| LO | HI | HI | Channel 2 Right Vertical |
| HI | LO | LO | Channel 1 A Horizontal |
| HI | LO | HI | Channel 2 A Horizontal |
| HI | HI | LO | Channel 1 B Horizontal |
| HI | HI | HI | Channel 2 B Horizontal |

SINGLE-SHOT LOCKOUT

The Single-Shot Lockout stage allows a single readout frame (8 complete words) to be displayed on the CRT, after which the Readout System is locked out, so further readout displays are not presented until the circuit is reset. Integrated circuit U2120A and U2120B are connected to form a bistable flip-flop. For free-run operation, pin 8 of U2120C is held HI. This activates U2120C and results in a LO output level at pin 10, enabling the Timer stage to operate in a free-running manner.

The output of the Single-Shot Lockout stage remains LO to allow U2126 to operate in the free-running mode until a LO is received at pin 8 of U2120C. When this occurs, the output level at pin 10 of U2120C does not change immediately. However, the Single Shot Lockout circuit is now enabled.

If the Channel Counter has not completed word 8, the Readout System continues to operate in the normal manner. When word 8 is completed, the negative-going end-of-frame pulse is produced at pin 5 of U2127A as the Channel Counter shifts to the code necessary to display word one. This pulse is applied to pin 8 of U2120C, which produces a HI at pin 6 of U2120B because of the momentary LO at pin 9. The HI at pin 6 produces a LO at pin 4, which causes pin 3 of U2120A to go LO. Because pin 2 is already LO, pin 1 goes HI. This disables the Timer stage, so it operates in the Display-Skip mode.

The Single-Shot Lockout stage remains in this condition until a positive-going trigger pulse is applied to pin 2 of U2120A. This trigger pulse produces a LO at pin 1 of U2120A to enable U2126 and disable U2120B. Now, the Timer stage can operate in the normal manner for another complete frame. When word 8 is completed, the Channel Counter produces another end-of-frame pulse to again lock out the Timer stage.

ENCODING THE DATA

Data is conveyed from the plug-in units to the Readout System in the form of an analog (current level) code. The characters that can be selected by the encoded data are shown on the Character Selection Matrix (see Fig. 3-20). Each character or special function requires two currents to define it (except Jump, which requires only one). These currents are identified as the column current and the row current, corresponding to the column and row of the matrix. The column and row data is encoded by programming the plug-in units. Figure 3-15 shows a typical encoding scheme using resistors for a voltage-sensing amplifier plug-in unit. Notice that the 10 TS (time slot) pulses produced by the Time-Slot Counter stage are connected to the plug-in unit. However, time-slots 5, 6, and 10 are not used by the plug-in unit to encode data when using the Standard Readout Format (See Table 3-11 for Standard Readout Format). The amplitude of the time-slot pulse is exactly -15 volts as determined by the Timer stage. Therefore, the resultant output current from the plug-in units can be accurately controlled by the programming resistors in the plug-in units.

For example, in Figure 3-15 resistors R10 through R90 control the row analog data, which is connected back to the Readout System. Figure 3-16 shows an idealized output current waveform of row analog data resulting from the time-slot pulses. Each of the row-current levels shown in these waveforms correspond to 100 microamperes of current. The row numbers on the left-hand side of the waveform correspond to the rows in the Character Selection Matrix (see Fig. 3-20). The row analog data is connected back to the Readout System via terminal B37 of the plug-in interface.

The column analog data is defined by resistors R110 through R190. The program resistors are connected to the time-slot lines by switch closures to encode the desired data. The data, as encoded by the circuit shown in Figure 3-15, indicates a 100 microvolt sensitivity, with the CRT display showing inverted and calibrated deflection factors. This results in the idealized output current waveforms shown in Figure 3-16 at the column analog data output, terminal A37 of the plug-in interface.

Resistor R111, connected between time-slot 1 and the column analog data output, encodes two units of current dur-

Theory of Operation—7904A

ing time-slot 1. Referring to the Character Selection Matrix, Figure 3-20, two units of column current, along with the two units of row current encoded by resistor R10 (row 3), indicates that two zeros should be added to the display. Resistor R120 adds one unit of column current during time-slot 2 and, along with the one unit of current from the row output, the Readout System is instructed to add an invert arrow to the display. Resistor R130 is not connected to the time-slot 3 line, since the deflection factor is calibrated. Therefore, there is no display on the CRT during TS-3. (See Display-Skip Generator for further information).

During time-slot 4, two units of column current are encoded by R140. There is no row current encoded during this time-slot, resulting in the numeral 1 being displayed on the CRT. Neither row nor column analog data is encoded during time-slots 5, 6 and 7 as defined by the Standard Readout Format. During time-slot 8, two units of column current and three units of row current are encoded by resistors R181 and R80, respectively. This addresses the μ prefix in the Character Selection Matrix. The final data output is provided from time-slot 9 by R190 connected to the column output and R90 to the row output. These resistors encode two units of column current and four units of row current to cause a V (volts) symbol to be displayed. Time-slot 10 is not encoded, in accordance with the Standard Readout Format. The resultant CRT readout will be $100\mu\text{V}$.

In the above example, the row analog data was programmed to define which row of the Character Selection Matrix was addressed to obtain information in each time-slot. The column data changes to encode the applicable readout data as the operating conditions change. For example, if the variable control of the plug-in unit was activated, R130 would be connected between time-slot 3 and the column analog data output line. This encodes 10 units of column current (see shaded area in time-slot 3 of the waveform shown in Fig. 3-16). Since one unit of row current is also encoded during this time-slot by R30, a > (greater than) symbol is added to the display. The crt readout will now show > $100\mu\text{V}$. In a similar manner, the other switches can change the encoded data for the column output and thereby change the readout display. See the descriptions which follow for decoding this information.

The column analog data encoded by most plug-in units can be modified by attenuator probes connected to the input connectors of amplifier plug-in units. A special coding ring around the input connector of the plug-in unit senses the attenuation ratio of the probe (with readout-encoded probes only). The probe contains a circuit that provides additional column current. For example, if a 10X attenuator probe is connected to a plug-in unit encoded for 100 microvolts as shown in Figure 3-15, an additional unit of current is added to the column analog data during time-slot 1. Since two units of current were encoded by R111, this additional current results in a total of three units of column analog current

during this time-slot. Referring to the Character Selection Matrix, three units of column current, along with the two units of row current encoded by R10, indicates that the prefix should be shifted one column to the left. Since this instruction occurs in the same time-slot that previously indicated that two zeros should be added to the display and only one instruction can be encoded during a time-slot, the zeros do not appear in the display. The CRT readout will now be changed to 1mV (readout program produced by plug-in same as for previous example).

Three other lines of information are connected from the plug-in compartments to the Readout System. The column and row analog data from channel 2 of a dual-channel plug-in are connected to the Readout System through terminals A38 and B38 of the plug-in interface, respectively. Force readout information is encoded on terminal A35 and the function of this input is described under Column and Row Data Switches. The preceding information gave a typical example of encoding data from an amplifier plug-in unit. Specific encoding data and circuitry is shown in the individual plug-in unit manuals.

COLUMN AND ROW DATA SWITCHES

The encoding data from the plug-in units is connected to the Column and Row Data Switch stages. A column-data line and a row-data line convey analog data from each of the 8 data sources (2 channels from each of the 4 plug-in compartments).

The Column Data Switch U2190 and the Row Data Switch U2180 receive the Channel Address Code from the Channel Counter. This binary code directs the Column Data Switch and the Row Data Switch to the channel which should be the source of the encoding data. Table 3-13 gives the eight combinations of the Channel Address Code and the resultant channel selected with each combination. These stages have nine inputs and provide a time-multiplexed output at pin 7, which includes the information from all of the input channels. Eight of the nine inputs to each stage originate in the plug-in units and the ninth input to U2190 comes from a special data-encoding network composed of resistors R2191 through R2199. (See Zeros Logic and Memory description for further information on ninth channel).

In addition to the encoding data inputs from the plug-in units, inputs are provided to the Column Data Switch from the VERTICAL MODE and HORIZONTAL MODE switches to inhibit the readout for any plug-in unit(s) not selected for display. When a unit is not selected, the line corresponding to the opposite channel is HI to forward bias the associated diodes: CR2162 and CR2163, CR2166 and CR2167, CR2170 and CR2171, or CR2174 and CR2175. The forward-biased diodes cause the channel switches to bypass the encoded data from the inhibited channel. However, since

it may be desired to display information from special-purpose plug-in units (even though they do not produce a normal waveform display on the CRT), a feature is provided to over-ride the channel inhibit. This is done by applying a LO to the associated Force Readout input. The LO level diverts the HI channel-inhibit current and allows the data from this plug-in unit to reach the Column Data Switch, even though it has not been selected for display by the mode switch.

Row Match adjustment, R2183, sets the gain of the Row Data Switch to match the gain of the Row Decoder for correct output. Column Match adjustment, R2243 performs the same function for the Column Data Switch stage.

DISPLAY-SKIP GENERATOR

The Display-Skip Generator is made up of Q2223, Q2226, Q2227 and Q2229. This stage monitors the time-multiplexed column data at the output of the Column Data Switch during each time-slot to determine if the information is valid data that should result in a CRT display. Quiescently, about 100 microamperes of current flows through R2242 from Q2243 and the Zeros Logic and Memory stage. (The purpose of this quiescent current will be discussed in connection with the Zeros Logic and Memory stage). This current biases Q2223A so that its base is about 0.2 volt more positive than the base of Q2223B in the absence of column data. Therefore, since Q2223A and Q2223B are connected as a comparator, Q2223A will remain on unless its base is pulled more negative than the base of Q2223B.

The analog data output from the Column Data Switch produces a 0.5 volt (approximately) change for each unit of column current that has been encoded by the plug-in unit. Whenever any information appears at the output of the Column Data Switch, the base of Q2223A is pulled more negative than the base of Q2223B, resulting in a negative (LO) Display-Skip output to the Timer stage through Q2229. Recall that a LO was necessary at the skip input of the Timer so it could perform the complete sequence necessary to display a character.

Transistors Q2226 and Q2227 also provide Display-Skip action. The end-of-word level connected to their emitters is LO only during time-slot 1. This means they are enabled only during this time-slot. These transistors allow the Zeros Logic and Memory stage to generate a Display-Skip signal during time-slot 1 when information that is not to be displayed on the CRT has been stored in memory (further information is given under Zeros Logic and Memory).

COLUMN AND ROW DECODERS

The Column Decoder U2244 and Row Decoder U2185 sense the magnitude of the analog voltages at their inputs (pin 10) and produce a binary output on one of ten lines

corresponding to the column or row data encoded by the plug-in unit. These outputs provide the Column Digital Data and Row Digital Data, which is encoded by the Decimal-to-BCD converters to create the address used by the Character Generator in determining which character will be displayed. The column and row data is also used throughout the Readout System to perform other functions.

The input current at pin 9 of the Column Decoder stage is steered to only one of the ten Column Digital Data outputs. When a Display-Skip signal is present (collector of Q2229 HI), pin 9 is pulled HI through CR2229. This ensures that no current is connected to the Character Generator stage under this condition. Notice the corresponding input on the Row Decoder. This input is connected to ground and causes only one of the ten row outputs to saturate to ground.

The network at the input of the Row Decoder, made up of Q2181 and its associated components, is a Row-14 detector that produces the Jump Command. This row current is encoded by special-purpose plug-ins to cause all or part of a word to be jumped. Whenever row 14 (13 units of row current, or 1.3 millamperes) is encoded, the base of Q2181 pulled negative enough so that this transistor is forward biased to produce a LO Jump Command output at its emitter. The Jump Command is connected to the set input of RS flip-flop U2162B, whose reset input is connected to the Trigger Signal from pin 5 of the Timer. When the Jump Command and Trigger inputs are low, U2162B produces a LO output to reset the time-slot Counter as well as advancing the Horizontal Character Position Counter and the Channel Counter. U2162B also produces a HI output to signal Display Skip at pin 4 of the Timer.

ZEROS LOGIC AND MEMORY

The Zeros Logic and Memory stage U2232 stores data encoded by the plug-in units to provide zeros-adding and prefix-shifting logic for the Readout System. The Strobe pulse at pin 15 goes positive when the data has stabilized and can be inspected. This activates the Zeros Logic and Memory stage so that it can store the encoded data.

Typical output waveforms of the five possible input conditions that can occur are shown in Figure 3-17. When time-slot 1 occurs, a store command is given to all of the memories. If the plug-in units encoded data for column 1, 2, 3, 4, or 10 during time-slot 1, the appropriate memory (or memories) is set. Notice that row 3 information from the Row Decoder must also be present at pin 16 for data to be stored in the memory of U2232.

If data was encoded during time-slot 1, a negative-going output is produced at pin 7 while the memories are being set. This negative-going pulse is connected to the base of

Theory of Operation—7904A

Q2227 in the Display-Skip Generator to produce a Display-Skip output. Since the information encoded during time-slot 1 was only provided to set the memories and not intended to be displayed on the CRT at this time, the Display-Skip output prevents a readout display during this time-slot.

During time-slot 5, a memory within U2232 is interrogated. If information was stored in this memory, a positive-going output is produced at pin 7. This pulse is connected to pin 10 of the Column Decoder through Q2243 to add one unit of current at the input of the Column Decoder. This produces a zero after the character displayed during time-slot 4. During time-slot 6, another memory within U2232 is interrogated to see if another zero should be added. If another zero is necessary, a second positive output is produced at pin 7, which again results in a column 1 output from the Column Decoder and a second 0 in the CRT display.

Finally, another memory within U2232 is interrogated during time-slot 8 to determine whether the prefix should be changed, or left at the value that was encoded. If data has been encoded that calls for a shift in prefix, a negative-going output level is produced at pin 7. This negative level subtracts one unit of column current from the data at the input to the Column Decoder. Notice, on the Character Selection Matrix of Figure 3-20, that when row 4 is programmed, a reduction of one column results in a one-column shift of the prefix. For example, with the 100 μ V program shown in Figure 3-15. If the data received from the plug-in called for a shift in prefix, the CRT readout would be changed to 1mV (zeros deleted by program; see Encoding the Data).

The 100 microamperes of quiescent current through R2242 provided by Q2243 (see Display-Skip Generator) allows the prefix to be shifted from m (100 microamperes of column current, column 1) to no prefix (0 column current, column 0) so only the unit of measurement encoded during time-slot 9 is displayed. Notice that reducing the prefix program from column 1 to column 0 programs the Readout System to not display a character at this readout location.

A further feature of the Zeros Logic and Memory is the Identify function. If 10 units of column current are encoded by the plug-in unit along with row 3 during time-slot 1, the Zeros Logic and Memory produces a negative-going output pulse at pin 1 to switch the Column Data Switch and Row Data Switch to the ninth channel. Then, time-slot pulses 2 through 9 encode an output current through resistors R2191 through R2199 for column data and enable pin 10 of U2186. This provides the addresses necessary to display the word IDENTIFY in the word position allotted to the channel that originated the Identify command. After completion of this word, the Column Data Switch and Row Data Switch continue with the next word in the sequence.

The end-of-word signal from the Time-Slot Counter is connected to pin 9 of U2232 through C2239. At the end of each word of readout information, this pulse goes LO. This erases the four memories in the Zeros Logic and Memory in preparation for the data to be received from the next channel.

CHARACTER GENERATOR

Each character to be displayed on the instrument CRT consists of a series of connecting points developed on a possible 8-point by 8-point grid (see Fig. 3-22). The 8-bit binary output from the Character Generator is used to determine the location of points within the grid, whether or not to provide a trace connecting two points, and the point at which a character has been completed. The Character Generator stage consists of an oscillator, the Lower Order Address Generator, and an EPROM connected to a latch.

Q2151 and Q2152 form a square-wave oscillator whose frequency is adjustable with C2155 to provide 16 cycles within the time allotted for developing a character. The base of Q2152 goes LO when the Timer produces a negative going Ready pulse at pin 13. This starts the oscillator by turning Q2152 on. The emitter of Q2151 becomes more negative as C2154 and C2155 discharge through R2154. The capacitors continue to discharge until the emitter-base junction of Q2151 becomes forward biased. Q2151 then begins to conduct and causes the oscillator to begin changing states. As Q2151 conducts, the discharge through C2154 and C2155 stops and causes a collector current reduction in Q2152. The current reduction causes the emitter and base of Q2152 to rise positive which pulls the emitter of Q2151 along with them through C2154 and C2155. This positive shift on the emitter of Q2151 turns it off. Now with C2151 conducting and Q2152 turned off, the voltage on the emitter of Q2152 begins to go negative with C2154 and C2155 beginning to charge through R2155. When the emitter-base junction of Q2152 becomes forward biased, the oscillator again changes states and completes one cycle.

The signal produced by the oscillator at the collector of Q2152 switches Q2153 on and off to create the clock pulses used by the Lower Order Address Generator and the EPROM latch. The oscillator will continue to run until the Timer Ready output at pin 13 goes positive and pulls up the base of Q2152.

The Lower Order Address Generator is a 4-bit binary counter and consists of U2202B. The negative going Timer Ready pulse is inverted by Q2142 and used to reset U2202B. The oscillator is also enabled by the Ready signal and begins providing the clock input at pin 13. The counter then begins at 0000 and counts at the frequency of the oscillator, continuing to do so until the Ready signal goes posi-

tive. The Lower Order Address Generator's 4-bit output is connected to the four lower order address inputs on the Character Generator, U2203.

U2204 is an octal D-type flip-flop used as a latch to stabilize and synchronize the Character Generator EPROM output. It is reset by the same signal that starts the oscillator and is clocked at pin 11 by the oscillator output from Q2153. Q2204 will be considered to be part of the Character Generator in the discussion that follows.

The Character Generator U2203 is a 4k X 8-bit EPROM which contains the binary words used by the output stages in creating the signals necessary to form readout characters. There are twelve address inputs, with the lower four coming from the Lower Order Address Generator, the center four from the Column Decimal-to-BCD Converter, and the upper four from the Row Decimal-to-BCD Converter. As previously mentioned, each character is developed on an 8-point by 8-point grid (see Fig. 3-22 for a typical character). The Character Generator's 8-bit output provides the information necessary to move the instrument beam around within the grid, to turn the beam on and off, and to indicate when a character is complete.

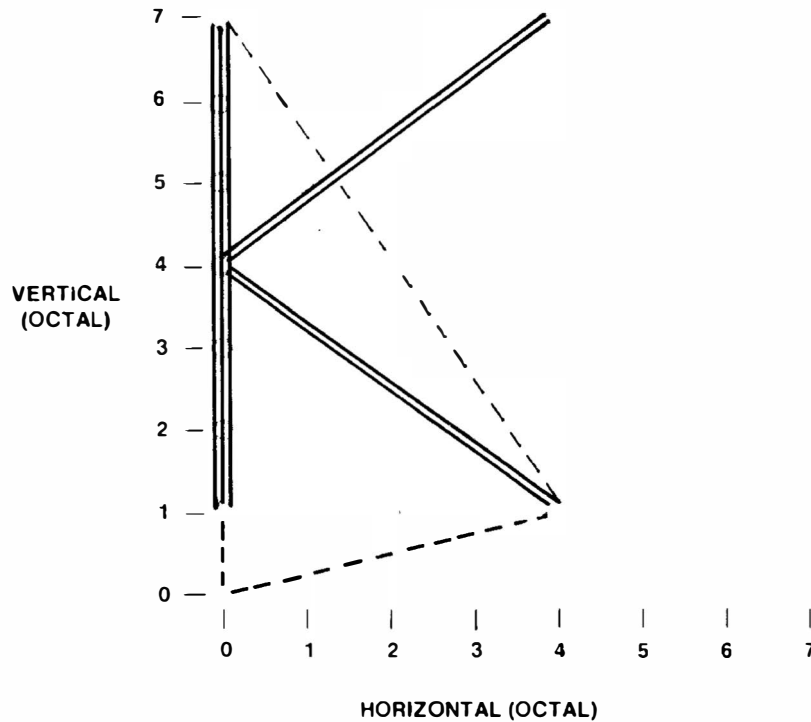

| "K" CHARACTER | | | | |
|---|----------------------------|-------|---------------------------------------|----------------------------|
| CHARACTER GENERATOR ADDRESS (HEXIDECIMAL) | CHARACTER GENERATOR OUTPUT | | BIT 7 MOVE - - - - DRAW - - - - | BIT 8 END OF CHARACTER? |
| | BINARY 8 7 6 5 4 3 2 1 | OCTAL | | |
| B 90 | 0 0 0 0 0 0 0 0 | 000 | MOVE | NO |
| B 91 | 0 0 0 0 1 0 0 0 | 010 | MOVE | NO |
| B 92 | 0 1 1 1 1 0 0 0 | 170 | DRAW | NO |
| B 93 | 0 1 0 0 1 0 0 0 | 110 | DRAW | NO |
| B 94 | 0 1 1 1 1 0 0 0 | 170 | DRAW | NO |
| B 95 | 0 0 0 0 1 1 1 0 | 014 | MOVE | NO |
| B 96 | 0 1 1 0 0 0 0 0 | 140 | DRAW | NO |
| B 97 | 0 1 1 1 1 1 1 0 | 174 | DRAW | NO |
| B 98 | 0 1 1 0 0 0 0 0 | 140 | DRAW | NO |
| B 99 | 0 1 0 0 1 1 1 0 | 114 | DRAW | NO |
| B 9 A | 1 0 0 0 0 0 0 0 | 200 | MOVE | YES |

Figure 3-22. Developing a typical character on the CRT (SN B031767 & Above).

Theory of Operation—7904A

The row and column data cause a 4-bit binary code to be generated at the outputs of the Row and Column Decimal-to-BCD Converters when a readout character is to be displayed. The Lower Order Address Generator is enabled and also provides a 4-bit binary code. These twelve bits are combined to form the EPROM address containing the 8-bit binary word which will locate the instrument beam at the character's starting grid location.

The 8-bit word can be broken down into four parts. The lower three bits are the horizontal grid coordinate, bits 4 through 6 are the vertical coordinate, bit 7 turns the Z Readout on and off, and bit 8 indicates whether or not the character is complete.

The character grid (Fig. 3-22) can be thought of as having vertical and horizontal coordinates numbered 0 through 7, with location "0,0" in the lower left corner. The 8-bit binary word from the Character Generator is converted to octal to easier recognize the vertical and horizontal coordinates. A binary "00001010" becomes octal "012". This number would cause the instrument CRT beam to point at grid coordinates vertical "1" and horizontal "2". The fact that the first octal digit is "0" indicates two things. First it shows that bit 7 of the binary word is LO which turns off Q2132 and the Z Readout signal to the instrument. It also shows that bit 8 is LO so the character is not complete. When bit 7 is HI, it advances the Horizontal Character Position Counter for the next character within the readout word.

The 4-bit outputs from the Row and Column Decimal-to-BCD Converters remain the same until the character is complete. However, the Lower Order Address Generator keeps counting and combines with the Row and Column Decimal-to-BCD Converter's outputs to address all the EPROM locations necessary to form the readout character.

Suppose the next address produces a Character Generator output of "01111010" or octal "172". The octal digit "1" indicates binary bit 7 is high which will turn on Q2132 and the Z Readout output to the instrument. The instrument will now provide a trace from the previous vertical and horizontal coordinates to the new ones, vertical "7" and horizontal "2". Thus the character is formed by a series of binary words causing the instrument CRT beam to move or draw between points.

HORIZONTAL CHARACTER POSITION COUNTER

The Horizontal Character Position Counter U2202A is a 4-bit binary counter. Its output is converted to current by R2266 through R2269 and added to the X (horizontal) signal for spacing readout characters horizontally on the CRT. The counter is reset to "0000" with a Word Trigger pulse from U2127B and is advanced with inputs from two possible

sources. The first is a HI End-of-Character signal from pin 19 of U2204. The counter can also be advanced when a Space instruction is encoded by the plug-in unit to cause a space to be left between two characters on the CRT. A Space instruction occurs when row 10 from the Row Decoder goes LO and is inverted by U2157D to advance the Horizontal Character Position Counter. No character could be displayed in this situation as no character information is stored at the Character Generator addresses formed using row 10.

Time slots 1, 2, and 3 are also connected to the Space instruction through VR2185, VR2186, and VR2187 respectively. This configuration adds a space to the displayed word during time slots 1, 2, and 3, even if information is not encoded during these time slots. With this feature, the information which is displayed during time-slot 4 (1-2-5 data) always starts in the fourth character position whether data has been displayed in the previous time-slots or not. Therefore, the resultant CRT display does not shift positions as normal/invert or cal/uncal information is encoded by the plug-in.

DECIMAL POSITION LOGIC

The Decimal Position Logic stage allows decimal points to be displayed at five possible locations within a readout word (see Fig. 3-18). The decimal location encoded by a plug-in during time-slot one is achieved by adding positioning current to the X (horizontal) readout signal. Circuitry for this stage includes five 2-input NOR gates in U2157 and U2251 with precision resistors connected to their outputs. One input of each NOR gate is connected to row 7 on the Row Decoder and the other to one of columns 3 through 7 on the Column Decoder. When a decimal is to be displayed, row 7 goes LO and disables the Horizontal Character Position Counter by keeping the four outputs of U2264 LO. It also sets one input of each of the five NOR gates to LO. One of columns 3 through 7 also goes LO, depending on which decimal position is encoded, causing the NOR gate to which it's connected to go HI. This high adds current to the X (horizontal) signal in the amount determined by the resistor connected to the NOR gate's output. Each Character Generator location addressed by row 7 and column 3 through 7 contains information necessary to form a decimal point on the CRT in the position indicated. The Horizontal Character Position Counter resumes normal operation and the Decimal Position Logic is disabled when row 7 goes back up at the end of the time-slot.

Some plug-ins require decimal points at locations in the readout word other than the five provided by the Decimal Position Logic stage. An additional decimal point can be displayed in any position normally available to characters by encoding row 8 with column 9. The Horizontal Character Position Counter provides positioning current in this mode and the Decimal Position Logic stage is disabled.

VECTOR GENERATORS

The Y Vector Generator is in two stages and consists of U2210A and B. Vertical character size adjustment is provided with R2210 as a variable feedback resistor for U2210A. Input to the Vector Generator is provided by the three bits of vertical character information from pins 9, 12, and 15 of the Character Generator latch U2204. The digital highs and lows across R2206, R2207 and R2208 are mixed as stepped current levels at pin 2 of U2210A. These sudden analog steps are converted into a smooth transition from one level to the next by RCL network R2212, C2212, and L2212. U2210B current buffers the resulting signal to be mixed with the Channel Counter vertical information at the input of the Y Output Amplifier.

The X Vector Generator operates similarly to the Y Vector Generator. Gain for the stage is fixed by the circuit components and its output is current buffered to be mixed at the input of the X Output Amplifier.

OUTPUT AMPLIFIERS

The Y Output Amplifier provides the Y (vertical) signal to the instrument by combining the signal from the Y Vector Generator with the channel 1 or 2 information from the Channel Counter. The amplifier consists of U2257B with Q2255 in its input circuit. Amplifier gain is adjustable with R2260 to control the vertical separation between readout words displayed at the top and bottom of the graticule area. Q2255 switches the amplifier input on and off with the Timer Ready signal, using Q2250 to provide impedance matching. The channel 1 or 2 information from pin 3 of the Channel Counter U2127A is inverted by U2251A and converted to current by R2252 and R2253. The Channel Counter produces a LO at pin 3 when the readout word is to be displayed at the top of the graticule. The LO is inverted to HI by U2251A and adds current to the Y (vertical) readout signal.

The X Output Amplifier consists of U2257A and Q2296. It operates similarly to the Y Output Amplifier to provide the X (horizontal) signal to the instrument. Input to the amplifier is a combination of outputs from the X Vector Generator, Horizontal Character Position Counter, Decimal Position Logic, and horizontal word position information from the Channel Counter. The gain of this stage is fixed by the resistor values in the circuit.



SIGNALS OUT & INTENSITY LIMITER

A schematic diagram of the Signals Out & Intensity Limiter is given on diagram 7, in Section 8 of this manual (Diagrams and Circuit Board Illustrations). The

schematic is divided by gray shaded lines separating the circuitry into major stages. These stages aid in locating components mentioned here. Sub-headings in the following discussion use the stage names to further identify portions of the circuitry on diagram 7.

The Signals Out circuit provides the + SAWTOOTH and + GATE signals to the front panel. These output signals are samples of signals from the associated time-base units.

+ SAWTOOTH AMPLIFIER

The sawtooth signals from the A and B time-base units are connected to the Sawtooth Amplifier stage through series resistors R93 and R95 respectively (see Diagram 3). The front-panel selector switch, S1940, determines whether the A-sweep or the B-sweep sawtooth signal provides the + SAWTOOTH signal. The unused sawtooth signal is terminated by R1941.

Transistors Q1943-Q1942-Q1946 form an inverting feedback amplifier. Gain of the stage is about 2, as determined by the ratio of feedback resistor R1944 to the input resistance (made up of R1940 and, on diagram 3, either R93 or R95 depending on which sawtooth source is selected).

+ GATE AMPLIFIER

The front-panel +GATE switch (S1930) selects the gate signal from either A or B time-base unit. The unused + gate is terminated in R1931. Before a gate occurs, Q1934 is biased off and Q1938 is conducting; its collector potential is low enough to cut off Q1928. When a gate occurs, it is coupled to the base of Q1934, causing it to conduct thereby cutting off Q1938. The current through R1911 now flows through Q1928 to produce the + GATE signal.

For certain applications, the Delay Gate output (J99, on the Main Interface board, diagram 3) may be connected to either of the gate inputs to the +Gate Amplifier. This provides a delay gate at the +GATE front-panel output.

END OF GATE PULSE GENERATOR

The End of Gate signal, at the collector of Q1934, is coupled through C1914 to the base of Q1916. This turns on Q1916, and generates a negative pulse which activates the Readout Single Shot, and Graticule Illumination stage when selected.

GRATICULE ILLUMINATION

Variable resistor R1900 (GRAT ILLUM) determines the brightness of the graticule lights (except when in the PULSED position) by controlling the output of the graticule light supply (see LV Regulators, diagram 15). Variable resistor R1902 (GRAT ILLUM PRESET)

determines the brightness of the graticule lights when the GRAT ILLUM control is set to PULSED. In the PULSED mode, the graticule lights are gated on for approximately 0.5 second. Programmable unijunction transistor Q1908, in conjunction with Q1910, generates the pulse to turn the graticule lights on. A negative signal (from the MAN pushbutton, the + Gate or from an external input) will cause Q1908 to conduct and start discharging C1908. At this time, Q1910 turns off, which allows R1902 to control the output of the graticule light supply. Capacitor C1908 discharges until Q1908 cannot maintain conduction. As Q1908 turns off, C1908 begins to charge positive until the zener voltage of CR1910 is reached which turns on Q1910; its collector then goes negative to turn the graticule light supply off. When in the PULSED mode and operating from the + GATE source, the graticule lights will turn on momentarily at the trailing edge of the + Gate (end of each sweep).

INTENSITY LIMITER

The Intensity limiter stage limits the crt screen current to approximately 4 microamperes to prevent burning the crt phosphor by long term on screen trace operation. This limiting occurs when the limit output of the Anode Multiplier, U21 (diagram 13) produces a negative shift of the DC current level. The DC current level is coupled to the inverting input of operational amplifier, U1952 and converted to a positive voltage at the noninverting input of Operational amplifier, U1958. This causes the output of U1958 to go positive which turns on emitter follower, Q1956, and produces a positive Intensity Reference output at TP1958. When the Intensity Reference goes positive, diodes CR2009, and CR2019 in the INTENSITY control circuit (diagram 2) will conduct to cause intensity limiting through the Z-AXIS Logic circuit (diagram 4), and the Auto Focus circuit (diagram 12).



VERTICAL CHANNEL SWITCH

The Vertical Channel Switch circuit selects the vertical deflection signal from the output of the LEFT and/or RIGHT VERT plug-in compartment(s) for display on the crt.

A schematic diagram of the Vertical Channel Switch is given on diagram 8, in Section 8 of this manual (Diagrams and Circuit Board Illustrations). The schematic is divided by gray shaded lines separating the circuitry into major stages. These stages aid in locating components mentioned here. Sub-headings in the following discussion use the stage names to further identify portions of the circuitry on diagram 8.

CHANNEL SWITCH

The vertical deflection signal from the left and right vertical plug-in units is either terminated within the stage or coupled through the stage, as determined by the Vertical Channel Selector stage. The Channel Switch stage is made up primarily of integrated circuit U668. Inputs 7 and 9 provide a differential input for the signal from the right vertical plug-in unit. Input pins 17 and 19 provide a differential input for the signal from the left vertical plug-in unit. The differential output signal at pins 3 and 13 is connected to J694 and J592 respectively.

Components U682, Q682, Q676, and Q672 supply standing current to U668 and maintain the output common-mode dc level at +8.5 volts for all Channel Switch modes. The common-mode level at pins 3 and 13 of U668 is sensed by R559-R659, and compared with a reference level determined by divider R680-R681. Assume for example that pin 2 of U682 is lower than pin 3, indicating an output level below 8.5 volts. The output of U682 at pin 6 will be driven positive and current will flow in R683. This current must be supplied from the +15 V supply via R682, thereby lowering the base voltage of Q682. This increases the collector current in Q682. Transistor Q676 operates as a common-base amplifier and passes along the increased collector current to pin 3a of U668. This increases the output common-mode level thus bringing U682 into balance. The voltage at pin 3a of U668 depends on the Channel Switch mode: in LEFT, RIGHT, ALT, or CHOP pin 3a is at +10.5V; in ADD it is +12.5 V; when X-Y Inhibit is HI, pin 3a is +8.5 volts. In all modes the current supplied by Q676 is 160 milliamperes plus or minus small variations required to keep the output level at +8.5 volts.

VERTICAL CHANNEL SELECTOR

The Vertical Channel Selector interfaces the Channel Switch, U668, to the logic signals arriving from the Main Interface. The Channel Switch stage requires two pairs of complementing control voltages; one pair for each channel. The HI control voltage is +4.0 V, the complementing LO voltage is +3.5 V. To select a channel, the HI level must be applied to the On input of U668 (pin 2 for LEFT, and pin 12 for RIGHT VERTICAL MODE switch positions) and the LO level must appear at the OFF input (pin 1 for LEFT, and pin 11 for RIGHT VERTICAL MODE switch positions). To inhibit a channel the control voltages should be reversed.

When the VERTICAL MODE switch is set to LEFT the Display Right line, entering on P680 pin 6, is set LO (-0.6 V), the Add line (P680 pin 5) is LO (0 V) and, normally, X-Y Inhibit is LO (-0.6 V). Transistors Q652, Q658 and Q558 are turned on; Q656 and Q556 are off. The result is pins 1 and 12 of U668 are pulled down to +3.5 V but pins 2 and 11 are only pulled down to +4.0 V. Consequently, the LEFT VERT channel is turned on while the RIGHT VERT channel is turned off. Signals



VERTICAL AMPLIFIER

appearing at J602 and J603 are amplified and fed to the outputs at J592 and J694. Similarly, if Display Right is HI (+1 V), the RIGHT VERT channel is turned on and LEFT VERT channel off. RIGHT VERT channel signals are amplified and fed to the outputs. LEFT VERT channel signals are terminated within U668.

When the VERTICAL MODE switch is set to either ALT or CHOP, the Display Right signal line switches between the LO and HI levels at a rate determined by either the Chop Counter or Vertical Binary stages (see Logic description diagram 4). This action displays the signal from the left vertical unit when the Display Right signal line is LO and displays the signal from the right vertical unit when the signal line is HI.

When ADD vertical mode operation is selected, the Add signal line is HI, and the Display Right Signal is LO. This allows both the right and left vertical signals to pass to the output of U668. The signals from both vertical units are algebraically added and the resultant signal determines the vertical deflection. The X-Y Inhibit command has absolute control over the output of the Channel Switch stage. Quiescently, this signal is LO; however, when the Readout System is ready to display information on the crt, this level goes HI, blocking the signals from both vertical units.

When X-Y Inhibit is HI (+1 V) Q652 is turned off. Current in R653 now flows through CR552 and CR654 lowering the base voltage of Q556 by one diode drop, and that of Q658 by two diode drops. This insures that Q558 and Q656 are turned on regardless of the state of Display Right or Add.

RIGHT AND LEFT CHANNEL FEEDBESIDE

The operation of the Left and Right Channel Feedbeside stages are identical. Therefore, only a discussion of the Right Channel Feedbeside is given.

The function of the Feedbeside stage is to compensate for low-frequency imperfections in the frequency response of the Channel Switch stage, U668. Self heating of the transistor base-emitter junction, in some transistors within U668, causes the low-frequency gain to appear larger than the midband gain. To correct this, a portion of the input signal is picked off through R502 and R504 and applied to U508. This differential signal is converted to a single-ended signal and distributed into four RC (resistive-capacitive) networks, each having a different time constant. Variable Components R512, R515, R520, R525, R530, and C538 are adjusted to provide an accumulated waveform. This waveform is converted to a paraphase signal by U538, Q542 and Q548, and is then injected into U668 through Pins 6 and 4, where it is subtracted from the signal entering U668 at pins 7 and 9. Proper adjustment results in flat-frequency response and optimum-transient response at the output pins 3 and 13.

A schematic diagram of the Vertical Amplifier is given on Diagram 9, in Section 8 of this manual (Diagrams and Circuit Board Illustrations). The schematic is divided by gray shaded lines separating the circuitry into major stages. These stages aid in locating components mentioned here. Sub-headings in the following discussion use the stage names to further identify portions of the circuitry on diagram 9.

The Vertical Amplifier circuit provides final amplification for the vertical signal received from delay-line DL5 before it is applied to the crt vertical deflector. In addition, low-frequency signals to provide the VERT TRACE SEPARATION (B) function and crt scale factor readout are accepted at the Aux Y-Axis and Y Readout inputs, respectively. The vertical portion of the BEAMFINDER function is also handled in the Vertical Amplifier.

DELAY-LINE

Delay-line DL5 delays the vertical signal approximately 65 nanoseconds to allow the horizontal circuits time to initiate a sweep before the vertical signal reaches the crt vertical deflection plates. This allows the instrument to display the leading edge of the signal originating the trigger pulse when using internal triggering. The delay-line impedance is 100 ohms differentially, and because it is coaxial does not produce preshoot or phase distortion in the crt display.

DELAY-LINE COMPENSATION

The Delay-Line compensation stage provides frequency compensation to offset delay line losses due to "skin-effect" in the cable. This compensation is achieved by attenuating the signal at low frequencies approximately 4.8 dB. At high frequencies (about 1.0 gigahertz) the signal passes with little attenuation. Transient response front-corner adjustment is achieved by C215 and R215. The components connecting the input signal to U415 provide forward termination of the delay-line.

FEEDBESIDE

The function of the Feedbeside stage is to compensate for low-frequency imperfections in the frequency response of the Output Amplifier stage, U415 and U515. Self heating of the transistor base-emitter junction, in some transistors within U415 and U515, cause the low-frequency gain to appear larger than the midband gain. To correct this, a portion of the input signal is picked off via the Delay Line Compensation stage and applied to U335. The paraphase signal is converted to a single-ended signal by U335 and distributed into six RC (resistive-capacitive) networks, each having a different time constant. Resistors R130, R131, R132, R237, R335,

Theory of Operation—7904A

R238, and C200 are adjusted to provide an accumulated waveform. This waveform is converted to a paraphase signal by U100, Q400, and Q303, and is then injected into U415 through Pins 1 and 5, where it is subtracted from the signal entering U415 at pins 7 and 9. Proper adjustment of the seven RC components results in a flat-frequency response and optimum-transient response at the output of U415 (pins 17 and 19.)

Diodes CR334 and CR333 improve the vertical amplifier overdrive recovery by limiting the amplitude of the feedbeside correction signals that exceed the dynamic range of the Output Amplifier. Thermistor RT303 adjusts the gain of the feedbeside amplifier to provide increased correction at high ambient temperature where transistor self-heating is aggravated.

OUTPUT AMPLIFIER

The output amplifier consists of 2 thin-film Hybrid wideband amplifiers, U415 and U515, and their associated bias circuitry. These amplifiers provide a voltage gain of 4 and 10 respectively resulting in an overall voltage gain, from J10 and J9 to the crt vertical deflector, of about 40. All signal path interconnections between and within hybrids are made with 50 ohm strip transmission lines via the HYPCON system.

Integrated circuit U415 receives the delayed and compensated signal from the delay-line compensation stage at input pins 7 and 9. Variable resistor R211 provides vertical amplifier gain adjust by shunting the differential signal. Trimmers C401, R405 and R404 are transient response adjustments, effective in the first 10 nanoseconds of the step response. Bias current for U415 is supplied by U700B. U700A and associated circuitry operate as a power supply to maintain a constant common-mode dc level at the input to U515 regardless of current demand from U415.

The BEAMFINDER switch, when depressed, changes the current source for U515 to provide the BEAMFINDER function. Normally, the current source for U515 is supplied from the +15 V supply through Q422 (diagram 10). However, when the BEAMFINDER switch is actuated, Q422 is turned off, so the only current source for U515 is through R712. This limits the dynamic range of the stage by limiting its available current, so the display is compressed vertically within the crt graticule area.

The signal at the output of U515 (pins 17 and 19) is connected, via a flexible coplanar transmission line, to the crt vertical deflection plate neck pins. A distributed deflection plate system is used in the crt for maximum bandwidth. The signal travels along the deflectors at a velocity essentially the same as the velocity of the electron beam passing through the vertical deflector. This synchronism of the deflection signal and the electron beam reduces the loss in high-frequency sensitivity due to electron-transit time through the

deflection plate structure. After propagating along the deflection plates the signal exits the crt into a termination network consisting of R83. R83 is adjustable to match the crt impedance deflection structure to the crt termination.

OUTPUT PROTECTION

Transistors Q722 and Q720 comprise a protection circuit for U515, in case the +15 volt supply is shorted to ground. If this occurs, Q722 turns on causing the base of Q720 to drop below +35 volts. Thus, the emitter voltage of Q720 is kept at a safe level for U515.

AUXILIARY AMPLIFIER

The Auxiliary Amplifier is used to inject low-frequency (≤ 2 MHz) signals, associated with crt scale-factor readout and alternate sweep switching, into the vertical deflection system. Normally, the X-Y Inhibit signal entering at J26 is LO (-0.6 V), Q541 and Q630 are off, and Q631 is on. The Aux Y-Axis signal ("trace separation") at J43 is coupled through Q631 to the input of paraphase amplifier Q530 and Q435. Transistors Q431 and Q430 form a shunt-feedback amplifier with sufficient gain to drive the inputs of U415 (pins 7 and 9).

When the Readout system initiates a character display it sets the X-Y Inhibit logic level HI (+1 V). Emitter follower Q540 turns Q541 on. The voltage on the collector of Q541 drops to zero which turns Q631 off and turns Q630 on. The Aux Y-Axis signal is then blocked by Q631. Y Readout signals are inverted by U630. Readout centering is added to the composite readout signal and then applied to the input of the paraphase amplifier via Q630. At the end of the character display period X-Y Inhibit returns to -0.6 V.



HORIZONTAL INTERFACE

A schematic diagram of the Horizontal Channel Switch is given on diagram 10, in Section 8 of this manual (Diagrams and Circuit Board Illustrations). The schematic is divided by a gray shaded line separating the circuitry into major stages. These stages aid in locating components mentioned here. Sub-headings in the following discussion use the stage names to further identify portions of the circuitry on diagram 10.

The Horizontal Channel Switch circuit determines whether the signal from the output of the A horizontal or B horizontal plug-in unit provides the horizontal deflection signal. This circuit also accepts an input from the Readout System (diagram 6) which blocks the horizontal signal while the readout display is presented on the crt.

CHANNEL SWITCH

The Channel Switch stage consists primarily of U518. The differential horizontal signal from the A HORIZ plug-in compartment is applied to pins 2 and 15. The differential horizontal signal from the B HORIZ plug-in compartment is applied to pins 10 and 7. The Display B control signal determines whether the A or B horizontal signal is coupled to the output pins 12 and 13.

When the Display B control signal at pin 4 of U518 is HI, the signal from the B plug-in is coupled to the output. When the Display B control signal is LO, the signal from the A plug-in is coupled to the output.

When the X-Y Inhibit command at pin 6 of U518 is LO, signals from the horizontal plug-ins may be transferred to U518 output as just described. If the X-Y Inhibit command is HI, U518 is disabled, and no signals may be transferred through the device.

X-Y DELAY COMPENSATION (OPTION 2)

The X-Y Delay Compensation network is an optional feature. For instruments not equipped with this option, the horizontal signals from the plug-in units are connected directly to the Horizontal Channel Switch through the Horizontal Interconnect board. When installed, the X-Y Delay Compensation network provides delay for the horizontal signals from the A and B HORIZ plug-in compartments to match the delay of the vertical signal produced by the vertical Delay-Line (diagram 9).

The delay compensation network is actually two separate delay networks, an A network, and a B. The B delay compensation network may or may not be activated, depending on the type of plug-in in the B HORIZ compartment. Operation of the A delay compensation network is achieved by S801, the delay disable switch, located on the X-Y Delay Compensation board. This switch is normally in the out position which keeps the A delay Compensation network disabled, and allows the A HORIZ signal to pass directly to the channel switch input. When switched to the IN position, S801 connects one side of relays K802, K805 to ground. This activates the relays, and the A HORIZ signal now passes through the delay compensation network.

The delay disable switches, S801, S811, allow for selection of a display with either minimum phase-shift characteristics or optimum step response. In the OUT position, the delay compensation network is bypassed for optimum step response.

The Delay Compensation network provides flat time delay with frequency. LC network L806, C806, L807, C807, L808, C808, L809, C809 is an all-pass lattice network with a 100 ohm input impedance when terminated in 100 ohms (50 ohms each side). Low-pass network L802, R802, C803, C804, L805, R805 also has a 100 ohm input impedance when terminated into 100

ohms. Only the low-pass network determines the bandwidth of the delay compensation network. The total time delay is the sum of the low-pass and all-pass network time delays. Capacitor C804 is adjusted to match the horizontal system time delay to the vertical system time delay, up to at least one megahertz.

Time-Base Operation

When the plug-in unit installed in the B HORIZ compartment is operated as a standard time-base unit, to produce a horizontal sweep, the B delay compensation network is disabled. In this condition, the X-Y compensation command is HI, which disables relays K812 and K815. Therefore, the horizontal signal passes undelayed to the Horizontal Channel switch.

X-Y Operation

If the time-base unit installed in the B HORIZ compartment is operated as an amplifier, or if an amplifier unit is installed in the B HORIZ compartment, the X-Y compensation command to the B delay compensation network drops to the LO level (zero volts). This activates relays K812 and K815 to connect the delay compensation into the circuit.



HORIZONTAL AMPLIFIER

The Horizontal Amplifier circuit amplifies the push-pull horizontal deflection signal from the plug-in unit installed in either horizontal compartment and connects it to the horizontal deflection plates of the crt.

A schematic diagram of the Horizontal Amplifier is given on diagram 11, in Section 8 of this manual (Diagrams and Circuit Board Illustrations). The schematic is divided by a gray shaded line separating the circuitry into major stages. These stages aid in locating components mentioned here. Sub-headings in the following discussion use the stage names to further identify portions of the circuitry on diagram 11.

INPUT AMPLIFIER

The Input Amplifier stage consists of an FT doubler, Beamfinder and readout positioning circuitry. Two differential pairs of transistors, Q320, Q321 and Q330, Q340, plus two common base amplifiers comprise the FT doubler. The signal from the Horizontal Channel Switch is connected to the bases of Q320 and Q340. The gain of this input stage is controlled by the emitter resistors of the differential pairs. Overall gain is set by the Horizontal Gain adjustment R230. High frequency adjustments are also provided in the differential pair emitters. Horizontal centering adjustment R121 balances the base currents of Q320 and Q340 to horizontally center the display.

Theory of Operation—7904A

The emitter current for the differential pairs is normally supplied from +15 volts through Q400 (diagram 10). However, when the front-panel BEAMFINDER switch is pressed, Q400 turns off, and R530 must now supply the emitter current. This results in less emitter current which reduces the dynamic range of the differential pairs to keep the horizontal display confined to the screen. Also, the current now flowing in R530 pulls the base of Q410 negative, turning the transistor on. The bias currents for Q620 and Q640 bases are maintained by the current through Q410 at nearly the normal level even though the emitter current of the differential pairs is reduced.

When readout is displayed, the X Readout signal is applied to the Horizontal Amplifier through J12. At the same time, the X-Y Inhibit signal causes Q140 to turn on, enabling the Readout Centering adjustment R114. The readout display may now be horizontally positioned.

DRIVER AMPLIFIERS AND ACTIVE PEAKING

The left and right Driver Amplifiers each consist of a single inverting transistor stage followed immediately by an Active Peaking network. Transistors Q620 and Q640 make up the right and left Driver Amplifier stages respectively. Both act as shunting feedback amplifiers, converting current signals at their bases to low impedance voltage signals at their collectors.

The Active Peaking networks are composed of Q621, Q630, and related components. Because operation of left and right Active Peaking circuits is identical, only a discussion of the right Active Peaking circuit follows. The signal at the collector of right Driver Amplifier, Q620 is coupled through R722 to the bases of Q810, Q820 of the right output Amplifier stage, and to the base of Q621 of the right Active Peaking circuit. Transistor Q621 is connected as an emitter follower, providing current gain which is coupled through R722, C810 and C811 to the input of the right Output Amplifier. This signal current, differentiated by C810 and C811, is added to the dc-coupled signal current passing through R722, providing the current necessary to charge the feedback capacitor C911, when a fast transition occurs. The amount of differentiated signal current added to the dc signal may be adjusted by C810 to obtain best signal response.

OUTPUT AMPLIFIER

The Output Amplifier stage consists of two current driven feedback amplifiers: the right and left Output Amplifiers. Because operation of the two amplifiers is identical, a discussion of only the right Output Amplifier follows. The input to the right Output Amplifier is at the junction of the bases of the transistor pair Q810, Q820. The output of this stage is the junction of the collectors of Q910, Q920. Components R920, C911 comprise the feedback loop. Signals at the bases of Q810, Q820 are amplified and inverted. Low-frequency signals pass

through Q910, while high-frequency signals pass through Q920. Both Q910 and Q920 are common-base amplifiers, connected in a complimentary configuration to provide less resistive loading for driving the right (+) horizontal crt deflection plate.

Zener diode VR950, located between input and output transistors of the left Output Amplifier, maintains proper operating voltages within the input and output circuits. Limit Center adjustment, R630 provides a variable current to both left and right Output Amplifiers to more closely balance their operation.

Thermal sensing amplifier Q830 ensures proper current flow in R734 when ambient temperatures change. It also balances out quiescent voltage level differences between the left and right Output Amplifiers due to the different polarity of the transistor pairs.



Z-AXIS AND FOCUS AMPLIFIER

A schematic diagram of the Z-Axis and Focus Amplifier is given on diagram 12, in Section 8 of this manual (Diagrams and Circuit Board Illustrations). The schematic is divided by gray shaded lines separating the circuitry into major stages. These stages aid in locating components mentioned here. Sub-headings in the following discussion use the stage names to further identify portions of the circuitry on diagram 12.

Z-AXIS AMPLIFIER

The Z-Axis Amplifier provides the drive signal to control the crt intensity level through the control-grid DC Restorer stage of the High Voltage circuit (diagram 13). The Z-Axis Amplifier receives two input signals: the Z-Axis signal which controls the trace intensity, and the Z-Readout signal which controls the readout intensity. Both signals are fed through common-base amplifier Q113 to establish low input impedance. Transistors Q122 and Q132 comprise a single-ended paraphase amplifier that, along with Output level adjustment R135, and Z-Axis Amplifier Gain adjustment R125, controls the operating current of this input stage. The signal from the output of Q122 is inverted by Q127 and applied to the base of emitter follower Q143, where it is dc-coupled to the bases of Q167, Q166 through resistor R166 of the output stage.

The output stage is comprised of three networks: a pulse-shaping network, a current-boost network, and an operational amplifier. The pulse-shaping network, comprised of transistor pair Q167, Q166, constant-current source Q162, and adjustable components C150, R150, R155, C155 and C180, provides compensation to achieve a fast-rising output pulse with optimum square

corner. The current-boost network, comprised of common-base amplifier Q173, and resistors R169, R176 and R177, provides a fast current path for the increased current needed to drive the DC-Restorer network and the control grid of the crt. The operational amplifier, comprised of Q184, Q183, and feedback components R179, C179, maintains the output level of the Z-Axis Amplifier during quiescent operation.

AUTO-FOCUS CHANNEL SWITCH AND AMPLIFIER

The Auto-Focus Channel Switch and Amplifier stages provide control voltages to maintain optimum focus of the crt display. When the front-panel FOCUS control is set for best definition of the crt display (at low to medium settings of the INTENSITY controls), these stages maintain optimum focus for all portions of the display as it is switched between the A and B Horizontal displays.

Transistors Q36, Q32, Q39, and Q50 act as a current driven data switch that provides the correct input to the base of Q67 of the amplifier stage. This switch selects either the A Intensity, B Intensity or Readout Intensity input as determined by the X-Y Inhibit and Display B commands. The input/output table in Table 3-14 shows the output of the channel switch stage applied to the base of Q67 for each combination of the input conditions.

The Auto-Focus Amplifier is a noninverting operational amplifier consisting of an input comparator, Q67, Q68 and an output complementary amplifier Q 77, Q83. Signals out of the data switch are shaped by resistors R63, R62, R64, R65 and diodes CR64 and CR65. Focus Gain adjustment R63 determines the amount of signal to the base of Q67 to set the overall gain of the amplifier stage. Signals applied at the base of Q67 are compared with the voltage at the base of Q68 as set by the Focus Output Level adjustment, R70. The compared signal is

TABLE 3-14
Input/Output Relationships for the
Auto-Focus Channel Switch

| X-Y INHIBIT COMMAND | DISPLAY B COMMAND | DATA OUT |
|------------------------|----------------------|-------------------|
| HI | Φ | READOUT INTENSITY |
| LO | LO | A INTENSITY |
| LO | HI | B INTENSITY |

Φ = HAS NO EFFECT IN THIS CASE

then coupled into the bases of Q77 and Q83. Transistor Q77 normally sets the focus-grid voltage. However, when Q83 conducts due to a change in intensity coupled through the data switch, the focus-grid voltage changes. The output of Q77, Q83 is fed back into the base of Q68 to return the transistor to the normally on condition.



**HIGH-VOLTAGE POWER SUPPLY
AND CRT**

The High-Voltage Power Supply and CRT circuits provide the potentials necessary for proper operation of the crt (cathode-ray tube). These circuits, in conjunction with the Vertical, Horizontal, Z-Axis and Auto-Focus Amplifiers, provide all quiescent potentials and signal information necessary for a properly displayed crt trace. The schematic diagram of the High-Voltage Power Supply and CRT circuits is given on diagram 13, in Section 8, Diagrams and Circuit Board Illustrations. The schematic is divided by gray shaded lines separating the circuitry into major stages. Sub-headings in the following discussion use these stage names to aid in locating and identifying the components and portions of the circuitry described.

POWER TRANSFORMER

The Power Transformer T14 is driven by a 25 KHz square-wave voltage from the Converter/Rectifiers circuit (secondary of Low-Voltage Transformer, T110, on diagram 14). Three secondary windings on T14 provide power for the +130 V Supply, CRT Heater voltage, Anode Voltage Multiplier, and the CRT Cathode supply. The square-wave output of T14 also drives the Control-Grid DC Restorer and the Focus-Grid DC Restorer stages through the resistor pairs R61-R62 and R31-R32 respectively. The Fault Sense output, referenced to ground in the transformer secondary through CR17, CR18, CR19, is connected to the Inverter control circuit (diagram 14).

+130 V SUPPLY

The +130 V Supply provides a semi-regulated voltage for use in several circuits in the 7904A. Semi-regulation is achieved by the Inverter Control stage of the Converter/Rectifiers circuit, diagram 14. Diodes CR101 and CR102 rectify the voltage from the secondary of T14. Capacitors C103, C104 and R104 filter the rectified voltage.

CRT HEATER

The CRT Heater voltage is provided by a separate 6.3-volt secondary winding of T14. The CRT Heater circuit is elevated to the cathode potential through R93.

ANODE VOLTAGE MULTIPLIER

Positive accelerating potential for the crt anode is supplied by the seven-times voltage multiplier contained within U21. The applied voltage to the input of U21, from the secondary of T14, is about three kilovolts peak-to-peak. This results in an output voltage of about +21 kilovolts at the crt anode. The limit output of U21 provides a dc-level to the Intensity Limit circuit (diagram 7).

CRT CATHODE SUPPLY

The negative three-kilovolt (-2965 V) accelerating potential for the crt cathode is generated by a voltage doubler consisting of CR83, CR82, C82 and C84. High frequency filtering is accomplished by R84, C86, R86 and C89. Components R86 and C89 also provide an ac-coupling path for error correction from the Cathode Supply Regulator stage.

CATHODE SUPPLY REGULATOR

The Cathode Supply Regulator maintains the potential on the crt cathode and reduces ac ripple from the CRT Cathode Supply. A sample of the output from the CRT Cathode Supply stage is connected to the Cathode Supply Regulator stage through divider resistors R52A, R116 and R115. High-frequency changes from the CRT Cathode Supply are coupled to the Cathode Supply Regulator through C119 and R119.

The Cathode Supply Regulator consists of a noninverting preamplifier U123 and an inverting output amplifier, Q129. The +50 volt supply connected to pin 3 of U123 (through HV ADJ, R115) in conjunction with the ground connected to pin 2 of U123 through R122, provide the reference for error amplifier U123. Transistor Q129 is connected as an inverting amplifier driven by U123 to provide error correction to the crt cathode supply.

Regulation occurs as follows: If the crt cathode voltage becomes less negative, a positive-going change is coupled to the input of U123 at pin 3 and results in a positive-going output at pin 6. This positive-going change is inverted by Q129 to a negative-going change at its collector. This causes the voltage across C82 to increase during the positive half cycle of the input waveform. During the negative half cycle, the increased voltage across C82 increases the voltage at the output of the CRT Cathode Supply to correct the original error. High-frequency correction signals are ac coupled to the crt cathode through C89.

CONTROL-GRID DC RESTORER

The Control-Grid DC Restorer stage elevates the dc level of the Z-Axis Amplifier output to a potential more negative than the crt cathode. This action allows the control grid to control the crt beam current. The Control-Grid DC Restorer stage is driven by the square-wave output of T14 pin 9. Diodes CR64 and CR63 are

forward biased during the positive and negative half cycles of the input square wave, respectively, to limit the square-wave amplitude at their junction. Grid Bias adjustment, R65, sets the voltage on the cathode of CR64 to establish the forward-bias level and peak positive level at the anode of CR64. The dc level of the Z-Axis Amplifier output determines the voltage on the anode of CR63, which establishes the forward-bias level and peak negative level at the cathode of CR63. The limited-amplitude square wave at the junction of CR64 and CR63 is coupled to the junction of CR67 and CR68 through C66. During the positive half cycle, CR67 is forward biased to clamp its anode at the crt cathode voltage level. During the negative half cycle, C69 is charged through CR68 to a voltage level more negative than the crt cathode. The amount of charge is equal to the difference between the Grid Bias adjustment setting and the Z-Axis Amplifier output level. High-frequency Z-Axis Amplifier signals are coupled to the control grid through C72, R72, R63 and C69.

FOCUS-GRID DC RESTORER

The operation of the Focus-Grid DC Restorer is similar to the operation of the Control-Grid DC Restorer. The limited-amplitude square wave at the junction of CR34 and CR33 is coupled to the junction of CR38 and CR37 through C36. The amplitude of the positive half cycle of the input square wave is clamped at approximately +130 volts by CR34. The peak negative amplitude is established by the dc level of the Auto-Focus Channel Switch and Amplifier output (diagram 12) through CR33. During the positive half cycle, the focus grid voltage is clamped to the voltage set by the FOCUS control R2005 (diagram 2) and Focus Preset R55 through R37, CR37 and CR38. During the negative half cycle, C39 charges through CR38 to establish the proper level at the focus grid electrode.

CRT CONTROL

The ASTIG adjustment, R2025 (diagram 2), used in conjunction with the FOCUS control R2005 (diagram 2) to obtain a well-defined display, varies the voltage level on the astigmatism grid. The SHIELD VOLTS adjustment, R155, varies the positive potential on the grid shielding the vertical deflection plates from stray voltages existing within and near the crt. GEOM adjustment, R143, varies the positive level on the horizontal deflection plate shield to control the overall geometry of the display.

Two adjustments control the trace alignment by varying the magnetic field around the crt. The Y-AXIS ALIGN adjustment, R122 (diagram 10) controls the current through L22, which affects the crt beam after vertical deflection but before horizontal deflection. Therefore, it affects only the vertical (Y) components of the display. The TRACE ROTATION adjustment, R2035 (diagram 2), controls the current through L21 and affects both the vertical and horizontal rotation of the beam.

14

CONVERTER/RECTIFIERS

The Converter/Rectifiers circuit provides the operating power for this instrument from an ac line-voltage source. This circuit includes a LINE VOLTAGE SELECTOR switch located on the rear panel. Figure 3-20 shows a detailed block of the Converter/Rectifiers circuit. A schematic diagram of the Converter/Rectifiers is given on diagram 14, in Section 8, Diagrams and Circuit Board Illustrations. The schematic is divided by gray shaded lines separating the circuitry into major stages. These stage names aid in locating and identifying the components and portions of circuitry mentioned here.

LINE INPUT

Power is applied through line filter FL10, line fuse F10 and POWER switch S10. The line filter is designed to

keep powerline interference from entering the instrument, and to keep the approximate 25-kilohertz Inverter signal from entering the power line. Components R5, C5 and C6 suppress reverse-recovery transients of CR15.

The LINE VOLTAGE SELECTOR switch, S12, allows the instrument to operate from either a 115 volt nominal or a 230 volt nominal line voltage source. In the 115 volt position, rectifier CR15 operates as a full-wave doubler with energy-storage capacitors C16 and C17, so the voltage across the two capacitors in series will be the approximate peak-to-peak value of the line voltage. For 230 volt operation, CR15 is connected as a bridge rectifier, and the voltage across C16 and C17 will be the approximate peak value of the line voltage. Thus, the dc voltage applied to the Inverter stage is about the same for either 115 or 230 volt operation.

Thermistors RT9 and RT13 limit the surge current when the power supply is first turned on. After the instrument

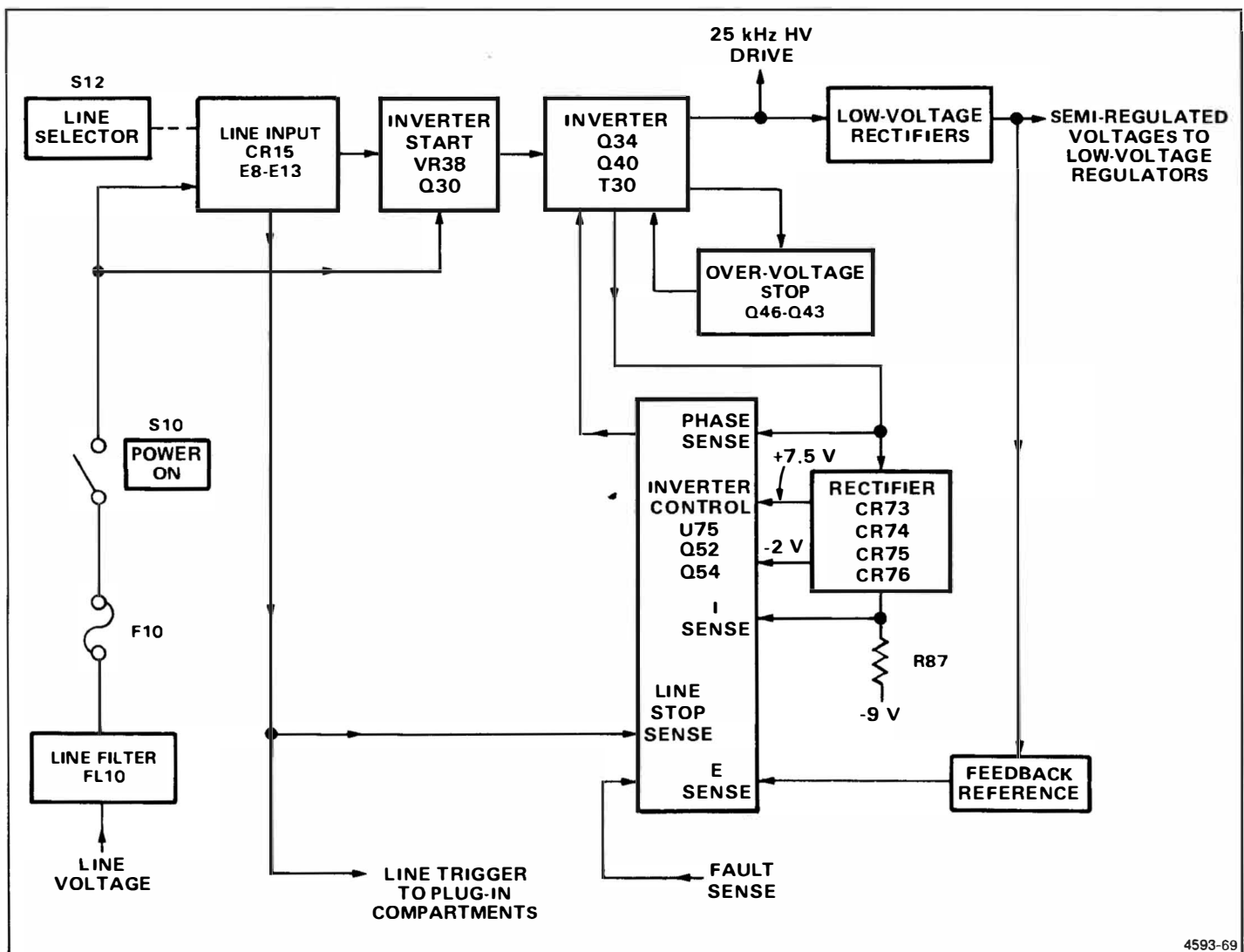

Figure 3-23. Detailed block diagram of the Converter/Rectifiers circuit.

4593-69

Theory of Operation—7904A

is in operation, the resistance of the thermistors decreases so that they have little effect on the circuit. When the instrument is turned off, the Inverter Control stage turns off the Inverter, which prevents it from discharging C16 and C17; C16 and C17 discharge slowly through R21 to allow for[†] thermistor thermal-recovery time. This ensures sufficient thermistor resistance to limit the turn-on surge current to a safe level. Since C16 and C17 discharge slowly, dangerous potentials exist within the power supply for several minutes after the POWER switch is turned OFF. The presence of voltage in the circuit is indicated by the relaxation oscillator R19, C19 and DS19. Neon bulb DS19 will blink until the potential across C16 and C17 drops to about 80 volts.

Spark gap electrodes E8 and E13 are surge-voltage protectors. When the LINE VOLTAGE SELECTOR switch is in the 115 volt position, only E8 is connected across the line input. If a peak voltage greater than 230 volts is present on the line, E8 will conduct and quickly open line fuse F10 to interrupt the input power before the instrument can be damaged. In the 230 volt position, E8 and E13 are connected in series across the line input to provide protection for peak voltages greater than 460 volts.

Transformer T8 provides a sample of the line voltage to the plug-in connectors for triggering at line frequencies. This line frequency signal is also connected to the Inverter Control stage to sense when line voltage is present.

INVERTER START

Components R10 and C42 provide a turn-on path between the input line and the negative side of line-input filter capacitor C17. Capacitor C42 charges on each cycle of the input line voltage. When the charge on C42 reaches about 33 volts, Zener diode VR38 turns on, which causes Q30, the programmable unijunction transistor, to fire. This provides base drive to turn on Q40 through C39. When Q40 turns on, it shock-excites series-resonant network L37 and C37 to generate a damped oscillation. This damped oscillation provides the drive necessary to start the Inverter switching action. After the Inverter is operating, the recurrent waveform at the collector of Q40 keeps C42 discharged through CR49, thus disabling the Inverter Start network while the instrument is on.

INVERTER

The Inverter stage converts the dc voltage across C16 and C17 to a sine-wave current to drive power transformer T110. Once the Inverter has been started by the Inverter Start network, transformer T30 provides feedback to the bases of Q34 and Q40 to sustain oscillation. These transistors operate at a forced beta of 4 due to the turns ratio of T30. Also, T30 provides a 60:1 turn ratio center-tapped winding for pre-regulation and

fault protection shut-down. The Inverter Control stage short circuits one-half of this winding to either delay the turn-on of Q34 and Q40 or to completely stop their switching action.

The switching action of Q34 and Q40 generates a square-wave voltage with an amplitude approximately equal to the dc voltage at the input to this stage. The square-wave voltage at the emitter of Q34 supplies the drive necessary to maintain a sine-wave current in the series-resonant network of L37 and C37. Diodes CR34 and CR41 provide paths for series-resonant current when Q34 and Q40 are held off for pre-regulation.

To aid in understanding circuit operation, Figure 3-24A shows a representation of the Inverter stage as a switch. The three possible states of the Inverter are depicted by the three possible switch positions: Q34 is on in position (a); Q40 is on in position (c); or both transistors are held off for pre-regulation in position (b). In the composite current waveform of Figure 3-24B, the relative phase and amplitude of each component of I_T is shown for periods T_a , T_b , and T_c corresponding to the three switch positions. Figure 3-24C and Figure 3-24D show the relationship of the Inverter voltage and primary winding voltages with respect to the current waveform.

The normal sequence of operation is as follows: assume that the voltage at point X is some voltage more positive than the negative supply voltage and that Q40 has just turned on. The current labeled I_1 in Figures 3-24A and 3-24B flows as the voltage at point W goes negative. Point X goes toward the negative supply voltage as C37 charges through L37. The voltage across the primaries of T110 and T35 at point Y produces a voltage at the secondary of T35 that is sensed by the Inverter Control IC, U75 (see Fig. 3-24D). When this voltage changes phase from negative to positive, Q40 is held off (turned off) by U75. Due to the inductive action of L37, current continues to flow through the Inverter circuit, pulling the voltage at point W below the negative supply voltage. This forward biases CR41, which now conducts I_1 (Figures 3-24A and 3-24B). After a predetermined time, the Inverter Control IC, U75, allows Q34 to turn on and conduct the current labeled I_2 in Figures 3-24A and 3-24B. Since Q34 is now conducting, the voltage at point X charges toward the positive supply voltage through L37. Once again, voltage phase change is sensed at the secondary of T35, by U75, as previously described. Transistor Q34 is held off at this time, and I_3 flows due to the inductive action of L37 pulling the anode of CR34 to a voltage greater than the positive supply voltage. After a time determined by the Inverter Control stage, Q40 conducts the current labeled I_4 , and the cycle repeats itself.

OVER-VOLTAGE STOP

Whenever the voltage across the primary of T110 exceeds a safe level, the Over-Voltage Stop stage shuts

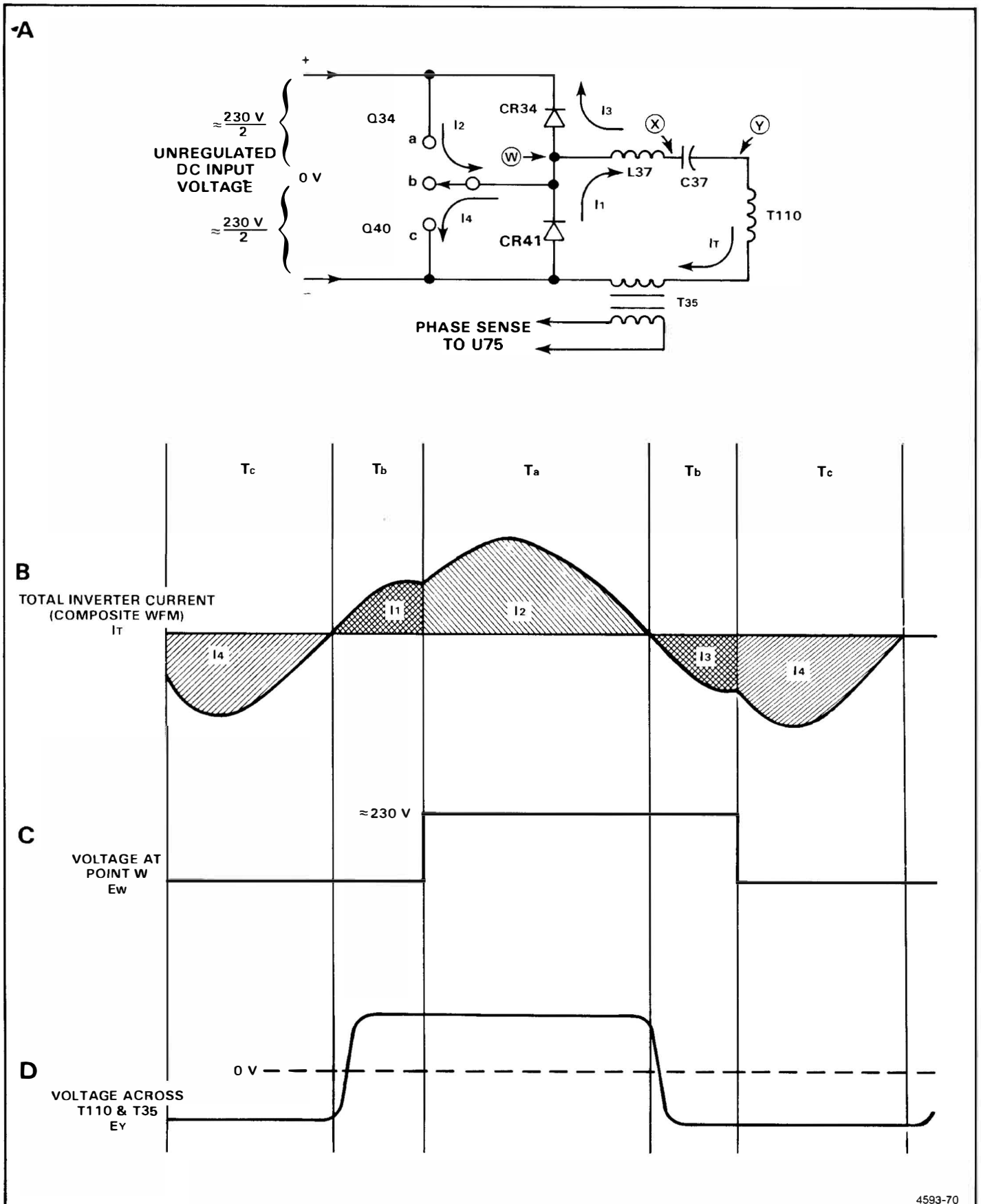

Figure 3-24. (A) Representation of Inverter stage. Idealized waveforms of (B) total inverter current, I_T , (C) Voltage across CR41 and (D) Voltage across primaries of T110 and T35.

Theory of Operation—7904A

down the Inverter to protect Inverter components from damage. For example, this stage activates whenever the normal voltage regulating path through Q52 and T30 is inoperative.

Capacitor C43 charges through R44 and CR38 to the peak voltage across the primary of T110. If this voltage exceeds a safe level, Q45 conducts to cause Q43 and Q46 to turn on. When Q46 turns on, the base-drive winding of T30 is short-circuited, which stops the Inverter switching action. Since Q43 is turned on, C42 (in the Inverter Start network) is prevented from charging and from firing Q30, thus preventing the Inverter from starting. Transistors Q45 and Q43 continue to conduct until C43 has discharged sufficiently, through R45, to turn Q45 off. At this point, Q43 and Q46 will turn off and the Inverter will start on the next positive half cycle of the line.

INVERTER CONTROL

The Inverter Control stage, made up of primarily of U75, provides pre-regulation and fault protection functions. For pre-regulation purposes, U75 varies the hold-off time (T_b , in Fig. 3-24B) of the Inverter switching transistors.

Under normal operating conditions, only the voltage sense (E Sense) input at pin 15 controls the hold-off time. However, various fault conditions can affect hold-off time or stop the Inverter operation altogether. The operation of individual functions of the Inverter Control stage is described in the following discussion.

Pre-Regulator

The pre-regulator operation of U75, maintains constant voltage at the outputs of the Low-Voltage Rectifiers stage. It also provides constant peak-to-peak voltage to the High-Voltage Power Supply and CRT circuit (diagram 13).

Transformer T35 provides Inverter phase information and power to U75. The phase information is connected to pins 10 and 11 through C77 and C78. Bridge rectifier CR73, CR74, CR76 and CR75, provides positive and negative operating voltages to U75. A shunt regulator in U75 maintains the +7.5 volts at pin 6. The -2 volt (nominal) supply connected to pin 7 is unregulated. Zener diode VR72 provides protection against open circuit conduction (U75 removed) and is normally not conducting.

Pin 15 is the voltage sensing (E Sense) point of the pre-regulator circuit. Zero volts at pin 15 indicates proper regulation. Zener diode VR88 provides a stable reference voltage for sensing-divider resistors R93, R95, R86 and R87. Variable resistor R93, in this divider, adjusts the ratio of the divider to adjust the output of the +108 volt supply. Outputs of the other supplies are then set by the turns ratio of T110.

Integrated circuit U75 regulates the Inverter by varying the hold-off time of the switching transistors, Q34 and Q40. A variable pulse-width monostable multivibrator in U75 is triggered at pins 10 and 11 whenever the Inverter current changes direction. The pulse width holds off the Inverter by turning on transistor Q52 through pin 9 of U75, thus shorting out the base drive to Q34 and Q40. The pulse width, and therefore holdoff, is controlled by a ramp at pin 12. If the voltage at the E Sense input, pin 15, is too low, the ramp is not allowed to rise very high and the pulse width and holdoff are short. As the E Sense voltage rises, the ramp is allowed to rise to a higher voltage level, increasing the holdoff time.

Fault Protection

The fault protection portions of U75 provide protection for the power supply components due to short circuits, turn-on surge currents, and other malfunctions. When a fault is detected at the Fault Sense input (pin 2) or I Sense input (pin 13), a current from the Fault Holdoff Time output (pin 1) charges C64. If the detected fault lasts longer than about 10 milliseconds, C64 will charge positive enough to initiate a positive output at pin 8. This output turns on Q54 and Q52 which turns off the Inverter. The Inverter will remain off while C54 discharges through R54, keeping Q54 and Q52 turned on. The Inverter restarts in roughly 500 milliseconds when the current through R54 is insufficient to keep Q54 and Q52 turned on. When the inverter restarts, C54 is recharged through CR59 and R59. This cycle repeats until the fault is corrected, with the Inverter on for about 10 milliseconds, and off for about 500 milliseconds.

Inverter Current Limiter

The inverter current limiter protects the Inverter components from damage due to excessive current turn-on or short circuits. Operation of this stage is similar to the pre-regulator (voltage regulation). The inverter current limiter takes control of the Inverter hold-off time whenever pin 13 starts to go negative. Transformer T35 provides a current step-down. The current is rectified and flows through R84, the current-sensing resistor. The voltage across R84 is negative and proportional to the Inverter current. The I Sense input at pin 13 U75 is normally held positive through divider R81, R82 and R83. The Inverter Current Limiter takes control of regulation when pin 13 reaches near zero volts. Peak Inverter current is limited to about 5 amperes. If the voltage at pin 13 remains near zero for more than about 10 milliseconds, pin 8 will go positive to turn off the Inverter.

Fault Sense

The fault sense portion of U75 provides overload protection for supplies on the Low Voltage Regulators and Fan Board schematic, (diagram 15) and other supplies generated throughout the instrument. Resistive networks from supplies are connected to the Fault Sense input at pin 2 of U75. During normal operation,

the voltage at the Fault Sense input remains near zero. If one of the inputs changes sufficiently to cause this voltage level to vary 200 millivolts (positive or negative) for more than 10 milliseconds, a positive output at pin 8 of U75 stops the Inverter.

Line Stop

The line stop portion of U75 stops the Inverter when the POWER switch, on the front panel, is turned OFF. The Line Stop stage will also stop the Inverter if the ac line voltage falls below a minimum value.

The line-frequency signal from transformer T8 is connected to pin 4, the Line Stop Sense input of U75. During normal operation, the line-frequency signal causes the Line Stop Timer terminal (pin 3) to periodically discharge to ground. When the line-frequency signal is interrupted or falls below a minimum value, C67 will charge to approximately +0.7 volts causing the Line Stop stage to produce a positive output at pin 8 of U75 which stops the Inverter.

LOW-VOLTAGE RECTIFIERS

The Low-Voltage Rectifiers stage rectifies the square-wave ac voltages at the output windings of T110 to the dc levels used for all regulated supplies in this instrument.



LOW-VOLTAGE REGULATORS AND FAN BOARD

A schematic diagram of the Low-Voltage Regulators and Fan Board circuit is given on diagram 15, in Section 8, Diagrams and Circuit Board Illustrations. The schematic is divided by gray shaded lines separating the circuitry into major stages. These aid in locating and identifying the components and portions of circuitry described here. Sub-headings in the following discussion use these stage names to further identify the components and portions of the circuitry shown on diagram 15.

The Low-Voltage Regulators convert semi-regulated voltages from the Converter/Rectifiers circuit (diagram 14) to stabilized low-ripple output voltages. The regulators are series type, using the +50 volt supply as a reference.

OPERATIONAL AMPLIFIER POWER SUPPLIES

The operational amplifiers used to regulate the +50, +15, +5, -50, and -15 volt supplies require that four special voltages be generated for their operation:

- (1) The +22 volt supply is generated from the semi-regulated +54 volt supply by reference zener diode VR32 and emitter follower Q34.
- (2) The -22 volt supply is generated from the semi-regulated -54 volt supply by reference zener diode VR36 and emitter follower Q38.

(3) The +5.6 volt supply is generated from the semi-regulated +17 volt supply by zener diode VR152.

(4) The -5.6 volt supply is generated from the semi-regulated -17 volt supply by zener diode VR156.

+50 V REGULATOR

Semi-regulated +54 volts from the Converter/Rectifiers circuit (diagram 14) provides the unregulated voltage source for this supply. Differential amplifier U15 compares the feedback voltage at pin 2 against the reference voltage at pin 3. The error output at pin 6 of U15 reflects a difference between these two inputs. Zener diode VR12 sets a reference level of about +9 volts at pin 3 of U15. A sample of the output voltage from the +50 volt supply is connected to pin 2 of U15 through divider network R16, R15 and R14. Variable resistor R15 in this divider sets the output level of this supply. Notice that the feedback voltage of this divider is obtained from a line labeled +50 VS (sense). If the feedback voltages were obtained at the supply, the voltage at the load would not stay constant, due to the inherent resistance of the interconnecting cable between the supply and its load. The sense configuration overcomes this problem by sensing the voltage at the load. Since the current in the sense line is small and constant, the load voltage is held constant regardless of the load current.

Regulation of voltage occurs as follows: If the output level of this supply decreases (becomes less positive) due to an increase in load or a decrease in input voltage (as a result of line-voltage change or ripple), the voltage across divider R16, R15 and R14 decreases also. This results in a less positive level, at pin 2 of U15, than that established by zener diode VR12 at pin 3 of U15. This decreases the current through CR15 and VR17 causing an increase in current through the base-emitter junction of Q28. This results in increased conduction of Q28, the +50 volt series regulator. The load current increases, therefore the voltage across the load also increases (becomes more positive) sufficiently to balance the input into differential amplifier U15. The +50 V ADJ, R15, sets the output level of this supply.

Current limiting is provided for the +50 volt supply if excessive current is demanded from the supply. Since the load is connected to this supply through R28, all current from the +50 volt supply must flow through this resistor. Under normal operation, there is insufficient voltage drop across R28 to turn Q22 off. However, when excessive current is demanded from the +50 volt series

regulator (Q28) due to a short circuit or similar malfunction at the output of this supply, the voltage drop across R28 increases and begins to turn off Q22. The reduced collector current of Q22 results in a reduction of current through Q28. This current-limiting protects Q28 from damage due to excessive power dissipation.

Theory of Operation—7904A

Several protection diodes are also included in this circuit. Diode CR28 prevents the output of this supply from going more negative than about -0.6 volt if it is shorted to a negative supply. Zener diode VR10 and diode CR10 supply a turn-on voltage for U15 to start the +50 volt supply when the instrument is first turned on. As soon as the +50 volt supply turns on, CR10 stops conducting.

-15 V REGULATOR

Basic operation of all stages in the -15 Regulator is the same as for the +50 Regulator. The reference level for this supply is established to ground through R82 at pin 5 of U84B. The divider ratio of R80 and R81 sets a level of zero volts at pin 6 of U84B. The level on the +50 VS (sense) line is held stable by the +50 volt supply. Any change at the output of the -15 volt supply appears at pin 6 of U84B as an error signal. The output voltage is regulated in the same manner as described for the +50 volt supply. Diode CR96 keeps the output of this supply from going more positive than about +0.6 volt if it is shorted to one of the more positive supplies. Operational amplifier U84A provides current limiting for Q94 by monitoring the voltage drop across R95. When too much current is demanded from the supply, the increased voltage drop across R95 allows U84A to turn Q88 off, reducing the current through Q94.

+5 V REGULATOR

The operation of the +5 V Regulator is basically the same as described for the previous supply regulators. Error voltage is provided through R131 to pin 2 of U114A, and pin 3 is referenced to the +50 VS (sense) line. The divider ratio of R113 and R114 is 10:1, so pin 3 of U114A is at +5 volts when the supply is operating normally. The level on the +50 V Sense line is held stable by the +50 volt supply. Therefore, any change at the output of the +5 volt supply appears at pin 2 of U114A as an error signal. The output voltage is regulated in the manner described previously for the +50 volt supply. Diode CR132 limits the output of this supply to about -0.6 volt, if it is shorted to one of the negative supplies.

The +5 volt current limiting, accomplished by U114B, protects this supply from excessive output current damage. With normal supply current through R133 and R134, the voltage drop across this parallel resistance biases Q118 on. If the current through R133 and R134 increases above a safe level, pin 7 of U114B reduces the forward bias current to Q118. Now, the base current of Q122 is reduced which decreases the voltage on the base of Q126. This limits the conduction of Q126 to a safe current level.

+15 V REGULATOR

The +15 V Regulator regulates in the same manner as the +50 volt supply; current limiting operates in the manner described for the +5 volt supply. Error feedback

voltage to pin 2 of U64A is provided through R69. Pin 3 of U64A is referenced to the +50 VS (sense) line. The divider ratio of R61 and R62 sets pin 3 of U64A at +15 volts. Any change in the output level of the +15 volt supply appears at pin 2 of U64A as an error signal. This results in an opposite change at the output, pin 1 of U64A, which is conveyed to the +15 volt series regulator transistor Q74, through CR64 and Q68, to correct the error in the output voltage of the supply. Diode CR76 limits the output of this supply to about -0.6 volt if it is shorted to one of the negative supplies.

-50 V REGULATOR

Operation of the -50 V Regulator is basically the same as described for the +50 volt supply; current limiting operates in a similar manner, as described for the +50 volt supply. Error voltage to pin 2 of U45 is provided by divider R45-R46 and is referenced to the -50 VS (sense) line. The divider ratio of R45 and R46 sets the level at pin 2 of U45 at zero volts when the output of this supply is correct. The protection diode CR58 limits the output voltage of this supply to +0.6 volt should the supply be shorted to a positive supply.

FAN CIRCUIT (SN B039999 & Below)

The fan motor used in this instrument is a brushless dc motor, using Hall Effect devices. The two Hall Effect devices sequentially drive the four transistors (Q20 A, B, C and D) which, in turn, control the current flow through the four field windings. The fan motor speed is regulated by limiting the current flow through Q10. Diodes CR21, CR22, CR23 and CR24 rectify the back voltage produced by the four field windings. This voltage is applied to the base of Q10 through resistive divider network R24, R25 and R11. The voltage developed by this circuit is proportional to the motor speed. If the motor speed starts to increase, the current drive to the base of Q10 will decrease, reducing the current to the motor, thus maintaining a constant motor speed.

FAN CIRCUIT (SN B040000 & Up)

Current for fan B20 is provided by the +15 V supply through P90 on Low Voltage Regulator board A22. The fan's 12 volt operating level is achieved by dropping approximately 3 volts across R20.

GRATICULE LIGHT SUPPLY

The Graticule Light Supply provides power to illuminate the graticule lights. The front-panel GRAT ILLUM potentiometer controls the output of this supply to set the brightness of the graticule lights. Transistors Q144, Q148 and diode CR148 form a voltage following current buffer. The output voltage at the collector of Q148 follows the voltage set at the base of Q144 by the divider made up of R142, R141, R143 and the front-panel GRAT ILLUM control on diagram 7. Resistor R148 limits the output current from this supply to protect Q148 from damage due to a short circuit.

MAINTENANCE

This section of the manual contains information for performing preventive maintenance, troubleshooting, and corrective maintenance for the 7904A Oscilloscope mainframe.

PREVENTIVE MAINTENANCE

Preventive maintenance, when performed on a regular basis, can prevent instrument breakdown and may improve the reliability of the instrument. The severity of the environment to which the instrument is subjected will determine the frequency of maintenance. A convenient time to perform preventive maintenance is before electrical adjustment of the instrument.

CABINET PANEL REMOVAL

WARNING

To avoid personal injury, do not touch sharp edges on instrument covers. Instruments equipped with Option 3 (meeting EMC specifications) have thin metal seals that could cause cuts and scratches.

Dangerous potentials exist at several points throughout this instrument. When the instrument is operated with the covers removed, do not touch exposed connections or components. Some transistors have voltages present on their cases. Disconnect power before cleaning the instrument or replacing parts.

The side, top, and bottom cabinet panels provide protection to personnel from operating potentials present within the instrument. In addition, they reduce radiation of electromagnetic interference from the instrument. The cabinet panels are held in place by slotted fasteners. To remove the panels, turn each fastener counterclockwise a quarter turn with a large screwdriver. Lift the panels away. Operate the instrument with the panels in place to protect the interior from dust.

CLEANING

The 7904A should be cleaned as often as operating conditions require. Accumulation of dirt in the instrument can cause overheating and component breakdown. Dirt on components acts as an insulating

blanket and prevents efficient heat dissipation. It also provides an electrical conduction path which may result in instrument failure. The side panels reduce the amount of dust reaching the interior of the instrument. Operation without the panels in place necessitates more frequent cleaning.

CAUTION

Avoid the use of chemical cleaning agents which might damage the plastics used in this instrument. Exercise care when cleaning Hypcon connectors; see cleaning instructions under Hypcon Connectors in this section. Use a nonresidue type of cleaner, preferably isopropyl alcohol, totally denatured ethyl alcohol, or a Freon TF cleaner such as Spray-On #2002. Before using any other type of cleaner, consult your Tektronix Service Center or representative.

EXTERIOR

Loose dust accumulated on the outside of the instrument can be removed with a soft cloth or small brush. The brush is particularly useful for dislodging dirt on and around the front-panel controls. Dirt which remains can be removed with a soft cloth dampened in a mild detergent and water solution. Abrasive cleaners should not be used.

CRT

Clean the plastic light filter, implosion shield, and the crt faceplate with a soft, lint-free cloth dampened with denatured alcohol.

The crt mesh filter (furnished with Option 3 only) can be cleaned as follows:

Maintenance—7904A

1. Hold the mesh filter in a vertical position and brush lightly with a soft, No. 7 water color brush to remove light coatings of dust or lint.
2. Greasy residues, or dried-on dirt, can be removed with a solution of warm water and a neutral-pH liquid detergent. Use the brush to lightly scrub the filter.
3. Rinse the filter thoroughly in clean water and allow to air dry.
4. If any lint or dirt remains, use clean low-pressure air to remove it. Do not use tweezers or other hard cleaning tools on the filter, as the special finish may be damaged.
5. When not in use, store the mesh filter in a lint-free dust-proof container, such as a plastic bag.

INTERIOR

Cleaning the interior of the instrument should only be occasionally necessary. The best way to clean the interior is to blow off the accumulated dust with dry, low-velocity air (approximately 5 lb/in²). Remove any dirt which remains with a soft brush or a cloth dampened with a mild detergent and water solution. A cotton-tipped applicator is useful for cleaning in narrow spaces, or for cleaning more delicate circuit components.



Circuit boards and components must be dry before applying power to prevent damage from electrical arcing.

The high-voltage circuits should receive special attention. Excessive dirt in this area may cause high-

voltage arcing and result in improper instrument operation.

VISUAL INSPECTION

The 7904A should be inspected occasionally for such defects as broken connections, improperly seated semiconductors, damaged or improperly installed circuit boards, and heat-damaged parts. The corrective procedure for most visible defects is obvious; however, particular care must be taken if heat-damaged parts are found. Overheating usually indicates other trouble in the instrument; therefore, correcting the cause of overheating is important to prevent recurrence of the damage.

SEMICONDUCTOR CHECKS

Periodic checks of semiconductors are not recommended. The best check of semiconductor performance is actual operation in the instrument. More details on semiconductors are given under Troubleshooting later in this section.

PERIODIC ELECTRICAL ADJUSTMENT

To ensure accurate measurements, check the electrical adjustment of this instrument after each 2000 hours of operation, or every 12 months if used infrequently. In addition, replacement of components may necessitate adjustment of the affected circuits. Complete adjustment instructions are given in Section 5, Checks and Adjustments. These procedures can be helpful in localizing certain troubles in the instrument and, in some cases, may correct them.

TROUBLESHOOTING

The following information is provided to facilitate troubleshooting of the 7904A Oscilloscope mainframe. Information contained in other sections of this manual should be used in conjunction with the following data to aid in locating a defective component. An understanding of the circuit operation is helpful in locating troubles. See Section 3, Theory of Operation, for this information.

TROUBLESHOOTING AIDS

DIAGRAMS

Complete schematic diagrams are given on the pullout pages in Section 8, Diagrams and Circuit Board Illustrations. The component number and electrical value of each component in this instrument are shown on these diagrams. (See the first page of the Diagrams and Circuit Board Illustrations section for definitions of the reference designators and symbols used to identify components in this instrument.) Important voltages and numbered waveform test points are also shown on the diagrams. The waveforms, and the numbered test points where they were obtained, are located adjacent to each diagram. The portions of circuits mounted on circuit boards are enclosed with heavy, solid-black lines.

CIRCUIT BOARD ILLUSTRATIONS

To aid in locating circuit boards, a circuit board location illustration appears on the back of the pullout page facing each schematic diagram. In addition, an illustration of the circuit board(s) is included here, with the physical location of the components and waveform test points that appear on the schematic diagram identified. Each circuit board illustration and schematic diagram is arranged in a grid locator with an index to facilitate rapid location of components contained on the circuit board and in the schematic diagrams.

ADJUSTMENT AND TEST POINT LOCATIONS

To aid in locating test points and adjustable components called out in the various sections of the Checks and Adjustments procedures, the Adjustment and Test Point Locations pullout pages are provided in the rear of Section 8, Diagrams and Circuit Board Illustrations.

COMPONENT COLOR CODING

The instrument contains carbon composition resistors, metal-film resistors, and wire-wound resistors. The resistance values of wire-wound resistors are usually printed on the component body. The resistance values of composition resistors and metal-film resistors are color coded on the components using the EIA color code (some metal-film resistors may have the value printed on the body). The color code is read starting with the stripe nearest the end of the resistor.

Composition resistors have four stripes, which consist of two significant figures, a multiplier, and a tolerance value (see Fig. 4-1). Metal-film resistors have five stripes consisting of three significant figures, a multiplier, and a tolerance value.

The values of common disc capacitors and small electrolytics are marked on the side of the component body. The white ceramic capacitors used in the instrument are color coded using a modified EIA code (see Fig. 4-1).

The cathode end of glass-encased diodes is indicated by a stripe, a series of stripes, or a dot (see Fig. 4-2). The cathode and anode ends of metal-encased diodes can be identified by the diode symbol marked on the body.

SEMICONDUCTOR LEAD CONFIGURATIONS

Lead configurations for semiconductor devices used in the 7904A Oscilloscope are shown in Figure 4-2.

STATIC-SENSITIVE DEVICES

CAUTION

Static discharge can damage any semiconductor component in this instrument.

This instrument contains electrical components that are susceptible to damage from static discharge. See Table 4-1 for relative susceptibility of various classes of semiconductors. Static voltages of 1 kV to 30 kV are common in unprotected environments.

Observe the following precautions to avoid damage:

1. Minimize handling of static-sensitive components.
2. Transport and store static-sensitive components or assemblies in their original containers, on a metal rail, or conductive foam. Label any package that contains static-sensitive assemblies or components.
3. Discharge the static voltage from your body by wearing a wrist strap while handling these

COLOR CODE

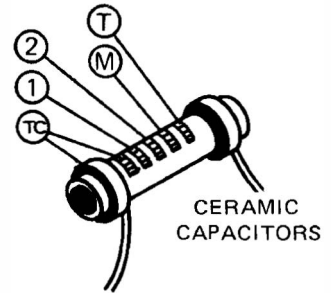
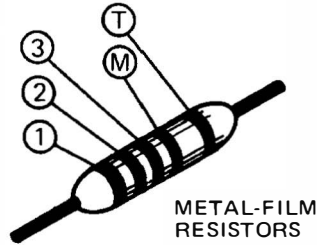
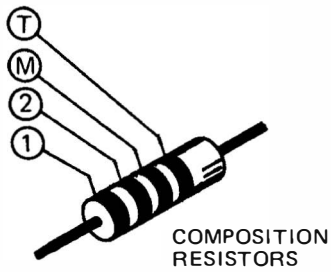

① ② and ③ - 1ST, 2ND, AND 3RD SIGNIFICANT FIGS. T AND/OR TC COLOR CODE MAY NOT BE PRESENT ON SOME CAPACITORS;
 M - MULTIPLIER T - TOLERANCE;
 TC - TEMPERATURE COEFFICIENT.

| COLOR | SIGNIFICANT FIGURES | RESISTORS | | CAPACITORS | | |
|--------|---------------------|--------------------------|-----------|-------------------------------|--------------|------------|
| | | MULTIPLIER (OHMS) | TOLERANCE | MULTIPLIER (pF) | TOLERANCE | |
| | | | | | OVER 10pF | UNDER 10pF |
| BLACK | 0 | 1 | ---- | 1 | ±20% | ± 2pF |
| BROWN | 1 | 10 | ±1% | 10 | ±1% | ±0.1pF |
| RED | 2 | 10 ² or 100 | ±2% | 10 ² or 100 | ±2% | ---- |
| ORANGE | 3 | 10 ³ or 1 K | ±3% | 10 ³ or 1000 | ±3% | ---- |
| YELLOW | 4 | 10 ⁴ or 10K | ±4% | 10 ⁴ or 10,000 | +100% -0% | ---- |
| GREEN | 5 | 10 ⁵ or 100 K | ±1/2% | 10 ⁵ or 100,000 | ±5% | ±0.5pF |
| BLUE | 6 | 10 ⁶ or 1 M | ±1/4% | 10 ⁶ or 1,000,000 | ---- | ---- |
| VIOLET | 7 | ---- | ±1/10% | 10 ⁷ or 10,000,000 | ---- | ---- |
| GRAY | 8 | ---- | ---- | 10 ⁻² or 0.01 | +80% -20% | ±0.25pF |
| WHITE | 9 | ---- | ---- | 10 ⁻¹ or 0.1 | ±10% | ±1pF |
| GOLD | ---- | 10 ⁻¹ or 0.1 | ±5% | ---- | ---- | ---- |
| SILVER | ---- | 10 ⁻² or 0.01 | ±10% | ---- | ---- | ---- |
| NONE | ---- | ---- | ±20% | ---- | ±10% | ±1pF |

Figure 4-1. Color code for resistors and capacitors.

NOTE
LEAD CONFIGURATIONS AND CASE STYLES ARE TYPICAL, BUT MAY VARY DUE TO VENDOR CHANGES OR INSTRUMENT MODIFICATIONS.

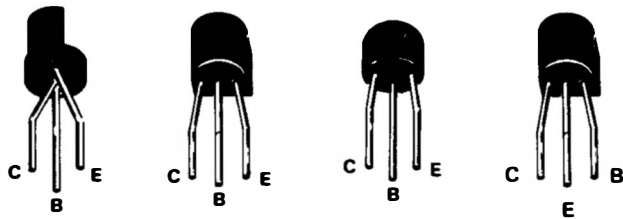

PLASTIC-CASED TRANSISTORS

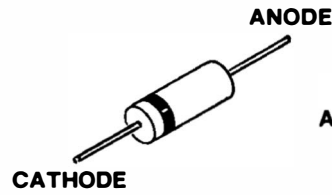

SIGNAL DIODE



LIGHT EMITTING DIODE (L.E.D.)

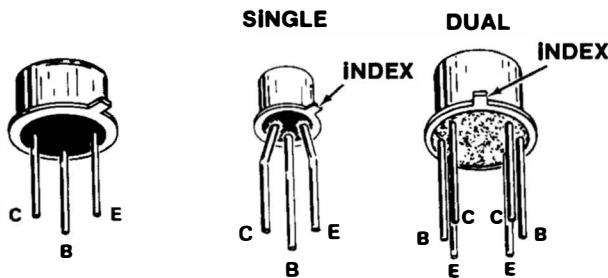

METAL-CASED TRANSISTORS



PLASTIC-POWER TRANSISTOR

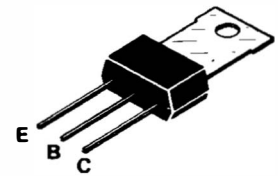

DARLINGTON TRANSISTOR

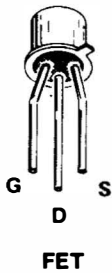

FET

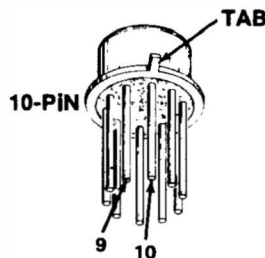

10-PIN

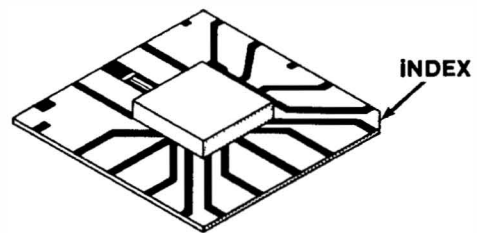

INDEX

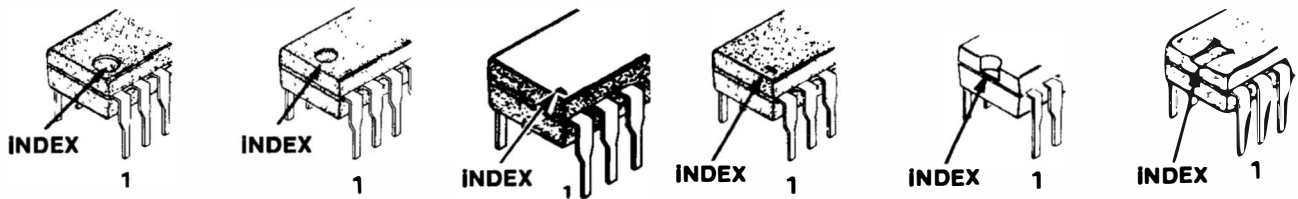

IC PINS ARE NUMBERED COUNTERCLOCKWISE FROM THE INDEX (VIEWED FROM THE TOP).

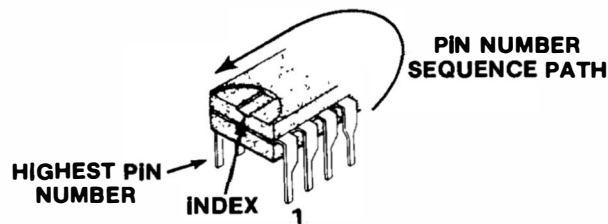

INTEGRATED CIRCUITS

4593-401A

Figure 4-2. Semiconductor lead configurations.

TABLE 4-1
Relative Susceptibility To
Static Discharge Damage

| Semiconductor Classes | Relative Susceptibility Levels ¹ |
|---|---|
| MOS or CMOS microcircuits or discretes, or linear microcircuits with MOS inputs. (Most Sensitive) | 1 |
| ECL | 2 |
| Schottky signal diodes | 3 |
| Schottky TTL | 4 |
| High-frequency bipolar transistors | 5 |
| JFETs | 6 |
| Linear Microcircuits | 7 |
| Low-power Schottky TTL | 8 |
| TTL (Least Sensitive) | 9 |

¹Voltage equivalent for levels:

- | | |
|------------------|--------------------------|
| 1 = 100 to 500 V | 6 = 600 to 800 V |
| 2 = 200 to 500 V | 7 = 400 to 1000 V (est.) |
| 3 = 250 V | 8 = 900 V |
| 4 = 500 V | 9 = 1200 V |
| 5 = 400 to 600 V | |

(Voltage discharged from a 100 pF capacitor through a resistance of 100 ohms.)

components. Servicing static-sensitive assemblies or components should be performed only at a static-free work station by qualified service personnel.

- Nothing capable of generating or holding a static charge should be allowed on the work station surface.
- Keep the component leads shorted together whenever possible.
- Pick up components by the body, never by the leads.
- Do not slide the components over any surface.
- Avoid handling components in areas that have a floor or work-surface covering capable of generating a static charge.
- Use a soldering iron that is connected to earth ground.
- Use only special antistatic vacuum type desoldering tools such as the Pace model PC10.

MULTI-PIN CONNECTORS

Pin 1 on multi-pin connectors is designated with a triangle. A triangle, dot or square printed on circuit

boards denotes pin 1. When a connection is made to a circuit board, the orientation of the triangle on the multi-pin holder is determined by the index (triangle, dot or square) printed on the circuit board (see Fig. 4-3). Some multi-pin connectors are keyed with a plastic pin that protrudes through a hole on the circuit board. Proper mating with the multi-pin connector and the pin(s) on the circuit board cannot be accomplished unless this pin is aligned with the hole on the circuit board.

Some multi-pin connectors are equipped with a locking mechanism to more readily secure the connector to the circuit board. To remove these connectors, grasp the connector body and pull perpendicular to the circuit board. They should not be removed by pulling on the wire leads; this causes the locking mechanism to clamp onto the circuit board pins.

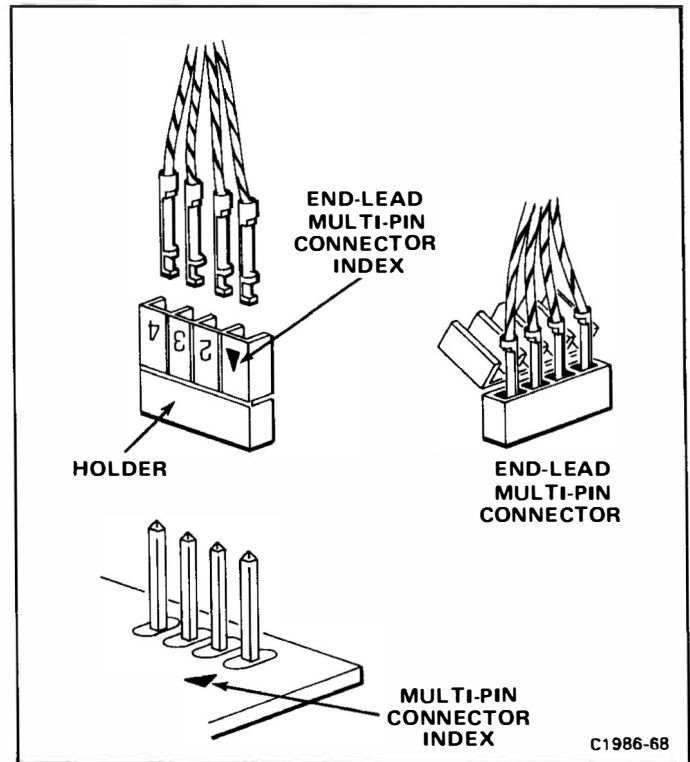

Figure 4-3. Orientation of multi-pin connectors.

TROUBLESHOOTING EQUIPMENT

The following equipment is useful for troubleshooting the 7904A Oscilloscope mainframe:

- Transistor Tester

Description: Dynamic-type tester.

Purpose: Test semiconductors.

Recommended type: TEKTRONIX 577/177 Curve Tracer, TEKTRONIX 576 Curve Tracer, 7CT1N Curve Tracer plug-in unit and a 7000-series oscilloscope system, or a 5CT1N Curve Tracer plug-in unit and a 5000-series oscilloscope system.

2. Digital Multimeter

Description: 10 megohm input impedance and 0 to 1 kilovolt range, ac and dc; ohmmeter accuracy, within 0.1%. Test probes must be insulated to prevent accidental shorting.

Purpose: Check voltages and resistances.

Recommended type: TEKTRONIX DM 501A Digital Multimeter (requires TM 500 power module).

3. Test Oscilloscope

Description: Frequency response, dc to 100 megahertz minimum; deflection factor, 5 millivolts to 5 volts/division and 1 milliampere to 1 ampere/division. A 10X, 10-megohm voltage probe should be used to reduce circuit loading for voltage measurements. For current waveforms, use a Tektronix P6021 Current Probe with passive termination, or the equivalent.

Purpose: Check operating waveforms.

Recommended type: Refer to the Tektronix Products catalog for applicable oscilloscope system.

4. Variable Autotransformer

Description: Output variable from 0 to 140 volts, 10 amperes minimum rating. Must have three-wire power cord, plug, and receptacle.

Purpose: Vary input line voltage when troubleshooting in the power-supply unit.

Recommended type: General Radio W10MT3W Variac Autotransformer.

5. Isolation Transformer

Description: 1:1 turns ratio, 500 volt-amperes minimum rating, 50-60 cycle. Must have three-wire power cord, plug, and receptacle with ground connection carried through from input to output.

Purpose: To isolate 7904A from line potential when troubleshooting power supply.

Recommended type: Stancor #P6298 (for 115-volt line only) modified to include three-wire power cord, plug, and receptacle.

TROUBLESHOOTING TECHNIQUES

This troubleshooting procedure is arranged to check the simple trouble possibilities before proceeding with extensive troubleshooting. The first few checks ensure proper connection, operation, and adjustment. If the trouble is not located by these checks, the remaining steps aid in locating the defective component. When the defective component is located, replace it following the replacement procedures given under Corrective Maintenance.

1. CHECK CONTROL SETTINGS

Incorrect control settings can indicate a trouble that does not exist. If there is any question about the correct function or operation of any control on the 7904A, refer to Section 2, Operating Instructions.

2. CHECK ASSOCIATED EQUIPMENT

Before proceeding with troubleshooting, check that the equipment used with this instrument is operating correctly. Also, check that the input signals are properly connected and that the interconnecting cables are not defective. Check the line-voltage source.

3. VISUAL CHECK

Visually check that portion of the instrument in which the trouble is located. Many troubles can be found by visible indications, such as unsoldered connections, loose cable connections, broken wires, damaged circuit boards, and damaged components.

4. CHECK INSTRUMENT ADJUSTMENT

Check the electrical adjustment of this instrument, or of the affected circuit if the trouble appears in one circuit. The apparent trouble may only be a result of maladjustment. Complete adjustment instructions are given in Section 5, Checks and Adjustments.

5. ISOLATE TROUBLE TO A CIRCUIT

To isolate trouble to a particular circuit, note the trouble symptom. The symptom often identifies the circuit in which the trouble is located. When trouble symptoms appear in more than one circuit, check the affected circuits by taking voltage and waveform measurements. Also check for the correct output signals at the front- and rear-panel output connectors with a test oscilloscope. If the signal is correct, the circuit is working correctly up to that point. For example, correct sawtooth output indicates that the time-base unit and sawtooth output portion of the Output Signals circuit is operating correctly. If a malfunction in the Readout System is suspected of causing trouble to appear in the Z-Axis Amplifier, Vertical Amplifier, or Horizontal Amplifier circuits, the trouble can be localized by removing the Readout System circuit board. This board can be removed without significantly affecting the operation of other circuits in the instrument.

Maintenance—7904A

Incorrect operation of all circuits often indicates trouble in the power supply. Check first for correct voltage of the individual supplies. However, a defective component elsewhere in the instrument can appear as a power-supply trouble and may also affect the operation of other circuits. If incorrect operation of the power supplies is suspected, refer to Troubleshooting the High-Efficiency Power-Supply Unit given later in this section.

6. CHECK VOLTAGES AND WAVEFORMS

Often the defective component can be located by checking for the correct voltages or waveforms in the circuit. Typical voltages and waveforms are given in Section 8, Diagrams and Circuit Board Illustrations.

NOTE

Voltages and waveforms given in Section 8, Diagrams and Circuit Board Illustrations, are not absolute and may vary slightly between 7904A Oscilloscope mainframes. To obtain operating conditions similar to those used to take these readings, see the appropriate schematic.

7. CHECK INDIVIDUAL COMPONENTS

The following procedures describe methods of checking individual components in the 7904A. Components which are soldered in place are best checked by first disconnecting one end. This isolates the measurement from the effects of surrounding circuitry.

WARNING

To avoid electric-shock hazard, always disconnect the 7904A from the power source before removing or replacing components.

Fuses

Access to the 7904A line fuse is through the instrument rear panel. To check for an open fuse, measure continuity with an ohmmeter.

Transistors

A good check of transistor operation is actual performance under operating conditions. A transistor can most effectively be checked by substituting a new component for it (or one which has been previously checked). However, be sure that circuit conditions are not such that a replacement transistor might also be damaged. If substitute transistors are not available, use a dynamic tester. Static-type testers are not recommended, since they do not check operation under simulated operating conditions.

Integrated Circuits

Integrated circuits can be checked with a voltmeter, test oscilloscope, or by direct substitution. A good understanding of the circuit operation is essential to troubleshooting circuits using integrated circuits. In addition, operating waveforms, logic levels, and other operating information for the integrated circuits are given in Section 3, Theory of Operation and Section 8, Diagrams and Circuit Board Illustrations. Use care when checking voltages and waveforms around the integrated circuits so that adjacent leads are not shorted together. A convenient means of clipping a test probe to the in-line, multi-pin integrated circuits is with an integrated-circuit test clip. This device also doubles as an integrated-circuit extraction tool.

Diodes

A diode can be checked for an open or shorted condition by measuring the resistance between terminals with an ohmmeter on a scale having a low internal source current, such as the $R \times 1k$ scale. The resistance should be very high in one direction and very low when the meter leads are reversed.

CAUTION

When checking diodes, do not use an ohmmeter scale that has a high internal current, since high currents may damage the diodes under test.

Resistors

Check the resistors with an ohmmeter. Resistor tolerances are given in Section 7, Replaceable Electrical Parts. Normally, resistors do not need to be replaced unless the measured value varies widely from the specified value.

Capacitors

A leaky or shorted capacitor can best be detected by checking resistance with an ohmmeter on the highest scale. Do not exceed the voltage rating of the capacitor. The resistance reading should be high after initial charge of the capacitor. An open capacitor can best be detected with a capacitance meter or by checking whether the capacitor passes ac signals.

8. REPAIR AND ADJUST THE CIRCUIT

If any defective parts are located, follow the replacement procedures given under Component Replacement in this section. Check the performance of any circuit that has been repaired or that has had any electrical components replaced. Adjustment of the circuit may be necessary.

TROUBLESHOOTING THE HIGH-EFFICIENCY POWER-SUPPLY UNIT

GENERAL

The following information is provided to facilitate troubleshooting the high-efficiency power-supply unit. Information contained in other sections of this manual should be used in conjunction with this procedure to aid in locating a defective component. An understanding of the circuit operation is valuable in locating troubles. See Section 3, Theory of Operation, for this information. Specifications for the troubleshooting equipment referred to in this procedure are given earlier in this section under Troubleshooting Equipment.

WARNING

Extreme caution must be used when troubleshooting in the power-supply unit due to the line voltage and the high-voltage/high-current potentials present in the unit.

When a fault condition occurs, which is not of sufficient magnitude to open the line fuse, power-supply protection circuitry will cause the inverter to operate in a pulse mode. In this mode the inverter will turn on for a short period of time, and then turn off for a longer period of time. This cycle repeats until the malfunction is corrected. This pulse mode causes either a “ticking” or a “chirping” sound. Whenever either of these sounds is heard, turn off the 7904A and proceed with the Preliminary Procedure given below.

PRELIMINARY PROCEDURE

WARNING

To avoid electric shock, always disconnect the instrument from the power source before removing or replacing components or plug-in units.

1. Remove all plug-in units from the mainframe.
2. Set the CONTROL ILLUMINATION switch on the rear panel to the OFF position, and the GRAT ILLUM switch on the front panel to the fully-counterclockwise position.
3. Remove the power-supply unit from the mainframe following the procedure given later in this section under Component Removal and Replacement.
4. Connect the power-cord plug of the 7904A to the output of a variable autotransformer which is set for 115 volts. Connect the autotransformer to an isolation transformer and plug the isolation transformer into a 115-volt power source.

TABLE 4-2
Recommended Power Supply
Troubleshooting Sequence

| Trouble Symptom | Procedure | Proceed To Troubleshooting Step: |
|---|--|----------------------------------|
| 7904A inoperative; no pulse mode. | 1. Check line fuse. | A |
| 7904A inoperative; no pulse mode; line fuse open. | 1. Check line input circuit. | D |
| | 2. Check LV rectifier circuit. | H |
| | 3. Check inverter circuit. | G |
| 7904A inoperative; no pulse mode; line fuse normal. | 1. Check inverter circuit. | G |
| 7904A operating in the pulse mode. | 1. Isolate Power supply malfunction from the main-frame circuitry. | B |
| | 2. Check pre-regulated power supplies. | C |
| | 3. Check crt and high-voltage circuits. | E |
| | 4. Check inverter control circuit. | F |
| | 5. Check inverter circuit. | G |

5. Push the 7904A POWER button in (to turn the instrument on) and note the trouble symptoms.
6. Turn the 7904A off and proceed to the appropriate step in the Troubleshooting Procedure as indicated by the Trouble Symptom column in Table 4-2.

TROUBLESHOOTING PROCEDURE

Step A: Check Line Fuse

To check the line fuse, perform the following procedure:

1. Check the line fuse (F10), located on the rear panel of the power-supply unit for continuity and proper rating as given in Section 7, Replaceable Electrical Parts.
2. If the line fuse is open, replace with a new one of proper rating.

Step B: Isolate Power Supply Malfunction from the Mainframe Circuitry

To isolate the malfunction perform the following procedure:

WARNING

Use extreme caution when troubleshooting in the power-supply unit, to avoid electric shock. Stored dc potentials on the A23-Power Supply Inverter circuit board remain long after the instrument is disconnected from the power source. Verify that the power-cord plug is disconnected and that the line storage capacitors (A23C16 and A23C17) are completely discharged before attempting any repairs or resistance measurements. (A warning-indicator neon bulb, located on the A23-Inverter board, flashes when this stored voltage exceeds about 80 volts. However, simply because the neon bulb is not flashing does not mean that the capacitors are fully discharged.)

1. Remove the 7904A power-cord plug from the power source.
2. Remove the protective cover from the power-supply unit following the procedure under Access to Components in the Power-Supply Unit.
3. Manually discharge the line storage capacitors using the procedure given later in this section, under Access to Components in the Power-Supply Unit.
4. Check the resistance of the power supplies at the test points given in Table 4-3. (The Power Supply Test points are located on the A28-Horizontal Amplifier circuit board; see Figure 8-1.)

NOTE

Place the Common lead of the ohmmeter to ground when measuring power-supply resistance.

5. If any of the resistance readings are significantly lower than that listed, remove the electrical connections between the mainframe and the power-supply unit. Disconnect P17, P82, P83 on the A22-Low-Voltage Regulator board. This isolates the circuitry in the mainframe from the power-supply unit. Recheck the resistance. If the readings remain low, the malfunction is located within the mainframe circuits. If the readings increase to normal or above, the malfunction is in the power supplies.
6. Replace all electrical connections that were disconnected in part 5.

**TABLE 4-3
Typical Power-Supply Resistance**

| Power Supply Test Point | Ohmmeter Scale | Typical Resistance Reading |
|-------------------------|----------------|----------------------------|
| +130 V | 20 K | 7.12 K |
| +50 V | 20 K | 2.65 K |
| +15 V | 20 K | 0.04 K |
| +5 V | 2 K | 0.004 K |
| -5 V | 2 K | 0.068 K |
| -15 V | 2 K | 0.05 K |
| -50 V | 2 K | 0.57 K |

Step C: Check the Pre-Regulated Power Supplies

To check the pre-regulated power supplies, perform the following procedure:

1. Connect a 10X voltage probe from the test oscilloscope to resistor R84 on the A12-Control Rectifier board. (Refer to "Access to Components in the Power Supply" for access to A12 Control Rectifier circuit board. Refer to the component locator, opposite diagram 14 in Section 8—Diagrams and Circuit Board Illustrations, for the location of A12R84.) Set the test oscilloscope vertical deflection factor as necessary for an on-screen display; set the horizontal sweep rate for 2 milliseconds/division.
2. Set the variable autotransformer for 115 volts. Connect the 7904A power-cord plug to the variable autotransformer; turn on the 7904A.
3. Compare the waveform on the test oscilloscope to those shown in Figure 4-4. If the waveform resembles that of Figure 4-4A, proceed to Step E of this procedure. If it resembles that of Figure 4-4B, proceed with part 4 of this step.
4. Remove the 10X voltage probe from R84. Set the test oscilloscope vertical coupling to dc and the horizontal sweep rate to 10 milliseconds/division.
5. Connect the 10X probe to each power supply at the Burst Voltage Test Points given in Table 4-4. For location of the Burst Voltage Test Points refer to the component locator for the A12 Control Rectifier Circuit Board (located opposite Converter/Rectifier schematic diagram number 14 in Section 8—Diagrams and Circuit Board Illustrations). Note the polarity, amplitude, and shape of the waveform present at each test point. (Adjust the vertical deflection factor of the test oscilloscope as necessary to maintain an on-screen display.)

NOTE

Look for a power supply where the burst voltage is very low in relation to the specified supply voltage.

- When a low supply voltage is found, disconnect the 7904A from the power source and discharge the line storage capacitors (Fig. 4-5) following the procedure given under Access to Components in the Power-Supply Unit. Check for shorted components in the suspected power supply; also check the filter capacitors for leakage.

TABLE 4-4
Burst Voltage Test Points

| Pre-Regulated Power Supply | Test Point Located On A12-Control Rectifier Board |
|----------------------------|---|
| +108 V | TP126 |
| +54 V | Pin 4 of P52 |
| +17 V | Pin 6 of P52 |
| -17 V | Pin 2 of P52 |
| +8 V | Pin 7 of P50 |
| -54 V | Pin 3 of P52 |
| +5 V Lights | Pin 10 of P82 |

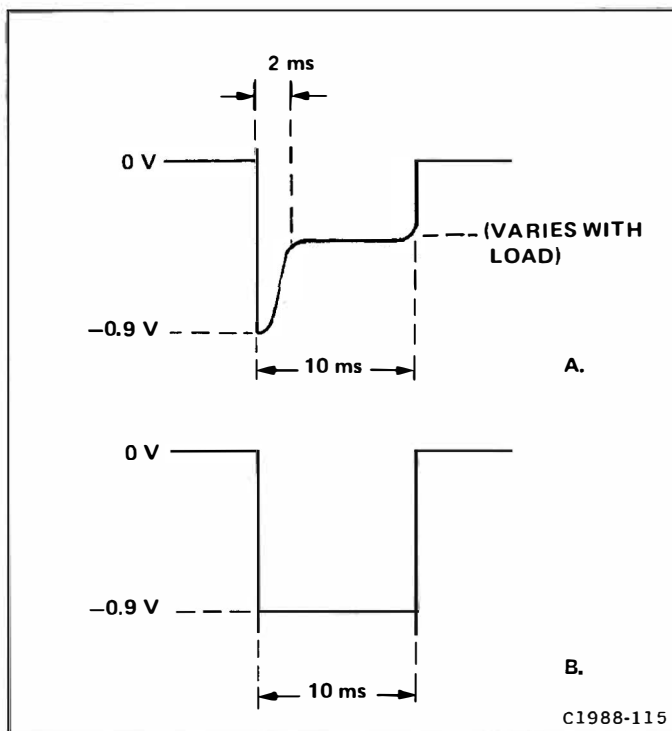

Figure 4-4. Current sensing waveform at A12R84.

Step D: Check Line Input Circuit

To check the input circuit, perform the following procedure:

- Disconnect the 7904A from the variable autotransformer and discharge the line storage capacitors (Fig. 4-5) following the procedure given under Access to Components in the Power-Supply Unit.
- Replace the line fuse.
- Check diode bridge CR15 on the A23-Power Supply Inverter board and the associated line input circuit for a shorted components. If the circuit appears normal, connect the power-cord to the variable autotransformer.
- Attach the test probe from the digital multimeter to one of the screws used to discharge C16 and C17 (see Fig. 4-5). Connect the other test lead to ground. Set the variable autotransformer for 20 volts and turn the 7904A on.

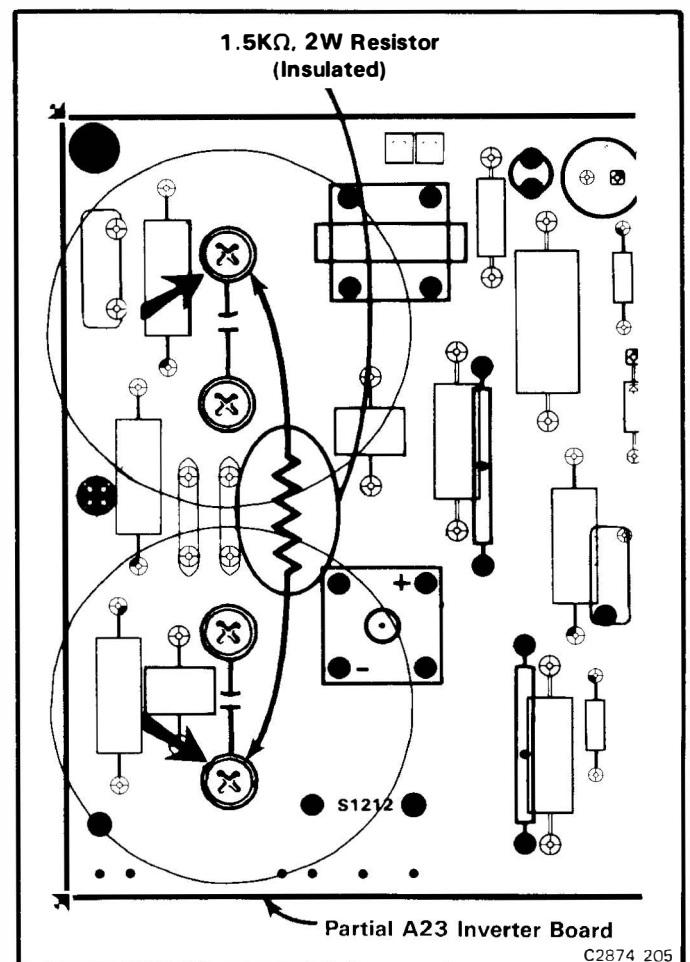

Figure 4-5. Location of screws for discharging line storage capacitors.

Maintenance—7904A

5. Check for a dc voltage on the digital multimeter of approximately 27 volts. Move the test probe to the other capacitor screw. Check for a dc voltage which is both equal and opposite in polarity from the previous voltage. (This checks the condition of the line storage capacitors.)

Step E: Check CRT and High-Voltage Circuit

To check the crt circuitry, perform the following procedure:

1. Disconnect the 7904A from the power source and discharge the line storage capacitors following the procedure given under Access to Components in the Power-Supply Unit.
2. Remove multi-lead cable P40 from the A12-Control Rectifier board.
3. Set the variable autotransformer for 115 volts. Connect the 7904A power-cord plug to the variable autotransformer; turn the 7904A power on.
4. Check for stable operation (no pulse mode) of the power supplies. If the power supplies operate properly, a crt failure or malfunction in the high-voltage circuitry is indicated.

Step F: Check the Inverter Control Circuit

To check the inverter control circuit, perform the following procedure:

1. Disconnect the 7904A from the power source and discharge the line storage capacitors following the procedure given under Access to Components in the Power-Supply Unit (see Fig. 4-5).
2. Remove Q54 from the A12-Control Rectifier board.
3. Connect the 7904A power-cord plug to the variable autotransformer. Turn the 7904A on and apply 115 volts from the variable autotransformer. If the power supplies stabilize, check the inverter control circuit for a malfunction. If the 7904A continues in pulse mode, proceed to part 4 of this step.
4. Repeat part 1 of this step. Then remove Q52 from the A12-Control Rectifier board.
5. Set the variable autotransformer to 0 volts. Connect the 7904A power-cord plug to the variable autotransformer. Turn the 7904A power on. While monitoring the +108 V test point on the A12-Control Rectifier circuit board with a voltmeter, slowly increase the output of the variable autotransformer until the voltmeter just reads +108 volts. (The 108-volt test point is accessible through the A12R93 Pre Reg Adj hole, marked R1293 on the panel, in the bottom of the Power Supply Unit.)

NOTE

If the variable transformer's output is increased past the point where the voltmeter just reaches a reading of +108 volts, the 7904A will switch to pulse mode.

6. If the power supplies stabilize, check A12U75 and the inverter control circuit for a malfunction. If the 7904A continues in the pulse mode, proceed to Step G of this procedure.

Step G: Check Inverter Circuit

To check the inverter circuit, perform the following procedure:

1. Disconnect the 7904A power-cord plug from the power source and discharge the line storage capacitors following the procedure given under Access to Components in the Power-Supply Unit.
2. Remove Q34, Q40, CR34, and CR41 on the A23-Power Supply Inverter circuit board and check the characteristics of each with a curve tracer. Install the checked or replaced components in the A23-Inverter board. Replace the line fuse, if it is open.
3. If the faulty component was not found, check Q43, Q45 and VR45 on the A23-Power Supply Inverter circuit board with a curve tracer.

NOTE

A shift in the zener voltage of VR45 can cause erratic operation of the inverter circuit.

4. If the 7904A continues in the pulse mode or continues to blow line fuses, check the current waveform through T30 on the A23-Power Supply Inverter circuit board. To do this, first repeat part 1 of this step. Then connect a current probe from the test oscilloscope to the gray lead that passes through toroid transformer T30. Set the test oscilloscope for a vertical deflection factor of about 1 volt/division and a horizontal sweep rate of 2 milliseconds/division. Connect the 7904A power-cord plug to the variable transformer which is set for 0 volt. Turn the 7904A on and slowly increase the variable autotransformer output to about 60 volts. Check for a burst waveform on the test oscilloscope (similar to that shown in Fig. 4-6).

NOTE

The burst waveform indicates that the inverter circuit is attempting to start. If no burst waveform occurs, proceed to part 6; if a burst waveform is obtained, proceed to part 5.

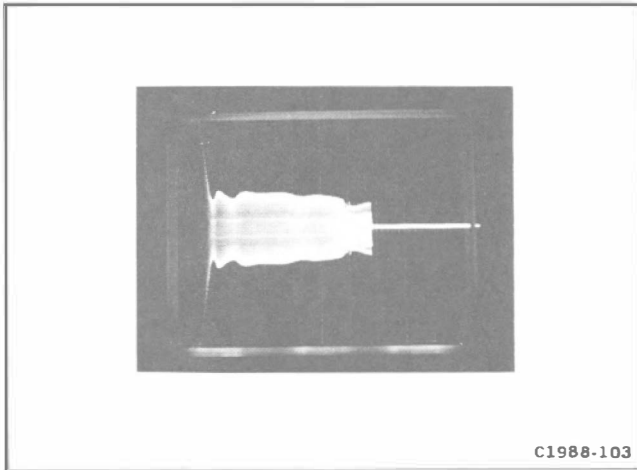

Figure 4-6. Current waveform of A23T30 showing burst operation at line voltage of about 60 volts.

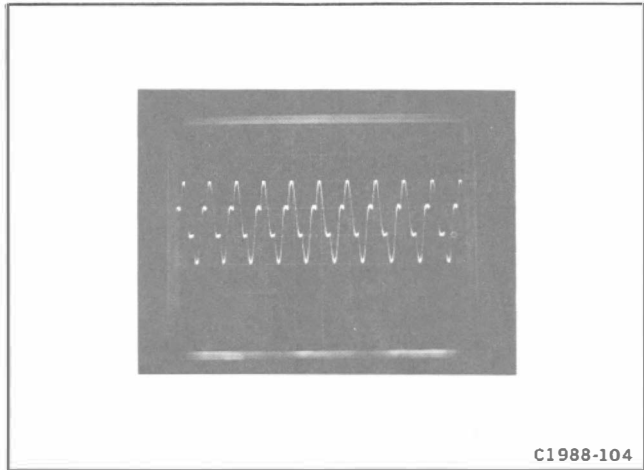

Figure 4-7. Current waveform at A23T30 for normal Inverter operation at line voltage of 115 volts.

5. If a burst waveform was obtained in part 4 above, check for stable inverter operation when the line input voltage is increased to about 85 volts. Figure 4-7 shows the current waveform at A23T30 for normal inverter operation at a line source of 115 volts. (NOTE: The test oscilloscope horizontal sweep rate has been changed to about 50 microseconds/division for Fig. 4-7).
6. If no burst waveform occurred in part 4, repeat part 1 of this step. Then remove the current probe from the 7904A and the test oscilloscope. Connect a 10X voltage probe from the test oscilloscope to TP34 on the A23-Power Supply Inverter board. (Assuming that access to the A23 Power Supply Inverter circuit board has previously been gained, remove the line inverter shield from the circuit board. TP34 is labeled "TANK" on the A23 Power Supply Inverter circuit board.) Set the variable autotransformer for 20 volts and check for a filtered line waveform which is centered at 0 volt (see Fig. 4-8). If the waveform is not centered check Q46, CR32, CR40, CR49, and CR45 for shorts or leakage.

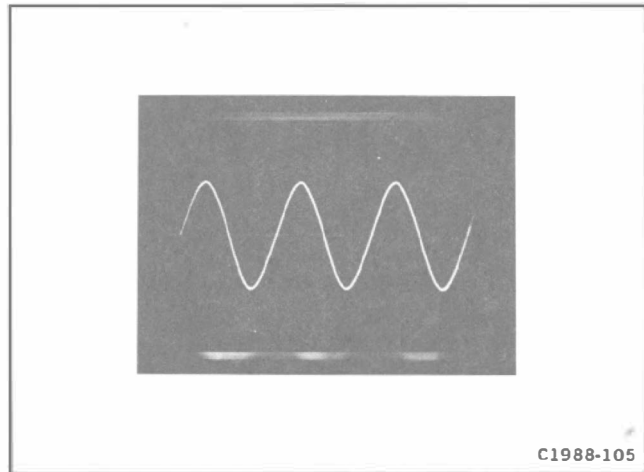

Figure 4-8. Waveform at IP34 on the A23 Power Supply Inverter circuit board with the line-voltage at about 20 volts.

Step H: Check LV Rectifier Circuit

1. Disconnect the 7904A power-cord plug from the power source and discharge the line storage capacitors in the power-supply unit, following the procedure given under Access to Components in the Power-Supply Unit. Inspect the A12-Control Rectifier circuit board and connecting cables for shorts and damaged components.
2. Remove dual diode CR151 from the A12-Control Rectifier board and check with a curve tracer. Reinstall tested or replaced parts, making certain that the case is not shorted to the heat sink.
3. Lift one leg each of CR140, CR141, CR142, and CR143 on the A12-Control Rectifier board and check with a curve tracer. Reconnect tested or replaced parts.
4. Lift one leg each of CR130, CR131, CR132, CR133, CR150, and CR153 on the A12-Control Rectifier board and check with a curve tracer. Reconnect tested or replaced parts.
5. Check the electrolytic capacitors which filter the supplies, including C154 (under the board) for shorts.

CORRECTIVE MAINTENANCE

Corrective maintenance consists of component replacement and instrument repair. Special techniques required to replace components in the 7904A Oscilloscope mainframe are given here.

OBTAINING REPLACEMENT PARTS

Most electrical and mechanical part replacements for the 7904A can be obtained through your Tektronix Field Office or representative. However, many of the standard electronic components can be obtained locally in less time than is required to order them from Tektronix, Inc. Before purchasing or ordering replacement parts, check the parts list for value, tolerance, rating, and description.

NOTE

When selecting replacement parts, remember that the physical size and shape of a component may affect its performance in the instrument. All replacement parts should be direct replacements unless you know that a different component will not adversely affect instrument performance.

SPECIAL PARTS

Some parts are manufactured or selected by Tektronix, Inc. to satisfy particular requirements, or are manufactured for Tektronix, Inc. to our specifications. Most of the mechanical parts used in this instrument have been manufactured by Tektronix, Inc. To determine manufacturer of parts, refer to Parts List, Cross Index Mfr. Code Number to Manufacturer.

Also, some electrical parts are selected for a value that provides optimum circuit operation. These parts are identified by "SEL" next to the value on the schematic diagram. Criteria for these SElectable parts are provided in tables adjacent to the schematic diagram on which the part is located.

ORDERING PARTS

When ordering replacement parts from Tektronix, Inc., include the following information:

1. Instrument type.
2. Instrument serial number.
3. A description of the part (if electrical, include circuit number).
4. Tektronix part number.

SOLDERING TECHNIQUES

WARNING

To avoid electric-shock hazard and instrument damage, disconnect the 7904A from the power source before soldering.

The reliability and accuracy of this instrument can be maintained only if proper soldering techniques are used when repairing or replacing parts.

The desoldering and removal of parts is especially critical and should be done only with an antistatic vacuum solder extractor; further, one approved by a Tektronix, Inc., Service Center.

Use wire solder with rosin core, 63% tin, 37% lead. Contact your local Tektronix, Inc. representative or field office for approved solders.

Several circuit boards used in this instrument are multilayer. Conductive paths between the top and bottom board layers may connect with one or any number of inner layers. Once this inner conductive path is broken (due mainly to poor soldering practices) between the layers, the board is unusable and must be replaced. Damage can void the warranty. Multilayer circuit boards in the 7904A include A6-Main Interface, A12-Control Rectifier, A13-Logic, and A14-Trigger Selector.

CAUTION

Only an experienced maintenance person, proficient in the use of vacuum type desoldering equipment, should attempt repair of any board in this instrument.

When soldering on circuit boards or small wiring, use only a 15-watt, pencil-type soldering iron. A higher wattage soldering iron can cause the etched circuit wiring to separate from the board base material, and melt the insulation from small wiring. Always keep the soldering-iron tip properly tinned to ensure the best heat transfer to the solder joint. Apply only enough heat to make a good solder joint. To protect heat-sensitive components, hold the component lead with a pair of

long-nose pliers between the component body and the solder joint.

The following technique should be used to replace a component on any of the circuit boards.

Touch the tip of the vacuum desoldering tool directly to the solder to be removed.



Excessive heat can cause the etched circuit wiring to separate from the board base material.

Never allow the solder extractor to remain on the board for more than three seconds. Solder wick, spring-actuated or squeeze-bulb solder suckers, and heat blocks (for multi-pin components) must not be used. Damage can void the warranty.

NOTE

Some components are difficult to remove from the circuit boards due to a bend placed in each lead during machine insertion of the component. The bent leads held the component in position during a flow-solder manufacturing process which soldered all components at once. To make removal of machine inserted components easier, first remove the solder from the joint, then straighten the leads of the components on the back of the circuit board, using a small screwdriver or pliers.

When removing multi-pin components, do not heat adjacent conductors consecutively (see Fig. 4-9). Allow a moment for the circuit board to cool before proceeding to the next pin.

Bend the leads of the replacement components to fit the holes in the circuit board. Insert the leads into the holes in the board, or as originally positioned.

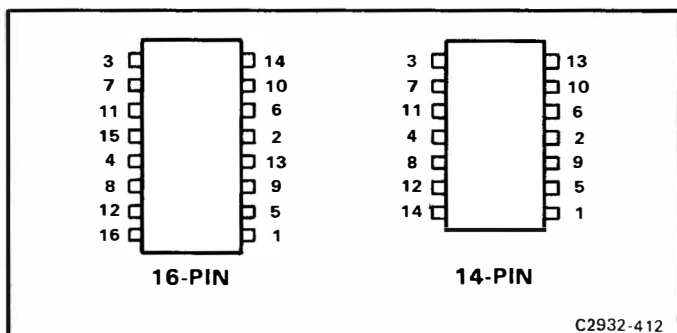

Figure 4-9. Recommended desoldering sequence.

Touch the iron to the connection and apply enough solder to make a firm solder joint.

Cut off any excess lead protruding through the board.

Clean the areas around the solder connection with a flux removing solvent. Be careful not to remove the information printed on the circuit board.

COMPONENT REMOVAL AND REPLACEMENT

WARNING

To avoid electric-shock hazard and instrument damage, always disconnect the instrument from the power source before removing or replacing components or plug-in units.

The exploded-view drawings associated with the Replaceable Mechanical Parts list (located at the rear of this manual) may be helpful in the removal or disassembly of individual components or sub-assemblies.

DISPLAY UNIT KICKSTAND

The Display unit of the 7904A Oscilloscope mainframe is equipped with a kickstand to ease access to interior components of the instrument (see Fig. 4-10). To use the kickstand feature, disconnect the power-cord plug from the power source. Then remove the side and top panels as described under Cabinet Panel Removal. Remove the two screws on each side of the 7904A which connect the two units. This will allow the upper portion of the frame coupling to be pivoted outward. The two units can now be separated at the front of the instrument (the kickstand will hold the units apart). To assemble the units, disengage the kickstand and reverse the disassembly procedure.

POWER-SUPPLY UNIT REMOVAL

The power-supply unit can be slid out of the rear of the 7904A to gain better access to the A13-Logic board, A14-Trigger Selector board, or for power-supply maintenance and troubleshooting. To remove the power-supply unit from the mainframe, first remove the four screws which hold the power-supply unit to the rear frame of the instrument (see Fig. 4-11). Slide the power-supply unit out of the mainframe until it can be set down on the work surface (be sure to guide the interconnecting cables so they do not catch on other parts of the instrument). The power-supply unit remains electrically connected to the rest of the instrument in this position, allowing for troubleshooting. If it is necessary to operate this instrument with the power-

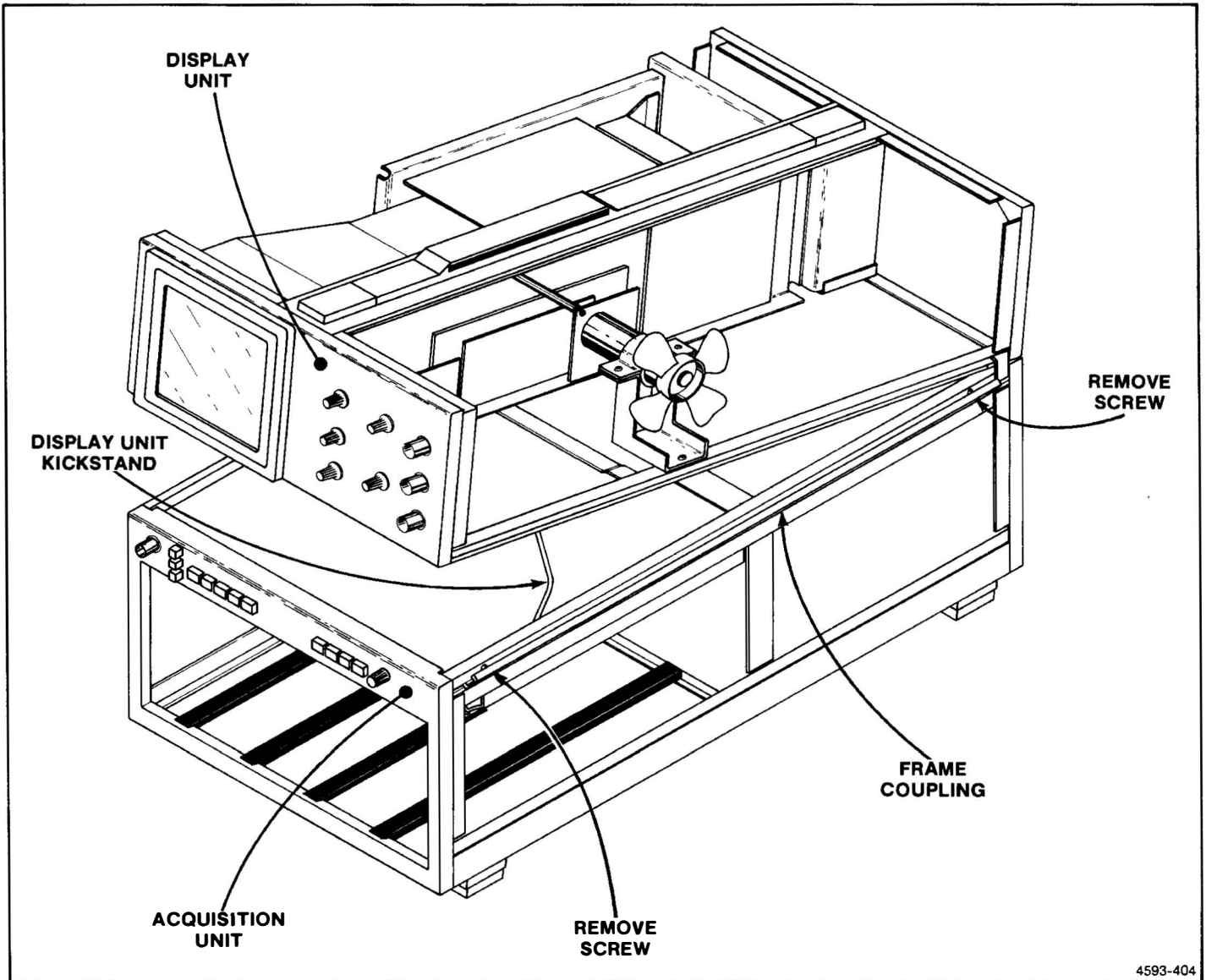

Figure 4-10. Use of Display Unit kickstand.

supply unit removed for a period of time, we recommend that the power-supply unit be secured to the instrument with spacers between the rear frame and the power-supply unit.

Reverse the above procedure when placing the power-supply unit into the mainframe of the instrument; be careful not to pinch the interconnecting cables when replacing the unit. Be sure that all the securing screws are tight enough to hold the power-supply unit properly in place.

Access to Components in the Power-Supply Unit

To reach the components located inside the power-supply unit for maintenance or repair, use the following procedure:

WARNING

Disconnect the instrument from the power source and allow the line storage capacitors to discharge, before removing the power-supply unit cover. The line storage capacitors remain charged with high voltage dc for several minutes after the line power is disconnected unless they are manually discharged. A warning-indicator (neon bulb), located on the A23-Power Supply Inverter board, flashes when this stored voltage exceeds about 80 volts. Do not remove the power-unit cover while this light is flashing.

1. Slide out the power unit as previously described.

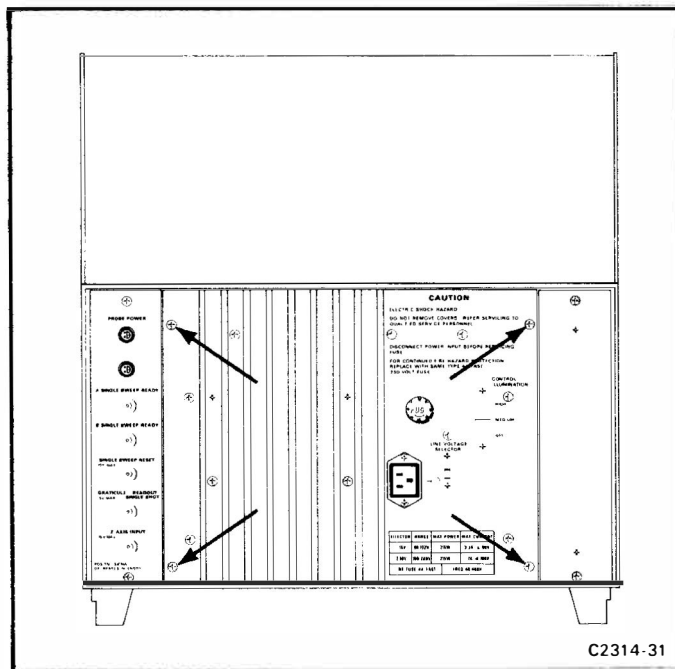

Figure 4-11. Power supply unit securing screws.

2. Remove the four small screws that secure the cover to the rear heatsink.
3. Remove the 9 screws that attach the sides of the cover to the power unit chassis. (Do not remove the four screws from the bottom of the Power Supply Unit.)
4. Disconnect the two coaxial cables (one 4-pin connector) from P40 on the A12-Control Rectifier board.
5. Remove the cover from the power-supply unit.
6. The power-supply unit is now open for maintenance or repair. If the 7904A is to be operated with the cover removed, first reconnect the coaxial cables to the A12-Control Rectifier board.
7. Reverse the order of removal to replace the power-unit cover.

Before performing maintenance or taking resistance measurements in the power-supply unit, manually discharge the line storage capacitors (A23C16 and A23C17) as follows:

1. Remove the protective cover from the power-supply unit following the preceding procedure.
2. Apply a 1.5-kilohm, 2-watt, insulated resistor across the capacitor screws as indicated in Figure 4-5.

CATHODE-RAY TUBE REMOVAL

Remove the cathode-ray tube (crt) as follows:

WARNING

The crt may retain a dangerous electrical charge. Before removing the crt, the anode must be fully discharged by shorting the anode lead from the crt to the chassis. Wait approximately ten minutes and again firmly short this lead to the chassis. Then remove the crt.

Use care when handling a crt. Breakage of the crt causes a high-velocity scattering of glass fragments (implosion). Protective clothing and safety glasses should be worn. Avoid striking the crt on any object which might cause it to crack or implode. When storing a crt, place it in a protective carton or set it face down in a protected location on a smooth surface with a soft mat under the faceplate.

1. Remove the crt base-pin socket from the rear of the crt.
2. Loosen the two screws located above and below the crt base pins until the tension of the springs on these screws is released (access to the 2 screws is through holes in the A20 High-Voltage board). Then, press in upon the screws to be certain that the crt clamp inside the crt shield is loose.
3. Disconnect the two vertical deflection-plate connectors. (The vertical deflection plate connections are from the A18 Vertical Amplifier board by way of the A31-Vertical Flexcon connector.)
4. Disconnect the two horizontal deflection-plate connectors from the top of the crt.
5. Disconnect the two vertical termination connectors from the crt (located directly in front of the vertical deflection plate connectors).
6. Remove the plastic and metal masks which cover the crt bezel.
7. Remove the four screws securing the crt bezel to the front panel. Remove the bezel and disconnect the three-pin camera power connector from the rear of the bezel.
8. Remove the plastic faceplate protector, the graticule light assembly, and the black crt faceplate mask. (The graticule light assembly need not be unsoldered from its leads.)
9. Hold one hand on the crt faceplate and gently push forward on the crt base with the other. Slowly pull

Maintenance—7904A

the crt out from the front of the instrument while guiding the crt anode lead through the holes in the crt shield.

CATHODE-RAY TUBE REPLACEMENT

Replace the cathode-ray tube (crt) as follows:

1. Insert the crt into the shield, guiding the crt anode plug through the holes in the crt shield. Set the crt firmly against the front-panel casting.
2. Clean the crt faceplate, plastic faceplate protector, and the light filter with denatured alcohol.
3. Place the black crt mask over the faceplate. Reconnect the multi-pin connector to the crt bezel (align the arrow on the connector with the arrow on the bezel).
4. Hold the faceplate protector in position and replace the crt bezel, graticule light assembly, light filter frame, and light filter. Firmly tighten the four screws making sure that the light filter is properly aligned.
5. Gently push forward on the crt base to ascertain that the crt is as far forward as possible. Then tighten the two screws beside the crt base until the springs on the screws are fully compressed.
6. Place the crt base-pin socket on the crt base pins.
7. Carefully reconnect the crt neck-pin connectors.
8. Reconnect the crt anode plug.
9. Replace the plastic crt bezel mask.

NOTE

The replacement of the crt will require that the instrument be re-adjusted. Refer to Section 5, Checks and Adjustment.

CIRCUIT BOARDS

If a circuit board is damaged beyond repair, replace the entire board assembly. Part numbers are given in Section 7, Replaceable Electrical Parts, for completely wired boards.

Most of the circuit boards in this instrument are mounted on the chassis; pin connectors are used for electrical interconnection with chassis-mounted components and other circuit boards. Several boards plug onto the rear of the A6-Main Interface board; feed-thru connectors connect the plug-on boards to the A6-Main Interface board.

Chassis-Mounted Boards

Remove and replace all chassis-mounted circuit boards as follows:

1. Disconnect all pin connectors attached to the board, or which connect the board to other parts of the instrument.
2. Remove the securing screws.
3. Remove the chassis-mounted board.
4. Replace chassis-mounted boards in the reverse order of removal. Match the index arrow on the multi-pin connectors to the corresponding arrow on the board. Correct location of the pin connectors is shown on the circuit board illustration in Section 8, Diagrams and Circuit Board Illustrations.

Plug-On Boards

Remove and replace the plug-on boards as follows:

1. Remove the power-supply unit (see Power-Supply Unit Removal) as necessary to gain access to the boards mounted on the rear of the A6-Main Interface board.
2. Disconnect any end-lead coaxial connectors located on the front of the board, or those which pass across a portion of the board.
3. Loosen all of the board's securing screws.
4. Keeping the board parallel to the A6-Main Interface board, gently pull out on the edges of the board until the feed-thru terminals are cleared.
5. To replace a plug-on circuit board, position the board parallel to the A6-Main Interface board so that all feed-thru pins are properly aligned with their sockets.
6. Gently press the circuit board against the mounting surface. Be sure that all feed-thru pins and sockets mate properly.
7. Uniformly tighten the securing screws (recommended torque: four to six inch-pounds).

A5-Mode Switch Circuit Board

Remove or replace the A5-Mode Switch circuit board as follows:



Do not allow solder or solder flux to flow under printed circuit board switches. The printed circuit board is part of the switch contacts, and intermittent switch operation can occur if contaminated.

1. Separate the Display Unit from the Acquisition Unit as previously described under Display Unit Kickstand.
2. Remove the VERT TRACE SEPARATION (B) knob and extension shaft from the circuit board.
3. Disconnect the pin connectors and remove the 5 screws holding the board to the chassis.

NOTE

When removing wires from a circuit board, always tag the wire and the corresponding connection point on the circuit board.

4. Slide the board toward the rear of the instrument until the front-panel pushbuttons clear the chassis.
5. Lift the board from the instrument.
6. Replace the board by reversing the order of removal. Match the index arrow on the pin connectors to the corresponding arrow on the board. Correct location of the pin connectors is shown on the circuit board illustration in Section 8, Diagrams and Circuit Board Illustrations.

A6-Main Interface Circuit Board

Remove and replace the A6-Main Interface circuit board as follows:

1. Remove the plug-in units and the power-supply unit (see Power-Supply Unit Removal).
2. Disconnect all connectors from the A6-Main Interface board. Note the location of the connectors so they can be correctly replaced.
3. Remove the screws from inside each plug-in compartment which hold the plug-in interface connectors to the chassis (see Fig. 4-12).
4. Slide the Main Interface board assembly to the rear of the instrument and remove it.
5. Replace the A6-Main Interface circuit board in the reverse order of removal. Match the index arrow on the pin connectors to the corresponding arrow on the board. Correct location of the pin connectors is shown in the circuit board illustrations in Section 8, Diagrams and Circuit Board Illustrations.

A7/A8/A9/A10/A25/A26-Follower Circuit Boards

Follower circuit boards with four or six interface contacts are used in the plug-in interface connectors to provide optimum signal connections between the plug-in units and the 7904A. Each Follower board is held in place by a spring so that the board can move back and forth within the interface connector to compensate for

length differences between plug-in units. If a contact on a Follower board is damaged, the entire board with contacts and interconnecting cables is replaced as a unit.

Remove a Follower circuit board as follows:

1. Disconnect the instrument from the power source and remove any plug-in units.
2. Remove the power supply unit (see Power Supply Unit Removal).
3. Remove the metal shields in front of the A6-Main Interface board.
4. Disconnect the coaxial leads of the Follower board from the A16-Vertical Channel Switch board, A29-Horizontal Interface or A14-Trigger Selector board. Note the location of the connectors so they may be correctly replaced.
5. Using long-nose pliers, disengage the spring from the Follower board (spring is in front of A6-Main Interface board).
6. Remove the Follower board with interconnecting cables from the rear of the interface connector, through the hole in the A6-Main Interface board.

To replace a Follower circuit board, a folded length of very thin shim stock, as wide as the Follower board, is required to compress the contacts while the board is inserted into the interface connector. Proceed as follows:

1. Hold the Follower board between the ends of the shim stock with the fold directly in front of the contacts. With the shim stock held against the sides of the board, the contacts on the sides of the board should be pressed together.
2. Insert the folded end of the shim stock (with the Follower board) into the rear of the interface connector through the hole in the A6-Main Interface board. When the Follower board contacts are almost fully inserted into the connector, hold the board in place and remove the shim stock through the front of the interface connector while fully inserting the Follower board.
3. Secure the Follower board with the spring.
4. Reconnect the Follower board coaxial leads to the A16-Vertical Channel Switch or A29-Horizontal Interface board and the A14-Trigger Selector board.
5. Replace the power supply unit.
6. Replace the metal shields.

Maintenance—7904A

A11-Fan Motor Circuit Board (SN B039999 & Below)

The exhaust fan and A11-Fan Motor circuit board are removed as a unit. Remove and replace the Fan assembly as follows:

1. Remove one screw which holds the A11-Fan Motor board to the standoff mount.
2. Remove two screws which fasten the fan motor assembly to the mounting bracket.
3. Disconnect the pin connector from the board.
4. Remove the Fan assembly from the instrument.
5. To replace the Fan assembly, place the two screws through the holes in the bracket and secure the fan motor assembly.

6. Replace the pin connector, matching the index arrow with the arrow on the circuit board.
7. Replace the screw which holds the board to the standoff mount.

A22-Low-Voltage Regulator Circuit Board

Remove and replace the A22-Low-Voltage Regulator circuit board as follows:

1. Slide the power-supply unit out of the instrument (see Power-Supply Unit Removal).
2. Disconnect the multi-pin connectors from the board (two of the multi-pin connectors are self-locking; see the discussion on Multi-Pin Connectors in this section). Note the location of the pin connectors so they may be correctly replaced.

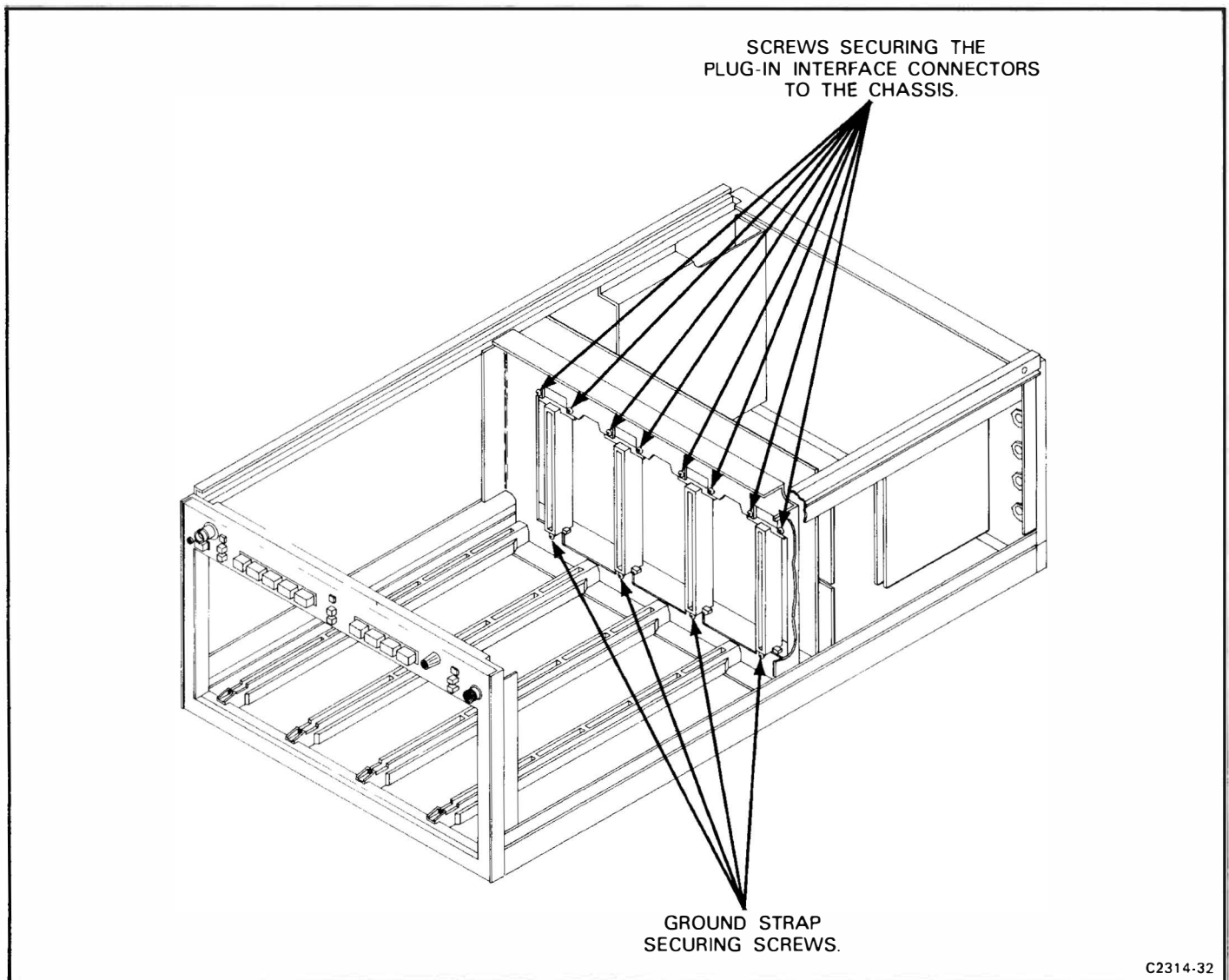

Figure 4-12. Location of securing screws for the A6-Main interface board.

NOTE

If the A22-Low-Voltage Regulator board is to be removed to allow access to other parts of the power-supply unit, proceed with steps 3 and 4 only. If the board is to be removed from the instrument, proceed with steps 3 through 6.

3. Remove the 2 screws located in the access holes under the A22-Low-Voltage Regulator board. These screws secure the chassis.
4. Remove the 4 screws securing the Low-Voltage Regulator chassis to the rear heatsink. Then remove the 2 screws securing the Low-Voltage regulator chassis to the main power supply chassis (located in front of the A22-Low-Voltage Regulator board). Now remove the board and attached chassis.
5. Remove the mounting hardware securing the plastic-cased power transistors to the rear heatsink (see Fig. 4-13). Note the position of the lockwashers so they can be correctly replaced.
6. Remove the 5 securing screws and lift the board with attached power transistors from the chassis.
7. To replace the A22-Low-Voltage Regulator board, first apply a thin coat of silicone grease to the back (mounting surface) of each power transistor.
8. Place the A22-Low-Voltage Regulator board on the chassis. Replace, but do not tighten, the securing screws.
9. Check that the power transistors are aligned with their mounting screws and that the insulating washers are in place between the transistor cases and the rear heatsink.
10. Secure the transistors with the mounting hardware. Do not over-tighten the nuts; recommended torque is four to six inch-pounds.
11. Tighten the screws holding the A22-Low-Voltage Regulator board to the chassis.

WARNING

Handle silicone grease with care. Avoid getting silicone grease in your eyes. Wash hands thoroughly after use.

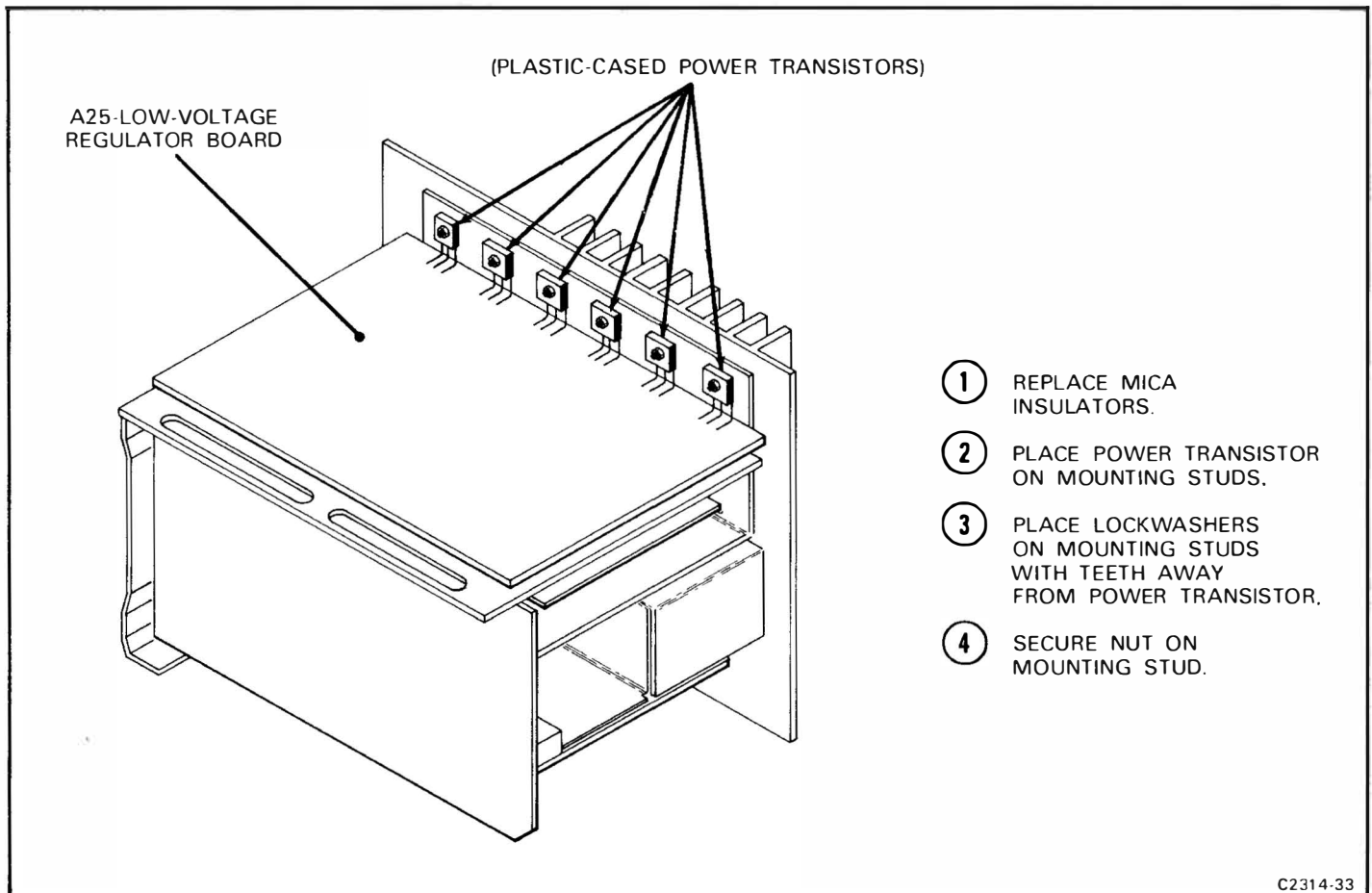

Figure 4-13. Correct placement of power transistor and mounting hardware on rear heatsink.

Maintenance—7904A

12. Install the chassis on the power-supply unit.
13. Connect the multi-pin connectors to the board. Match the index arrow on the pin connectors to the corresponding arrow on the board. Correct location of the pin connectors is shown in the circuit board illustration in Section 8, Diagrams and Circuit Board Illustrations.
14. Replace the power-supply unit in the instrument.

A12-Control Rectifier Circuit Board

An exploded-view drawing of the power-supply unit is given in Section 9, Replaceable Mechanical Parts, at the rear of this manual. To remove the A12-Control Rectifier board, use the following procedure:

1. Slide the power-supply unit out of the instrument (see Power-Supply Unit Removal).
2. Remove the protective cover from the power-supply unit (see Access to Components in the Power Supply Unit).
3. Remove the A22-Low-Voltage Regulator board with attached chassis as previously described.
4. Disconnect the multi-pin connectors from the A12-Control Rectifier board. Note the location of the pin connectors so they can be correctly replaced.
5. Remove the 2 plastic screws which hold the circuit-board shield to the A23-Power-Supply Inverter board.
6. Unsolder the 3 power-transformer leads from the A23-Power-Supply Inverter board. Remove the excess solder from the board pads with a vacuum-type antistatic desoldering tool.
7. Remove the 2 screws connecting the transformer mounting chassis to the power-supply rear heatsink.
8. Remove the 5 securing screws from the A12-Control Rectifier board.
9. Lift the circuit board and attached power transformer from the power-supply unit.
10. To replace the A12 Control Rectifier board, reverse the order of removal. Match the index arrow on the pin connectors to the corresponding arrow on the board. Correct location of the pin connectors is shown on the circuit board illustrations in Section 8—Diagrams and Circuit Board Illustrations.

A23-Power Supply Inverter Circuit Board

An exploded-view drawing of the power-supply unit is given in Section 9, Replaceable Mechanical Parts, at the

rear of this manual. Remove and replace the A23-Power Supply Inverter board as follows:

WARNING

The power-supply unit has been tested at the factory to ensure safe operation. Improper repair of this unit can result in hazardous potentials on the instrument chassis. Do not remove the plate insulator, block insulator, or transistor shield from the heatsink. (See the exploded-view drawing of the power-supply unit for the location of the components.)

1. Slide the power-supply unit out of the instrument (see Power-Supply Unit Removal).
2. Remove the protective cover from the power-supply unit (see Access to Components in Power-Supply Unit).
3. Remove A12-Control Rectifier board using the previous procedure.
4. Remove the 5 securing screws from A23-Power Supply Inverter board.
5. Unsolder the 5 line-input leads from the circuit board. Remove the excess solder from these circuit board pads with a vacuum-type anti-static desoldering tool.
6. Remove the two power transistors by removing the securing screws and pulling the transistors from the ceramic heatsinks.
7. Remove the A23-Power Supply Inverter board from the power-supply unit.
8. To replace the A23-Power Supply Inverter board, reverse the order of removal. Match the index arrow on the pin connectors to the corresponding arrow on the board. Correct location of the pin connectors is shown on the circuit board illustration in Section 8, Diagrams and Circuit Board Illustrations.

PLUG-IN INTERFACE CONNECTORS

The individual contacts of the plug-in interface connectors can be replaced. However, we recommend replacing the entire A6-Main Interface board if a large number of the contacts are damaged. An alternative solution is to refer the maintenance of the damaged A6-Main Interface board to your local Tektronix Field Office. Use the following procedure to remove and replace an individual contact of the plug-in interface connectors:

NOTE

The plug-in interface contacts which are mounted on the Follower circuit boards cannot be replaced. A Follower board with contacts and interconnecting cables is replaced as a unit. See Circuit Boards.

1. Remove the A6-Main Interface circuit board from the instrument as previously described.
2. Snap the white plastic connector cover off the side of the damaged plug-in interface connector.
3. Unsolder and remove the damaged contact.
4. Install the replacement contact. Carefully position it to fit against the connector body.
5. Snap the white plastic connector cover back onto the plug-in interface connector. Check that the replaced contact is aligned with the other contacts.
6. Replace the A6-Main Interface board.

DELAY LINE REMOVAL

The vertical delay line is carefully matched at the factory. Therefore, it is not recommended that repair be attempted in the field. Instead, contact your local Tektronix Field Office.

SEMICONDUCTORS

Semiconductors should not be replaced unless actually defective. If removed from their sockets during routine maintenance, return them to their original sockets. Unnecessary replacement of semiconductors may affect the adjustment of the instrument. When semiconductors are replaced, check the operation of circuits which may be affected.

WARNING

To avoid electric shock hazard, always disconnect the 7904A from the power source before removing or replacing components.

Replacement semiconductors should be of the original type or a direct replacement. The lead configurations of semiconductors used in this instrument are shown earlier in Figure 4-2. Some plastic case transistors have lead configurations which do not agree with those shown. If a replacement transistor is made by a different manufacturer than the original, check the manufacturer's basing diagram for correct basing. All transistor sockets in this instrument are wired for standard basing as used for metal-cased transistors. When removing soldered-on transistors, use an anti-

static vacuum solder extractor (see Soldering Techniques in this section) to remove the solder from the circuit board pads. Transistors which have heat radiators or are mounted on the chassis use silicone grease to increase heat transfer. Replace the silicone grease on both sides of the insulating washer when replacing these transistors.

WARNING

Handle silicone grease with care. Avoid getting the silicone grease in your eyes. Wash hands thoroughly after use.

To replace one of the power transistors mounted on the heatsink at the rear of the power-supply unit, first remove the mounting hardware. Then, unsolder and remove the defective transistor. When replacing the transistor, be sure to install the insulating washer between the transistor and the heatsink (use silicone grease as previously described). Tighten the mounting nut just tight enough to hold the transistor in place. Then solder the replacement transistor to the A22-Low-Voltage Regulator board.

An extracting tool should be used to remove the in-line integrated circuits to prevent damaging the pins. This tool is available from Tektronix, Inc.; order Tektronix Part 003-0619-00. If an extracting tool is not available, use care to avoid damaging the pins. Pull slowly and evenly on both ends of the integrated circuit. Try to avoid disengaging one end from the socket before the other end.

Hypcon Connectors

The hypcon (hybrid-printed connector) is a precision-made connector designed to provide low loss electrical and/or thermally efficient connection between the printed circuit board and hybrid integrated circuit. An exploded view of the Hypcon connector is shown in Figure 4-14. Care must be taken, when replacing the hybrid IC's not to touch the elastomer gold-plated contacts with your fingers or to use a cleaner which will degrade contact reliability. If it becomes necessary to use a cleaning solvent near the connector when replacing adjacent (within 1/2") circuit board components, the Hypcon connector and hybrid IC should be removed.

IMPORTANT: Remove all traces of solder flux or foreign material contamination from the circuit board contact area before replacing the connector. Contamination usually takes place during the soldering and cleaning process. Even when the soldering is done carefully, flux, oil, or other contaminants can be carried under the connector during the cleaning operation. When the solvent evaporates, nonconductive contaminants may remain on or near the contact interfaces.

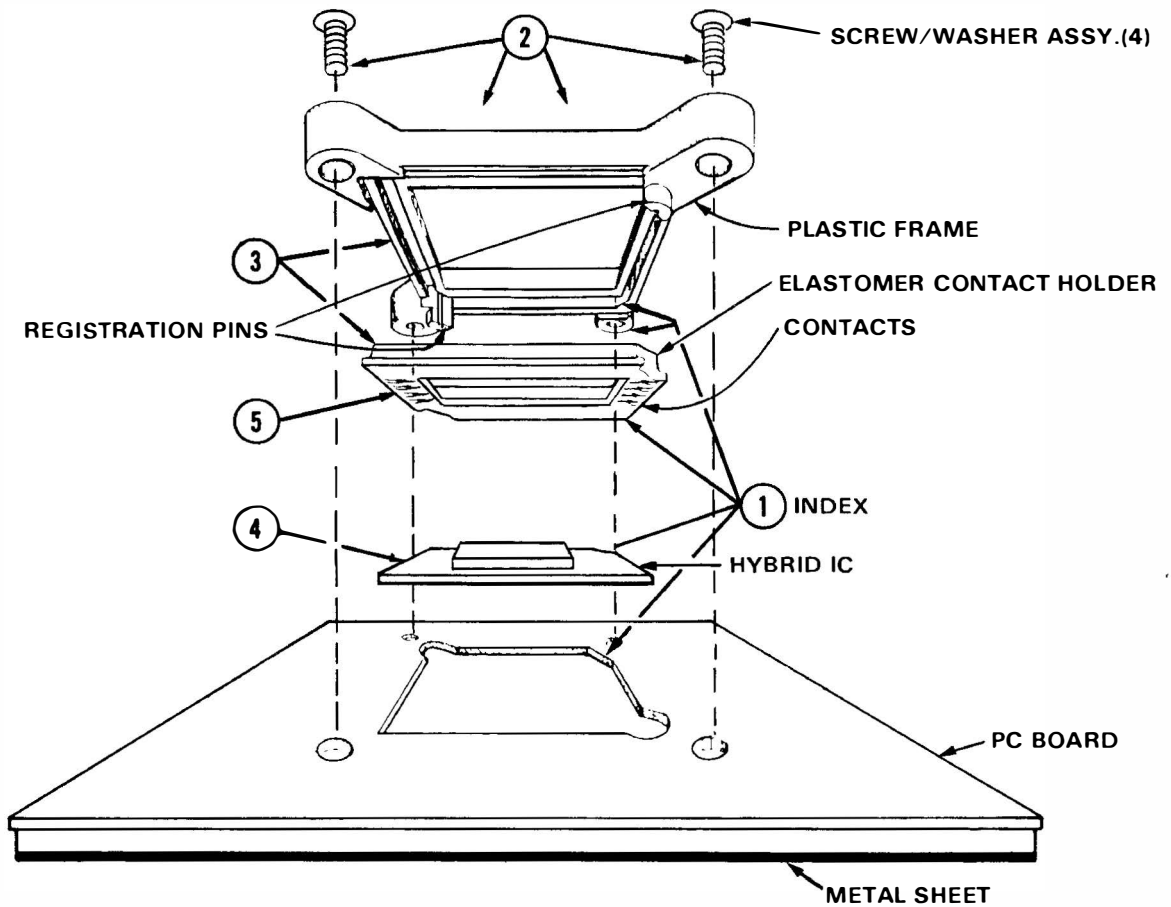

EXPLODED VIEW OF HYPCON CONNECTOR

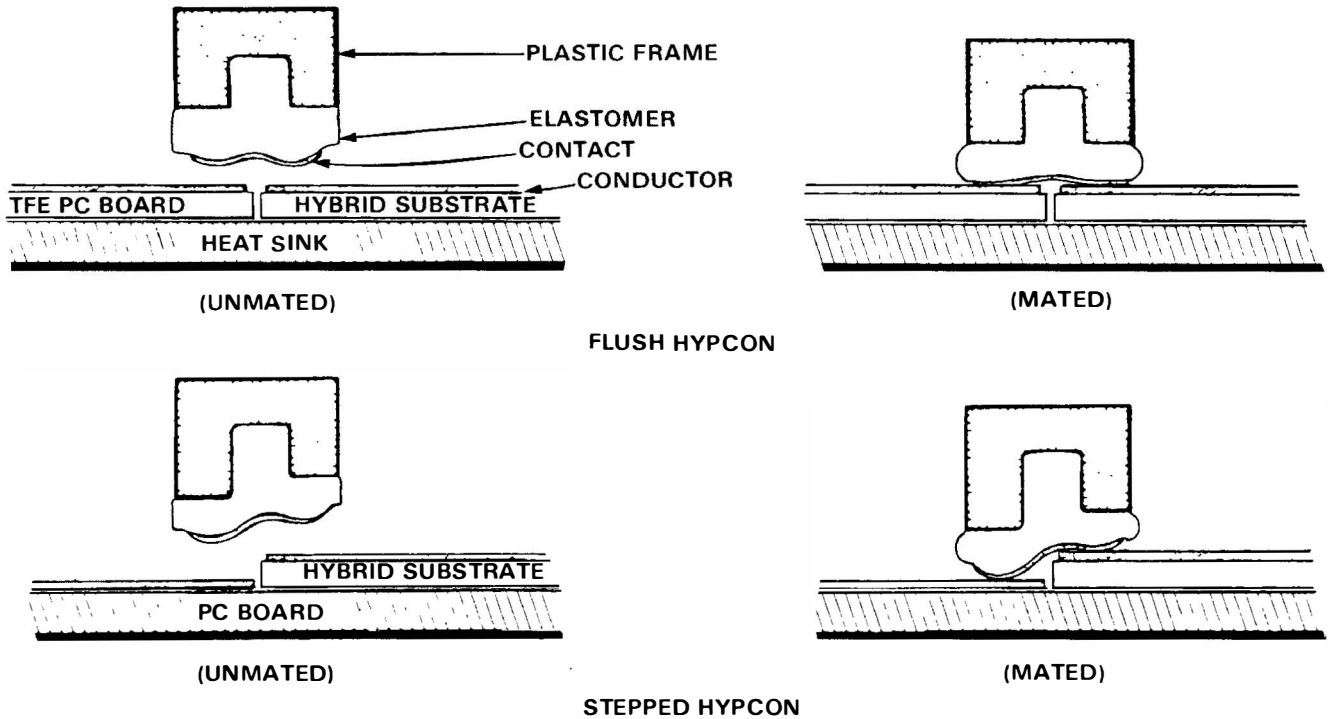

C2316-23

Figure 4-14. HYPCON assembly removal and replacement.

DISASSEMBLY AND REMOVAL

- ① Note index on circuit board (arrow, triangle, or dot) and HYPCON plastic frame (pointed mounting ear).
- ② Unscrew and remove the 4 screw/washer assemblies. Where the HYPCON connector serves to heatsink the hybrid to the chassis, 2 of the 4 screws are longer. Note the location of the yellow tinted screws for proper replacement.
- ③ Lift HYPCON connector from board.
- ④ Note index location of hybrid and remove from board with tweezers.
- ⑤ Note index location of elastomer contact holder and remove by grasping a corner of the contact holder with tweezers and lifting up. Do not touch the gold-plated contacts with your fingers.

REASSEMBLY AND REPLACEMENT

Grasp corner of elastomer contact holder with tweezers and place in plastic frame slot being careful to match the flat contact holder with the flat frame corner. Place a clean plastic envelope over finger and press with finger to seat contact holder into the frame. The contact holder must be evenly seated on all four sides.

Flush HYPCON: Match hybrid flat corner with board receptable flat corner and place hybrid in receptable. Match pointed mounting ear of HYPCON connector with flat corner of receptacle and guide registration pins into the board hold.

Stepped HYPCON: Using tweezers, match the hybrid corner index with the elastomer contact holder index and insert between the registration pins. Turn the assembly over, grasp the hybrid "hat" with the tweezers, and guide the registration pins into the board holes. Match the plastic frame pointed mounting ear with the circuit board arrow.

Insert mounting hardware and apply 2 inch-pounds of torque to secure the connector assembly.

C(2316-23B) 2314-3B

Figure 4-14 (cont). HYPCON assembly removal and replacement.

Maintenance—7904A

The cleaning process (either hand cleaning with a solvent or machine cleaning in an automatic detergent wash) is not recommended for boards containing Hypcon connectors.

If a component adjacent to a Hypcon connector must be replaced, the following steps are recommended:

1. Remove the hybrid IC and Hypcon connector (see Disassembly and Removal instructions) before any soldering or cleaning and store in a dirt-free covered container. When several hybrids and Hypcon connectors are to be removed, keep parts together and replace as sets; do not interchange parts.
2. Hand soldering:
 - a. Use small diameter solder (0.030inch-0.040inch).
 - b. Use low wattage soldering irons (15-20 watts).
 - c. Use care with solder amount and placement.
3. Remove solder flux and contact contamination with isopropyl alcohol, denatured ethyl alcohol, or a Freon TF cleaner such as Spray-On #2002.
4. Flush the hybrid and Hypcon connector mounting area with isopropyl alcohol. Do not scrub with a cotton-tipped applicator, as cotton fibers will adhere to edges and surfaces of contact areas and cause open or intermittent connections. The elastomer should be examined under light for dust, hair, etc., before it is re-installed. If the etched circuit board surfaces require more cleaning, scrub with a soft rubber eraser and blow or vacuum clean while dusting the surface with a small clean brush.
5. If the hybrid IC and elastomer contact holder are contaminated, clean by flushing or spraying with alcohol and oven dry at 50° C. Do not scrub with a cotton-tipped applicator or similar device. If the contact holder is excessively contaminated, replace it with a new one.

Two inch-pounds of torque should be applied to the mounting screws to secure the Hypcon to the circuit board.

Make sure that the elastomer is properly seated in the contact holder before remounting the assembly to circuit board. Exercise care when mounting the frame—elastomer contact holder—hybrid IC assembly to the circuit board to prevent misalignment between the connector and board.

CAUTION

Because of the close tolerances involved, special care must be taken to assure correct index alignment of each Hypcon part during reassembly. Failure to do so can result in a cracked hybrid substrate. See Figure 4-14 for index locations.

If your instrument contains both the flush and stepped type of Hypcon connectors be careful not to mix the elastomer contact holders during reassembly. The flush Hypcon connectors have green elastomer contact holders and the plastic frame is marked FLUSH. The stepped Hypcons have neutral-colored elastomer contact holders with a slight ridge or step on the contact surface; the large frames are marked STEPPED. The registration pins on the stepped plastic frame are slightly longer than those on the flush frame. The elastomer contact holder in the small stepped connectors is indexed differently than the large connectors. Look for a small gold arrow in one corner of the holder instead of a flat corner. Match this corner arrow with the pointed corner of the plastic frame. Give close attention to this indexing, as it is easy to insert the elastomer contact holder incorrectly.

Differences also exist between the large flush and large stepped Hypcon circuit board receptacles. Figure 4-14 shows the cross-sectional differences which must be observed when working with an instrument that contains both types of Hypcon connectors.

CAUTION

Damage to the elastomer contact holder can result if the connectors are not mated properly with the board receptacle.

When replacing the hybrid, insert it into the board opening and then position the Hypcon connector in the board registration holes for perfect alignment. The outer portion of the hypcon frame should be flush with the circuit board before the four mounting screws are tightened. Avoid touching the hybrid and elastomer contact holder with your fingers; finger oils can degrade reliability.

A procedure for removal and replacement is included in Figure 4-14.

Hybrid substrate contact numbers 1 and 20 are printed on the substrate at the index corner. See Figure 4-2, Semiconductor lead configurations.

INTERCONNECTING PINS

Two methods of interconnection are used in this instrument to electrically connect the circuit boards with other boards and components. When the interconnection is made with a coaxial cable, a special end-lead connector plugs into a socket on the board. Other interconnections are made with a pin soldered into the board. Two types of mating connectors are used for these interconnecting pins. If the mating connector is mounted on a plug-on circuit board, a special socket is soldered into the board. If the mating connector is on the end of a lead, an end-lead pin connector is used which mates with the interconnecting pin. The following information provides the removal and replacement procedure for the various types of interconnecting methods.

Coaxial-Type End-Lead Connectors

Replacement of the coaxial-type end-lead connectors requires special tools and techniques; only experienced maintenance personnel should attempt to remove or replace these connectors. We recommend that the damaged cable or wiring harness be replaced as a unit. For cable or wiring harness part numbers, see Section 9, Replaceable Mechanical Parts. An alternative solution is to refer the replacement of the defective connector to your local Tektronix Field Office or representative. Figure 4-15 gives an exploded view of a coaxial end-lead connector assembly.

Circuit-Board Pins

A circuit-board pin replacement kit (including necessary tools, instructions, and replacement pins with attached ferrules) is available from Tektronix, Inc. Order Tektronix Part 040-0542-00. Replacing circuit-board pins on multi-layer boards is not recommended. (The multi-layer boards in this instrument are listed under Soldering Techniques in this section.)

To replace a damaged pin, first disconnect any pin connectors. Then remove the solder from the connection using an anti-static vacuum-type desoldering tool (see Soldering Techniques). Remove the damaged pin from the board with a pair of pliers, leaving the ferrule (see Fig. 4-16) in the circuit board if possible. If the ferrule remains in the circuit board, remove the spare ferrule from the replacement pin and press the new pin into the hole in the circuit board. If the ferrule is removed with the damaged pin, clean out the hole using an anti-static vacuum-type desoldering tool and a scribe. Then press the replacement pin, with attached spare ferrule, into the circuit board. Position the replacement pin in the same manner as the original. Solder the pin to the both sides of the circuit board. If the original pin was bent at an angle to mate with a connector, carefully bend the new pin to the same angle. Replace the pin connector.

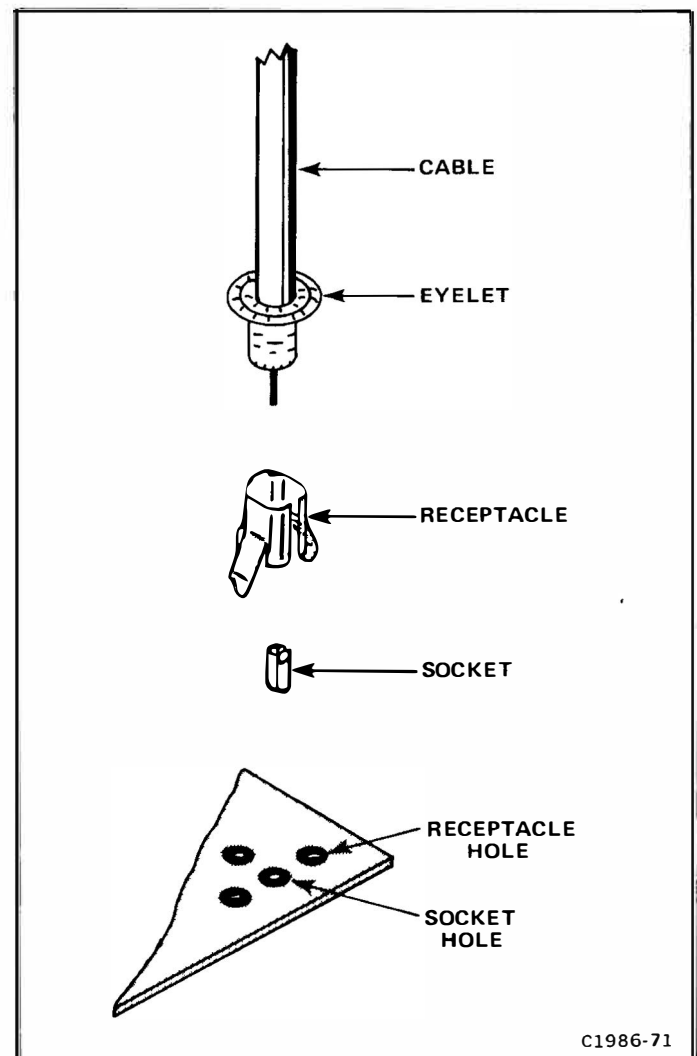

Figure 4-15. Coaxial end-lead connector assembly.

Circuit-Board Pin Sockets

The pin sockets on the circuit boards are soldered to the back of the board. To remove or replace one of these sockets, first unsolder the pin (use an anti-static vacuum-type desoldering tool to remove excess solder). Then straighten the tabs on the socket and remove the socket from the board. Place the new socket in the circuit board hole and press the tabs down against the board. Solder the tabs of the socket to the circuit board; be careful not to get solder inside the socket.

CAUTION

The spring tension of the pin sockets ensures a good connection between the circuit board and the pin. This spring tension can be destroyed by using the pin sockets as a connecting point for spring-loaded probe tips, alligator clips, etc.

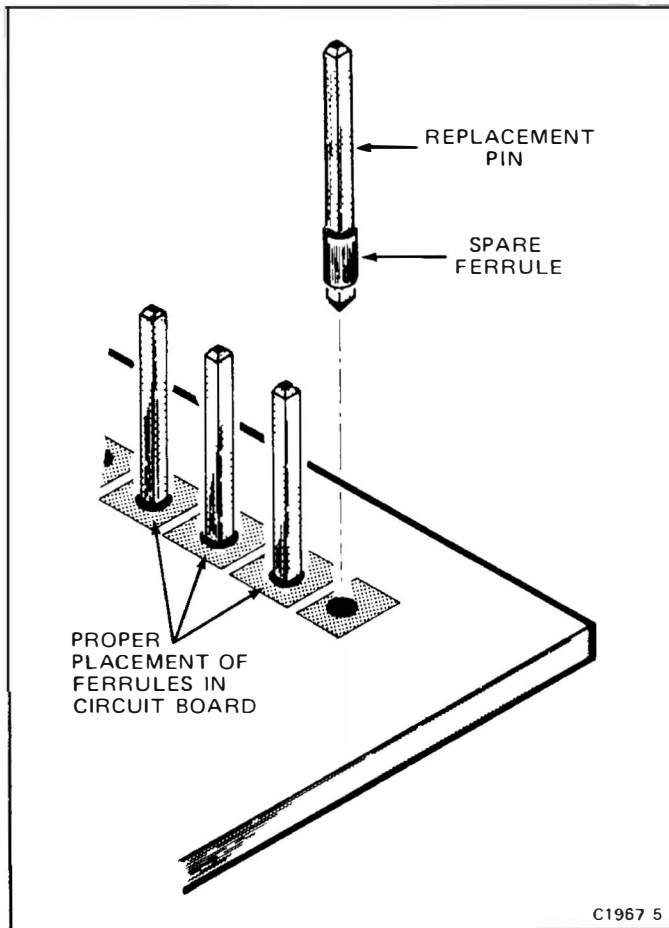

Figure 4-16. Exploded view of circuit-board pin and ferrule.

Multi-Pin Connectors

The pin connectors used to connect the wires to the interconnecting pins are clamped to the ends of the associated leads. To remove or replace damaged multi-pin connectors, remove the old pin connector from the end of the lead and clamp the replacement connector to the lead.

NOTE

Some multi-pin connectors are equipped with a special locking mechanism. These connectors cannot be removed by pulling on the wire(s). To remove the connectors from the pin(s) grasp the plastic holder and pull.

To remove an individual wire from the holder insert a scribe in the hole on the side of the holder and slide the extended portion under the holder. This will allow the wire to be removed from the holder.

Some of the pin connectors are grouped together and mounted in a plastic holder; the overall result is that these connectors are removed and installed as a multi-pin connector (see Troubleshooting Aids). If the

individual end-lead pin connectors are removed from the plastic holder, note the order of the individual wires for correct replacement into the holder.

PUSHBUTTON SWITCHES

The pushbutton switches used on the 7904A Oscilloscope mainframe are circuit board mounted. First remove the associated circuit board following the procedure given under Circuit Boards in this section. Figure 4-17 gives removal and replacement instructions for the pushbutton switch assemblies mounted on the A5-Mode Switch Board.

Pushbutton switches mounted on the A1-Front-Panel and the A2-Display Control boards are soldered onto the circuit boards. Use the soldering methods given under Soldering Techniques (in this section) to replace these switches.

GRATICULE LIGHT BULBS

To remove or replace the graticule light bulbs, first remove the plastic crt mask, light filter, and metal light shield. Pull on the white tabs to remove the graticule lamp assembly. Unsolder the base of the damaged bulb assembly from the A30-Graticule Lights board and pull the bulb out of the circuit board. Reverse the order of removal for replacement.

POWER TRANSFORMER

Replace the power transformer only with a direct replacement Tektronix transformer. Remove and replace the power transformer as follows:

1. Remove the A12-Control Rectifier board as described under Circuit Boards in this section.
2. Unsolder the remaining transformer leads from the A12-Control Rectifier board. Remove the excess solder from the circuit-board pads (see Soldering Techniques). Note the position of the transformer leads so they may be correctly replaced.
3. Remove two screws securing A12C154 and remove the metal-cased capacitor from the circuit board.
4. Remove 4 screws securing the transformer to the mounting bracket and remove the transformer.
5. Place the new transformer in position and solder the leads to the A12-Control Rectifier circuit-board pads.
6. Attach the transformer to the bracket with 4 screws.
7. Secure the metal-cased capacitor to the A12-Control Rectifier board with 2 screws.

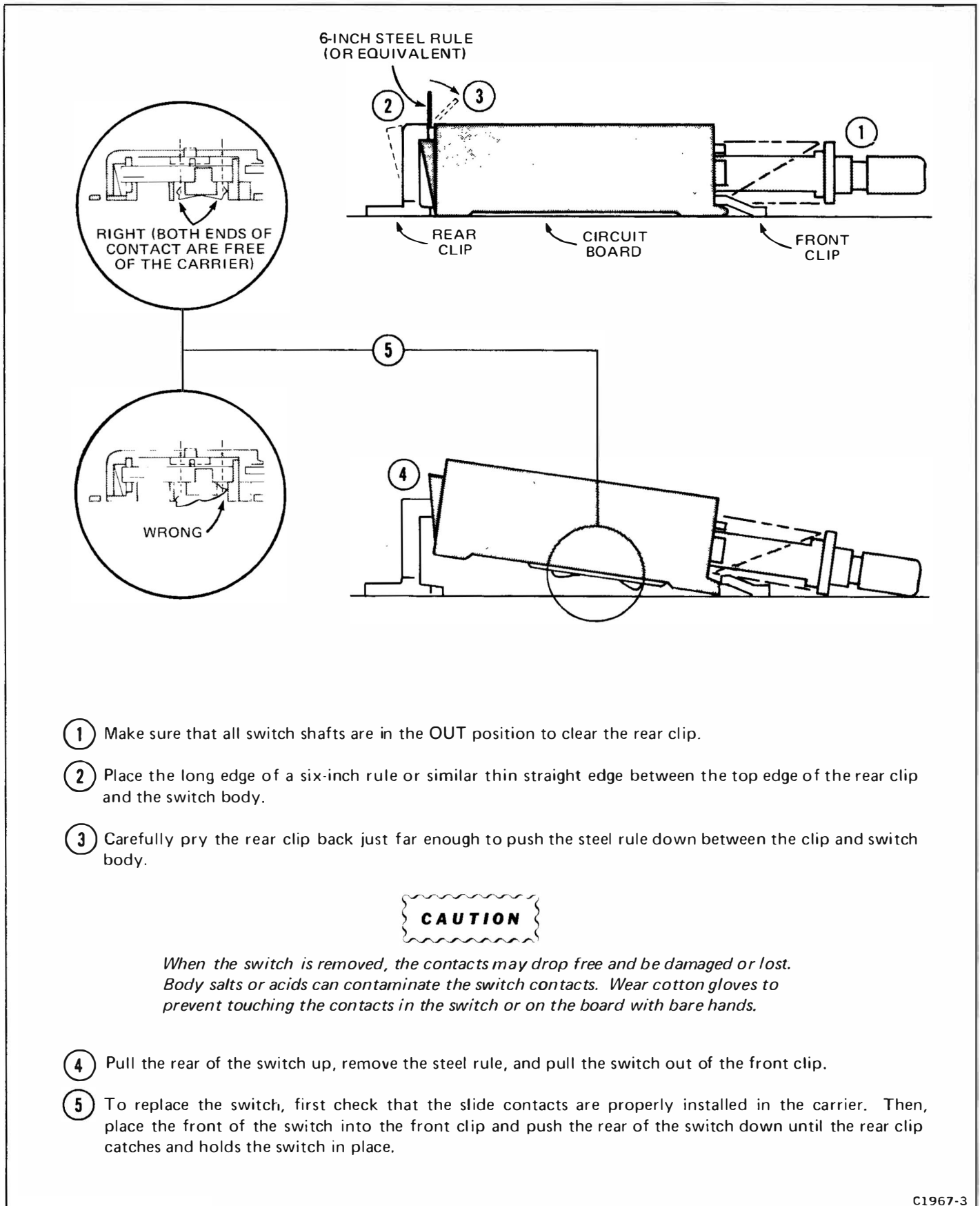

C1967-3

Figure 4-17. Removal procedure for pushbutton switches mounted on the A5 Mode Switch board.

Maintenance—7904A

8. Install the A12-Control Rectifier in the power supply unit as described under Circuit Boards in this section.

LINE FUSE

The line fuse used in this instrument is located on the rear panel of the power-supply unit. Replace the line fuse (F10) only with one of proper type and rating.

NOTE

The line voltage fuse F10 is used for both 110 volt and 220 volt operation. No change in the fuse is necessary when switching the LINE VOLTAGE SELECTOR switch between 110 volts and 220 volts.

ADJUSTMENT AFTER REPAIR

After any electrical component has been replaced, the adjustment of that particular circuit should be checked, as well as the adjustment of any closely related circuits. Since the low-voltage supplies affect all circuits, adjustment of the entire instrument should be checked if component replacements have been made in these supplies or if the power transformer has been replaced. See section 5 for a complete adjustment procedure.

CHECKS AND ADJUSTMENT

This section provides procedures for checking the performance and for adjusting the 7904A. These procedures are designed to compare the performance of this instrument with other measurement instruments of known accuracy to detect, correlate, or eliminate by adjustment, any variation from the electrical specifications. These procedures also verify that the controls function properly.

This section is divided into two parts: Part I—Performance Check is provided for those who wish to verify that this instrument meets the applicable electrical specifications in section 1 without making internal adjustments. Part II—Adjustment and Performance Check provides a procedure that includes adjustments and performance checks in addition to verifying that the controls function properly. The procedures in Part I and Part II are written so that the entire instrument or any major circuit or part of a circuit can be checked or adjusted.

Table 5-1, Checks and Adjustment Procedure Electives, lists the choices available and instructions for performing either complete or partial procedures. Also refer to page 5-2, Using These Procedures, for more detailed information.

TABLE 5-1
Checks and Adjustment Procedure Electives

| Electives | Procedure |
|---|---|
| Functional Check | Perform Power-Up Sequence in Part II—Adjustment and Performance Check. Then proceed sequentially through subsections (A, B, C, etc.) to end. If a functional check only is desired, perform the Operators Checkout Procedure in Section 2. |
| Performance Check Only | Perform Power-Up Sequence in Part I—Performance Check. Then proceed sequentially through subsections (A, B, C, etc.) to end. |
| Complete Check and Adjustment (Part II—Adjustment and Performance Check) | Perform Power-Up Sequence in Part II—Adjustment and Performance Check. Then proceed sequentially through subsections (A, B, C, etc.) to end. |
| Partial Part I—Performance Check or Part II—Adjustment and Performance Check by Subsection (A, B, C, etc.) | Perform Power-Up Sequence for Part I—Performance Check or Part II—Adjustment and Performance Check. Perform the Preliminary Control Settings instructions for the desired subsection. Then proceed sequentially through the procedures in desired subsection. |
| Partial Part I—Performance Check or Partial Part II—Adjustment and Performance Check by Step (A1, A2, B1, B2, etc.) within Subsection (A, B, C, etc.) | Perform Power-Up Sequence for Part I—Performance Check or Part II—Adjustment and Performance Check. Perform the Preliminary Control Settings instructions for subsection (A, B, C, etc.) containing the desired step (A1, A2, B1, B2, etc.). Then proceed through the instructions (a, b, c, etc.) in the desired step. |
| | <p style="text-align: center;">NOTE</p> <p style="text-align: center;"><i>Although a partial adjustment procedure may be done, we recommended that the entire subsection procedure be performed if any adjustments are made.</i></p> |

USING THESE PROCEDURES

NOTE

In these procedures, capital letters within the body of the text identify front-panel controls, indicators and connectors on the 7904A (e.g., READOUT). Initial capitals identify controls, indicators, and connectors (e.g., Position) on associated test equipment (used in this procedure), and adjustments internal to the 7904A (e.g., Vert Gain).

These procedures are divided into subsections by major functional circuits (e.g., A. Power Supply, B. Z-Axis And Display, etc.). The order in which the subsections and procedures appear is the recommended sequence for a complete performance check or adjustment of the instrument.

Each step contains the Setup Conditions which, if applicable, include control settings for this instrument, a test setup illustration, and test equipment control settings. The Setup Conditions are written so that, if

Checks and Adjustment—7904A

desired, each subsection (A,B,C,etc.) or step (A1,A2,B1,B2,etc.) can be performed separately.

A heading system is provided to readily identify the steps (A1,A2,B1,B2,etc.) that contain performance check and/or adjustment instructions. For example, if CHECK is the first word in the title of a step, an electrical specification is checked. If ADJUST is the first word in the title, the step concerns one or more internal adjustments. And if CHECK/ADJUST appears in the title, the step involves electrical specification checks and related adjustments. If EXAMINE is the first word in the step title, the step concerns measurement limits that indicate whether the instrument is operating properly; these limits are not to be interpreted as electrical specifications.

The alphabetical instructions under each step (a,b,c,etc.) may contain CHECK, EXAMINE, ADJUST, or INTERACTION as the first word of the instruction. These terms are defined as follows:

1. **CHECK**—indicates the instruction accomplishes an electrical specification check. Each electrical specification checked is listed in Table 5-2, Performance Check Summary (see Performance Check Summary discussion for more information).
2. **EXAMINE**—usually precedes an ADJUST instruction and indicates that the instruction determines whether adjustment is necessary. If no ADJUST instruction appears in the same step, the EXAMINE instruction concerns measurement limits that do not have a related adjustment. Measurement limits following the word EXAMINE are not to be interpreted as electrical specifications. They are provided as indicators of a properly functioning instrument and to aid in the adjustment process.
3. **ADJUST**—describes which adjustment to make and

the desired result. We recommend that the adjustments not be made if a previous CHECK or EXAMINE instruction indicates that no adjustment is necessary.

4. **INTERACTION**—indicates that the adjustment described in the preceding instruction interacts with other circuits. The nature of the interaction is described and reference is made to the step(s) affected.

PERFORMANCE CHECK SUMMARY

Table 5-2, Performance Check Summary, lists the electrical specifications that are checked in Part I and Part II of this section. Table 5-2 is intended to provide a convenient means for locating the procedures in Part I and Part II that check and/or adjust the instrument to meet the applicable electrical specifications. For example: If the A22 LV Regulator board has been repaired or replaced, use Table 5-2 to locate the electrical specifications affected by the repair or replacement. Then, note the title of the procedure in Part I or Part II in which those specifications are checked and/or adjusted. Use the index provided at the front of Part I and Part II to determine the page number of the desired procedures.

AUX. Z-AXIS CHECK

- a. Install a dual time-base unit into the horizontal compartment.
- b. Set the time-base as follows:

| | |
|------------------|-----------------------|
| Time/Div | 1 ms |
| Dly'd Time/Div | .1 ms |
| Delay Time Mult | 5.0 |
| Dly'd Trig Level | Runs After Delay Time |
- c. **CHECK**—for approximately 1 division of intensified trace in the middle of the screen.

**TABLE 5-2
Performance Check Summary**

| Characteristics | Performance Requirements | Part I Performance Check Procedure Title | Part II Adjustment and Performance Check Procedure Title |
|--|---|--|---|
| VERTICAL SYSTEM | | | |
| Deflection Factor | Compatible with all 7000-Series plug-in units. | E2. Check Vertical Amplifier Gain. | F3. Check/Adjust Vertical Amplifier Gain. |
| Difference Between Vertical Compartments | 1% or less. | | |
| Low-Frequency Linearity | 0.1 div or less compression or expansion of a center-screen 2 div. signal positioned anywhere vertically within the graticule area. | E3. Check Vertical Low-Frequency Linearity. | F4. Check Vertical Low-Frequency Linearity. |
| Frequency Response | Varies with plug-in unit selected. See 7904A Oscilloscope Vertical System Specification, Table 1-7. | E4. Check Vertical Amplifier 500 MHz Gain. | F8. Check Vertical Amplifier 500 MHz Gain. |
| With 7A29 Amplifier Unit | 3 dB down at 500 MHz. | | |

TABLE 5-2 (CONT)
Performance Check Summary

| Characteristics | Performance Requirements | Part I Performance Check Procedure Title | Part II Adjustment and Performance Check Procedure Title |
|---|--|---|---|
| VERTICAL SYSTEM (CONT) | | | |
| Step Response Rise time (10 to 90%) with 7A29 Amplifier Unit | 700 ps or less. | Satisfactory performance substantiated by Frequency Response check "F8. Check Vertical Amplifier 500 MHz Gain." | |
| Isolation Between Vertical Compartments (8 Div Signal) LEFT, RIGHT, ALT Modes | At least 160:1 from dc to 100 MHz and at least 80:1 from 100 MHz to 500 MHz. | E5. Check Vertical Channel Isolation. | F9. Check Vertical Channel Isolation. |
| Delay Line | Permits viewing the leading edge of triggering signal. | Checked throughout procedure when single pulse is displayed on crt. | |
| Difference in Signal Delay Between Vertical Compartments | 100 ps or less. | Does not normally require customer verification. Satisfactory operation is substantiated at the factory. | |
| Vertical Display Modes | Selected by front-panel VERTICAL MODE Switch. | E6. Check Vertical Display Modes. | F10. Check Vertical Display Modes. |
| LEFT | Left Vertical unit displayed. | | |
| ALT | Display alternates between Left and Right Vertical units at rate determined by Horizontal plug-in unit(s). | | |
| ADD | Display is algebraic sum of Left and Right Vertical units. | | |
| CHOP | Display chops between Left and Right Vertical units asynchronously to Horizontal plug-in unit(s). | | |
| RIGHT | Right Vertical unit displayed. | | |
| SLAVED ALT | Slaved Alt operation occurs if: (1) VERT MODE switch is set to ALT, (2) HORIZ MODE switch is set to ALT or CHOP, (3) Time-base unit is installed in each Horizontal compart- ment, and (4) Time-base unit installed in A HORIZ compart- ment operates in slaved mode. When in slaved alt operation the display alternates between: (1) the trace pro- duced by the LEFT VERT unit displayed at the sweep rate of B time-base unit and (2) the trace produced by | | |

TABLE 5-2 (CONT)
Performance Check Summary

| Characteristics | Performance Requirements | Part I Performance Check Procedure Title | Part II Adjustment and Performance Check Procedure Title | | | | | | | |
|--|---|--|--|-----------|----------------|------|------|------------------|------------------|-----------------|
| VERTICAL SYSTEM (CONT) | | | | | | | | | | |
| Vertical Display Modes (cont) SLAVED ALT (cont) | the RIGHT VERT unit displayed at the sweep rate of the A time-base unit. NOTE <i>The VERT TRACE SEP (B) control is inoperative in slaved alternate mode.</i> | E6. Check Vertical Display Modes. | F10. Check Vertical Display Modes. | | | | | | | |
| VERTICAL TRACE SEPARATION (B) | Positions "B" trace at least 4 div. above and below "A" trace, when 7904A operates in ALT or CHOP horizontal modes. See note above concerning slaved alternate VERT MODE. | E7. Check Vertical Trace Separation (B) Operation. | F11. Check Vertical Trace Separation (B) Operation. | | | | | | | |
| TRIGGERING | | | | | | | | | | |
| A and B TRIGGER SOURCE | Selected by front-panel switches. Lights behind the pushbuttons are illuminated to indicate the trigger source. | C3. Check Trigger Selector Operation. | D5. Check Trigger Selector Operation. | | | | | | | |
| VERT MODE | <p>The trigger source is controlled by the Vert Display Mode selection. The source is shown by the illumination of the LEFT and RIGHT trigger source buttons. The source follows (is same as) the Vert Display with the following two exceptions:</p> <table border="1" data-bbox="459 1444 810 1717"> <thead> <tr> <th data-bbox="459 1444 647 1516">VERT MODE</th> <th data-bbox="647 1444 810 1516">TRIGGER SOURCE</th> </tr> </thead> <tbody> <tr> <td data-bbox="459 1516 647 1575">CHOP</td> <td data-bbox="647 1516 810 1575">LEFT</td> </tr> <tr> <td data-bbox="459 1575 647 1717" rowspan="2">SLAVED ALTERNATE</td> <td data-bbox="647 1575 810 1642">RIGHT for A TRIG</td> </tr> <tr> <td data-bbox="647 1642 810 1717">LEFT for B TRIG</td> </tr> </tbody> </table> <p>See Vertical Display Modes, under VERTICAL SYSTEM in this table, for slaved alternate operation.</p> | | | VERT MODE | TRIGGER SOURCE | CHOP | LEFT | SLAVED ALTERNATE | RIGHT for A TRIG | LEFT for B TRIG |
| VERT MODE | TRIGGER SOURCE | | | | | | | | | |
| CHOP | LEFT | | | | | | | | | |
| SLAVED ALTERNATE | RIGHT for A TRIG | | | | | | | | | |
| | LEFT for B TRIG | | | | | | | | | |
| LEFT | Trigger source: LEFT vertical unit. LEFT trigger source button illuminated. | | | | | | | | | |

TABLE 5-2 (CONT)
Performance Check Summary

| Characteristics | Performance Requirements | Part I Performance Check Procedure Title | Part II Adjustment and Performance Check Procedure Title |
|--|--|---|---|
| TRIGGERING (CONT) | | | |
| A and B TRIGGER SOURCE (cont) RIGHT | Trigger source: RIGHT vertical unit. RIGHT trigger source button illuminated. | C3. Check Trigger Selector Operation. | D5. Check Trigger Selector Operation. |
| HORIZONTAL SYSTEM | | | |
| Deflection Factor | Compatible with all 7000-Series plug-in units. (See Plug-In Incompatibilities in Table 1-6.) | Does not normally require customer verification. Satisfactory operation is substantiated when checked with the Signal Standardizer Calibration Fixture. | |
| Gain Differences Between Horizontal Compartments | 1% or less. | D2. Check Horizontal Gain And Low-Frequency Linearity. | E4. Check/Adjust Horizontal Gain and Low Frequency Linearity. |
| DC Linearity | 0.05 division or less error at each graticule line after adjusting for no error at the second and tenth graticule lines. | | |
| Fastest Calibrated Sweep Rate | 500 ps/division. | D3. Check High-Frequency Timing. | E6. Check/Adjust High-Frequency Timing. |
| Horizontal Display Modes | A: A horizontal unit only. ALT: Dual-sweep, alternates between horizontal units. CHOP: Dual-sweep, chops between horizontal units. B: B horizontal unit only. | Checked in the Operators Checkout Procedure in Section 2. | |
| Phase Shift Between Vertical and Horizontal Systems With Option 2 | 2° or less from dc to at least 35 kHz. 2° or less from dc to 1 MHz. | D4. Check X-Y Delay Compensation. | E8. Check/Adjust X-Y Delay Compensation. |
| CALIBRATOR | | | |
| Wave Shape | Square wave. | B4. Check Calibrator Rise Time, Fall Time, and Duty Cycle. | C4. Check Calibrator Rise Time, Fall Time, and Duty Cycle. |
| Polarity | Positive-going with base line at 0 Volt. | B2. Check Calibrator Output Voltage. | C2. Check/Adjust Calibrator Output Voltage. |
| Output Voltage | (Selected by front-panel CALIBRATOR switch.) | | |
| Into $\geq 100\text{ k}\Omega$ | 40 mV, 0.4 V, 4 V. | | |
| Into 50 Ω | 4 mV, 40 mV, 0.4 V. | | |

TABLE 5-2 (CONT)
Performance Check Summary

| Characteristics | Performance Requirements | Part I Performance Check Procedure Title | Part II Adjustment and Performance Check Procedure Title |
|---|---|--|---|
| CALIBRATOR (CONT) | | | |
| Output Current | 40 mA available through CALIBRATOR output with optional bnc-to-current-loop adapter. CALIBRATOR switch must be set to 4 V for calibrated output. | Does not normally require customer verification. Satisfactory operation substantiated at factory. | |
| Amplitude Accuracy (P-P Voltage) | Within 1%. | B2. Check Calibrator Output Voltage. | C2. Check/Adjust Calibrator Output Voltage. |
| Repetition Rate | 1 kHz within 0.25%. | B3. Check Calibrator 1 kHz Repetition Rate. | C3. Check/Adjust Calibrator 1 kHz Repetition Rate. |
| Duty Cycle | 49.8% to 50.2% | B4. Check Calibrator Rise Time, Fall Time, and Duty Cycle. C4. Check Calibrator Rise Time, Fall Time, and Duty Cycle. | |
| Rise Time and Fall Time | 500 ns or less into 100 pF or less. | | |
| SIGNAL OUTPUTS | | | |
| + SAWTOOTH Source | Selected by front-panel switch. A: A HORIZ time-base unit. B: B HORIZ time-base unit. | B5. Check A and B Sawtooth Output Signals. | C5. Check A and B Sawtooth Output Signals. |
| Polarity | Positive-going with baseline at 0 V, within 1 V into 1 MΩ. | | |
| Output Voltage Rate of Rise Into 50 Ω | 50 mV/unit of time selected by time-base unit time/div switch, within 15%. 100 ns/div maximum sweep rate. | Does not normally require customer verification. Satisfactory operation substantiated at factory. | |
| Into 1 MΩ | 1 V/unit of time selected by time-base unit time/div switch, within 10%. 1 μs/div maximum sweep rate. | B5. Check A and B Sawtooth Output Signals. | C5. Check A and B Sawtooth Output Signals. |
| + GATE Source | Selected by front-panel switch. A: A Gate, derived from A HORIZ time-base unit main gate. B: B Gate, derived from B HORIZ time-base unit main gate. | B6. Check A and B Gate Output Signals. | C6. Check A and B Gate Output Signals. |
| Polarity | Positive-going with baseline at 0 V, within 1.0 V into 1 MΩ. | | |

TABLE 5-2 (CONT)
Performance Check Summary

| Characteristics | Performance Requirements | Part I Performance Check Procedure Title | Part II Adjustment and Performance Check Procedure Title | |
|---|--|--|--|--|
| SIGNAL OUTPUTS (CONT) | | | | |
| + GATE (Cont) Output Voltage Into 50 Ω | 0.5 V within 10%. | Does not normally require customer verification. Satisfactory operation substantiated at factory. | | |
| | Into 1 M Ω | B6. Check A and B Gate Output Signals. | C6. Check A and B Gate Output Signals. | |
| | Rise Time into 50 Ω | 5 ns or less. | Does not normally require customer verification. Satisfactory operation substantiated at factory. | |
| | Fall Time into 50 Ω | 15 ns or less. | | |
| SIG OUT | Selected by B TRIGGER SOURCE switch. | C3. Check Trigger Selector Operation. | D5. Check Trigger Selector Operation. | |
| Source | Same as B TRIGGER SOURCE. | | | |
| Output Voltage Into 50 Ω | 25 mV/div of vertical deflection within 25%. | Does not normally require customer verification. Satisfactory operation substantiated at factory. | | |
| | Into 1 M Ω | 0.5 V/div of vertical deflection, within 25% (maximum output: ± 2 V). | | |
| | Bandwidth into 50 Ω | Varies with vertical plug-in selected. See 7904A Oscillo- scope Vertical System Specification in Table 1-7. | | |
| DC Centering | 0 V within 1 V, into 1 M Ω . | C2. Check Vertical Signal Out DC Centering. | D4. Check/Adjust Vertical Signal Out DC Centering. | |
| READOUT DISPLAY | | | | |
| Readout Modes | Internal switch on Readout Board must be in Free-Run position. | F2. Check Readout Modes. | G5. Check Readout Modes. | |
| Free-Run (Not Labeled on Front-Panel) | Continuously displayed (READOUT control not in PULSED position). | | | |
| PULSED | Single-shot operation. | | | |
| Pulsed Source | Selected by front-panel switches. + GATE: Triggered by the trailing edge of the + GATE selected by the front-panel switch. EXT: Controlled through rear- panel remote control connector. MAN: Manual trigger, indepen- dent of other pulse sources. | | | |

**TABLE 5-2 (CONT)
Performance Check Summary**

| Characteristics | Performance Requirements | Part I Performance Check Procedure Title | Part II Adjustment and Performance Check Procedure Title |
|--|---|---|--|
| DISPLAY | | | |
| Graticule Type | Internal, illuminated with variable edge lighting. | Does not normally require customer verification. Satisfactory operation substantiated at factory. | |
| Area Standard Instrument and Option 78 | Eight divisions vertical by ten divisions horizontal. Each division equals one centimeter. | | |
| Option 4, Option 13 | Eight divisions vertical by ten divisions horizontal. Each division equals 0.5 centimeter. | | |
| Phosphor Standard, Option 4 | P31. | | |
| Option 78, Option 13 | P11. | Checked in the Operators Checkout Procedure in Section 2. | |
| Beamfinder | Limits display within graticule area when actuated. | | |
| Geometry | Within 0.1 division; checked over entire 8 × 10 division graticule area. | A2. Check Geometry. | B7. Adjust Trace Alignment Geometry and Focus. |
| CRT Characteristics | Test Conditions: TEKTRONIX C-51 camera with lens set at f/1.2; 1:0.5 Object-to-Image Ratio. Polaroid 20,000 ASA film. | | Does not normally require customer verification. Satisfactory operation is substantiated at the factory. |
| Minimum Photographic Writing Speed (with-out film fogging) | Phosphor | Writing Speed | |
| Standard crt | P31 | ≈1.25 cm/ns | |
| Option 4 | P31 | ≈2 cm/ns | |
| Option 13 | P11 | 4 cm/ns | |
| Option 78 | P11 | 2.5 cm/ns | |
| Exposure Defects | With Intensity and Graticule Illumination controls fully counterclockwise, open the camera shutter for 5 minutes. Resulting print must be completely black. | | |

TABLE 5-2 (CONT)
Performance Check Summary

| Characteristics | Performance Requirements | Part I Performance Check Procedure Title | Part II Adjustment and Performance Check Procedure Title |
|---------------------------------------|---|--|---|
| REMOTE CONNECTORS AND SWITCHES | | | |
| CONTROL ILLUMINATION | High, medium, and off. Three-position switch located on rear panel of power supply. | Checked in Operators Checkout Procedure in Section 2. | |
| CAMERA POWER | Three-contact connector compatible with Tektronix C-50 series cameras. | Does not normally require customer verification. Satisfactory operation is substantiated at the factory. | |
| Bottom Pin | Ground. | | |
| Center Pin | Single sweep reset. | | |
| Top Pin | +15 V. | | |
| SINGLE SWEEP RESET | Bnc input connector on rear panel to reset single-sweep function of time-base units installed in A and B HORIZ compartments. | | |
| Signal Required | Closure to ground or switching from the high level (+50 to +10 V; sink less than 40 μ A) to the low level (+0.5 V to -5 V; sink less than 12 mA), in less than 1 ms, resets the sweep. Compatible to 15 V open collector TTL source. | | |
| A SINGLE SWEEP READY | Bnc connector on rear panel. Remote ready indicator for A HORIZ time-base unit. | | |
| Output Signal | Open when not ready. +5 V at 47 Ω source impedance when ready. Output will light a No. 49 bulb. | | |
| B SINGLE SWEEP READY | Bnc connector on rear panel. Remote ready indicator for B HORIZ time-base unit. | | |
| Output Signal | Open when not ready. +5 V at 47 Ω source impedance when ready. Output will light a No. 49 bulb. | | |
| GRATICULE/READOUT SINGLE SHOT | Bnc connector on rear panel. Switching to the low level (+1 V to -5 V; sink less than 2 mA) from the high level (+10 V to +15 V; sink less than 0.3 mA), in less | | |

TABLE 5-2 (CONT)
Performance Check Summary

| Characteristics | Performance Requirements | Part I Performance Check Procedure Title | Part II Adjustment and Performance Check Procedure Title |
|-----------------|--------------------------|--|---|
|-----------------|--------------------------|--|---|

REMOTE CONNECTORS AND SWITCHES (CONT)

| | | | |
|---|---|--|--|
| GRATICULE/READOUT SINGLE SHOT (cont) | than 1 μ s, triggers the Readout to display one complete readout frame and illuminates the graticule for approximately 0.5 s. Compatible to 15 V open collector TTL source. | Does not normally require customer verification. Satisfactory operation is substantiated at the factory. | |
| Probe Power | Two probe power connectors on rear panel. | | |
| Pin 1 | +5 V dc. | | |
| Pin 2 | Chassis ground. | | |
| Pin 3 | -15 V dc. | | |
| Pin 4 | +15 V dc. | | |
| Z-AXIS INPUT (External) | Bnc connector on rear panel. | | |
| Polarity and Sensitivity | Positive 2 V provides complete blanking from maximum intensity condition. Negative 2 V provides complete unblanking from minimum intensity condition. | | |
| Low Frequency Limit | Dc. | | |
| Input Resistance | Approximately 470 Ω . | | |
| Input Capacitance | Less than 50 pF. | | |
| Open Circuit Voltage | Approximately 0 V. | | |
| Maximum Input Voltage | 15 V (dc plus peak ac). | | |
| Maximum Repetition Rate | 1 MHz. | | |
| LINE VOLTAGE SELECTOR | Selects 115 V or 230 V range. | | |

POWER SOURCE

| | | | |
|-------------------------|--|--|--|
| VOLTAGE RANGE (AC, RMS) | Selected by rear-panel LINE VOLTAGE SELECTOR switch. | Does not normally require customer verification. Satisfactory operation is substantiated at the factory. | |
| 115 V Rated | From 90 V to 132 V. | | |
| 230 V Rated | From 180 V to 250 V. | | |
| Line Frequency | From 48 Hz to 440 Hz. | | |
| Power Consumption | 210 W, nominal. | | |

TABLE 5-2 (CONT)
Performance Check Summary

| Characteristics | Performance Requirements | Part I Performance Check Procedure Title | Part II Adjustment and Performance Check Procedure Title |
|----------------------------|---|---|---|
| POWER SOURCE (CONT) | | | |
| Maximum Current | 3.5 A at 60 Hz, 90 V Line. 1.8 A at 60 Hz, 180 V Line. | Does not normally require customer verification. Satisfactory operation is substantiated at the factory. | |
| Fuse | 4 A Fast Blow. | | |

ADJUSTMENT INTERVAL

To maintain instrument accuracy, check performance every 2000 hours of operation, or annually if used infrequently. Before complete adjustment, thoroughly clean and inspect this instrument as outlined in the Maintenance section.

TEKTRONIX FIELD SERVICE

Tektronix Field Service Centers and the Factory Service Center provide instrument repair and adjustment services. Contact your Tektronix Field Office or representative for further information.

TEST EQUIPMENT REQUIRED

The test equipment listed in Table 5-3 is required for a complete Adjustment and Performance Check of the instrument. If only a Performance Check is to be performed, the items required for Adjustment are not required and are so indicated by footnote 1. The remaining test equipment is common to both procedures.

The specifications for test equipment, given in Table 5-3, are the minimum required to meet the performance requirements. Detailed operating instructions for test equipment are omitted in these procedures. Refer to the test equipment instruction manual if more information is needed.

SPECIAL FIXTURES

Special fixtures are used only where they facilitate instrument adjustment. These fixtures are available from Tektronix, Inc. Order by part number from Tektronix Field Offices or representatives.

TEST EQUIPMENT ALTERNATIVES

All of the listed test equipment is required to completely check and adjust this instrument. However, complete checking or adjusting may not always be necessary or desirable. You may be satisfied with checking only selected characteristics, thereby reducing the amount of test equipment actually required.

The checks and adjustment procedures in Part II are based on the first item of equipment given as an example. When other equipment is substituted, control settings or setups may need to be altered. If the exact item of equipment given as an example in Table 5-3 is not available, first check the Minimum Specifications column carefully to see if any other equipment might suffice. Then check the Purpose column to see where this item is used. If used for a performance check or adjustment that is of little or no importance for your measurement requirements, the item and corresponding step(s) can be deleted.

TABLE 5-3
Test Equipment

| Description | Minimum Specifications | Purpose | Examples of Applicable Test Equipment |
|--|---|---|--|
| 1. Test Oscilloscope (with 10X probes) | Bandwidth, dc to 100 MHz; deflection factor, 50 mV to 10 V/division at probe tip; inputs, two 1 M Ω ; capable of inverting one input for operation as differential amplifier; sweep rates, 1 ms to 0.1 μ s/division. | Used throughout Checks and Adjustment procedures. | a. TEKTRONIX 7603 Oscilloscope with 7A26 Dual Trace Amplifier, 7B80 Time Base, and P6063B Switchable Attenuation Probes. b. TEKTRONIX 2445 150 MHz Oscilloscope with P6131 Probe. c. Refer to Tektronix Products catalog for compatible equipment. |

**TABLE 5-3 (CONT)
Test Equipment**

| Description | Minimum Specifications | Purpose | Examples of Applicable Test Equipment |
|--|--|---|---|
| 2. Amplifier, Dual-Channel | Tektronix 7A-series dual-channel amplifier with 1 M Ω input impedance. | Used to check and adjust readout system. | a. Any Tektronix dual-channel amplifier (may use the one from the test oscilloscope). |
| 3. Amplifier | Tektronix 7A-series amplifier. | Used throughout procedure to provide vertical input to the 7904A under adjustment. | a. TEKTRONIX 7A29 Amplifier. b. TEKTRONIX 7A19 Amplifier. |
| 4. Time Base (two needed) | Tektronix 7B-series time base. | Used throughout procedure to provide sweep for the 7904A. | a. TEKTRONIX 7B15 Delaying Time Base and 7B10 Time Base. b. TEKTRONIX 7B85 Delaying Time Base and 7B80 Time Base. |
| 5. Precision DC Voltmeter (DVM), with test leads | Range, 0 to 200 V; accuracy, within 0.1%. | Check and adjust power supply voltages. | a. TEKTRONIX DM 501A Digital Multimeter with TM 500-series Power Module. b. Fluke Model 825A Differential DC Voltmeter. c. TEKTRONIX 7D13A Digital Multimeter and 7000-series test oscilloscope may be used if lower performance is acceptable. |
| 6. Low-Frequency Sine-Wave Generator | Frequency, 50 kHz; amplitude, 2 V. | Check External Z-Axis Operation. Check/Adjust X-Y Delay Compensation. | a. TEKTRONIX FG 503 Function Generator with TM 500-series Power Module. b. General Radio 1310-B Oscillator. |
| 7. Medium-Frequency Sine-Wave Generator | Frequency, 100 MHz; output amplitude, variable from 0.5 to 4 volts into 50 Ω . | Check Vertical Channel Isolation. | a. TEKTRONIX SG 503 Leveled Sine Wave Generator, and TM 500-series Power Module. |
| 8. High-Frequency Sine-Wave Generator | Frequency, 250 kHz to 1 GHz; reference frequency, 20 MHz or lower; output amplitude, variable from 0.5 to 4 volts into 50 Ω . | Check bandwidth and vertical channel isolation. | a. TEKTRONIX SG 504 Leveled Sine Wave Generator with SG 504 Output Head. b. Wiltron Model 610C Swept Frequency Generator with Model 61083C, 10 to 1220 MHz plug-in unit. |
| 9. Plug-In Extender ¹ | For 7000-series plug-in unit. | Provides access to supply voltages without removing the 7904A power supply. | Rigid Calibration Fixture, Tektronix Part 067-0589-00. |
| 10. Signal Standardizer (two needed) | Produces gain-check and pulse-response waveforms. | Used throughout procedure to standardize 7904A so that plug-in units can be interchanged without complete readjustment. | a. Tektronix Calibration Fixture 067-0587-02. b. Tektronix Calibration Fixture 067-0587-01. c. Tektronix 7000-series plug-in units with suitable signal sources may be substituted if lower performance is acceptable. |

¹Used for Adjustment only; not used for Performance Check.

TABLE 5-3 (CONT)
Test Equipment

| Description | Minimum Specifications | Purpose | Examples of Applicable Test Equipment |
|---|---|--|---|
| 11. Time-Mark Generator | Marker frequency, 0.1 s to 1 ns; amplitude, 0.5 V into 50 Ω ; stability, within one part in 10^5 . | Check/Adjust Calibrator 1 kHz Repetition Rate, Check and Adjust Horizontal Timing. | a. TEKTRONIX TG 501 Time Mark Generator and TM 500-series Power Module. |
| 12. Coaxial Cable | Length, 18 inches; impedance, 50 Ω ; connectors, bnc male. | Connect various signals. | a. Tektronix Part 012-0076-00. |
| 13. Coaxial Cable (four needed) | Length, 42 inches; impedance, 50 Ω ; connectors, bnc male. | Connect various signals. | a. Tektronix Part 012-0057-01. |
| 14. Attenuator | Attenuation, 2X; impedance, 50 Ω ; accuracy, $\pm 2\%$; connectors: bnc male, 1; bnc female, 1. | Reduce amplitude of SG 504 output. | a. Tektronix Part 011-0069-02. |
| 15. Adapter, BNC T | Connectors: bnc male, 1; bnc female, 2; impedance, 50 Ω . | Connect one signal to two places. | a. Tektronix Part 103-0030-00. |
| 16. Screwdriver, Phillips ¹ | Length of shaft, 3 inches; tip, #2. | Used to remove power supply and rear panel. | a. Tektronix Part 003-0684-00. |
| 17. Screwdriver, Slotted ¹ | Length of shaft, 3 inches; width of shaft, 3/32 inches. | Adjust various controls. | a. Tektronix Part 003-0192-00. |
| 18. Tool, Alignment, Nylon ¹ | Adjustment end, 5/64-inch male hexagon on three-inch shaft. | Adjust 2-5 ns compensation. | Consists of: Handle, Tektronix Part 003-0307-00, and bit, Tektronix Part 003-0310-00. |
| 19. Tool, Alignment ¹ | Length of shaft, 1 inch. | Adjust various controls. | a. Tektronix Part 003-0000-00. |
| 20. Time-base unit | TEKTRONIX dual time-base with Aux Z-axis output. | Used to check Aux Z-axis circuitry. | TEKTRONIX 7B53A or 7B92A Time-Base. |

¹Used for Adjustment only; not used for Performance Check.

PART I—PERFORMANCE CHECK

The following procedure (Part I—Performance Check) verifies electrical specifications without removing instrument covers or making internal adjustments. All tolerances given are as specified in the Specification tables (section 1) in this manual.

Part II—Adjustment and Performance Check provides the information necessary to: (1) verify that the instrument meets the electrical specifications, (2) verify that all controls function properly, and (3) perform all internal adjustments.

A separate Operators Checkout Procedure is provided in section 2 for familiarization with the instrument and to verify that all controls, indicators and connectors function properly.

See Table 5-1, Checks and Adjustments Procedure Electives, at the beginning of this section, for information on performing a Partial Part I—Performance Check procedure.

INDEX TO PERFORMANCE CHECK PROCEDURE

- A. Z-AXIS AND DISPLAY
 - 1. Z-Axis and Display Preliminary Setup 5-15
 - 2. Check Geometry 5-15
- B. CALIBRATOR AND OUTPUT SIGNALS
 - 1. Calibrator and Output Signals Preliminary Setup 5-16
 - 2. Check Calibrator Output Voltage 5-16
 - 3. Check Calibrator 1 kHz Repetition Rate 5-17
 - 4. Check Calibrator Rise Time, Fall Time, and Duty Cycle 5-18
 - 5. Check A and B Sawtooth Output Signals 5-19
 - 6. Check A and B Gate Output Signals 5-19
 - 7. Check Graticule Illumination Operation 5-20
- C. TRIGGER SYSTEM
 - 1. Trigger System Preliminary Setup 5-21
 - 2. Check Vertical Signal Out DC Centering 5-21
 - 3. Check Trigger Selector Operation 5-22
- D. HORIZONTAL SYSTEM
 - 1. Horizontal System Preliminary Setup 5-23
 - 2. Check Horizontal Gain and Low Frequency Linearity 5-23
 - 3. Check High-Frequency Timing 5-24
 - 4. Check X-Y Delay Compensation 5-24
- E. VERTICAL SYSTEM
 - 1. Vertical System Preliminary Setup 5-26
 - 2. Check Vertical Amplifier Gain 5-26
 - 3. Check Vertical Low-Frequency Linearity 5-27

- 4. Check Vertical Amplifier 500 MHz Gain 5-27
- 5. Check Vertical Channel Isolation 5-28
- 6. Check Vertical Display Modes 5-29
- 7. Check Vertical Trace Separation (B) Operation 5-30

- F. READOUT SYSTEM
 - 1. Readout System Preliminary Setup 5-31
 - 2. Check Readout Modes 5-31

PERFORMANCE CHECK POWER-UP SEQUENCE

The performance of this instrument can be checked at any ambient temperature from 0° to +50° C unless otherwise stated.

1. Check that the 7904A has been set for the proper power source and also that a suitable power cord and plug has been attached. Refer to Power Source Information in Section 1—General Information for specific details.
2. Connect the 7904A to a suitable power source.
3. Press the POWER button and allow at least 20 minutes warmup before proceeding.



To prevent instrument damage, turn off 7904A POWER before installing or removing plug-in units.

A. Z-AXIS AND DISPLAY

Equipment Required: (Numbers correspond to those listed in Table 5-3, Test Equipment.)

- | | |
|--------------------------------------|--|
| 3. Amplifier | 13. Coaxial Cable (two 42-inch required) |
| 4. Time-Base | 15. Adapter, bnc T |
| 6. Low-Frequency Sine-Wave Generator | |

A1. Z-AXIS AND DISPLAY PRELIMINARY SETUP

- Perform the Performance Check Power-Up Sequence.
- Refer to Section 6, Instrument Options, and to the Change Information at the rear of this manual for any modifications which may affect this procedure.
- Set the 7904A controls as follows:

POWER.....On (pushbutton in)
 VERTICAL MODE.....LEFT
 VERT TRACE SEPARATION (B)..... Midrange
 A TRIGGER SOURCE..... VERT MODE
 A INTENSITY..... Fully counterclockwise
 HORIZONTAL MODE..... A
 B INTENSITY..... Fully counterclockwise
 B TRIGGER SOURCE..... VERT MODE
 FOCUS..... Midrange
 READOUT..... OFF (in detent)
 GRAT ILLUM..... Midrange
 CONTROL ILLUMINATION..... MEDIUM
 (rear panel)

A2. CHECK GEOMETRY

NOTE

First perform step A1, then proceed.

A2. SETUP CONDITIONS

7904A Controls:
 VERTICAL MODE.....ALT
 HORIZONTAL MODE..... CHOP
 A and B INTENSITY..... Midrange

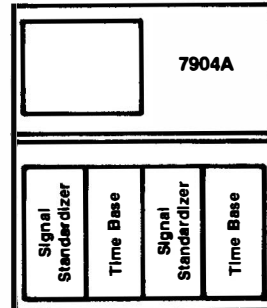

Test Equipment Controls:
 LEFT VERT and A HORIZ Signal Standardizers
 Test..... Vert or Horiz Gain
 Rep Rate..... 100 kHz
 RIGHT and B Time Bases
 Sweep Rate..... 2 μ s/div
 Triggering..... Auto, AC, External
 4593-410

- Set both signal standardizer Position controls to superimpose the crosshatch display over the vertical and horizontal graticule center lines (the intensified vertical and horizontal traces should be aligned with the vertical and horizontal graticule center lines).
- Set the front-panel FOCUS and INTENSITY controls for a well-defined display.

NOTE

The front-panel TRACE ROTATION adjustment may need to be set for optimum trace-to-graticule alignment.

- CHECK**—that the vertical and horizontal traces which cross at graticule center are aligned with the graticule vertical and horizontal center lines, within 0.1 division.
- CHECK**—the horizontal traces at the top and bottom of the graticule for 0.1 division or less of bowing or tilt.

B. CALIBRATOR AND OUTPUT SIGNALS

Equipment Required: (Numbers correspond to those listed in Table 5-3, Test Equipment.)

- | | |
|---------------------------------|--|
| 1. Test Oscilloscope | 11. Time-Mark Generator |
| 4. Time-Base | 13. Coaxial Cables (four 42-inch required) |
| 5. Precision DC Voltmeter (DVM) | 15. Adapter, bnc T |

B1. CALIBRATOR AND OUTPUT SIGNALS PRELIMINARY SETUP

- Perform the Performance Check Power-Up Sequence.
- Refer to Section 6, Instrument Options, and the Change Information at the rear of this manual for any modifications which may affect this procedure.
- Set the 7904A controls as follows:

POWER switch On
 VERTICAL MODE RIGHT
 VERT TRACE SEPARATION (B) Midrange
 A TRIGGER SOURCE VERT MODE
 A INTENSITY Fully counterclockwise
 HORIZONTAL MODE A
 B INTENSITY Fully counterclockwise
 B TRIGGER SOURCE VERT MODE
 READOUT INTENSITY OFF (in detent)
 GRAT ILLUM Midrange
 BEAMFINDER Pushbutton out
 CALIBRATOR 4 V pushbutton in

B2. CHECK CALIBRATOR OUTPUT VOLTAGE

NOTE

First perform step B1, then proceed.

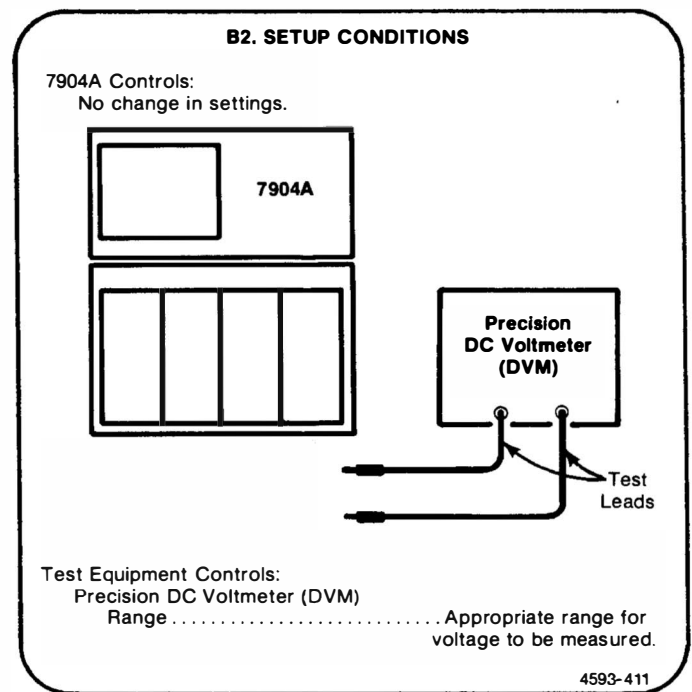

- Set the 4 V and 0.4 V CALIBRATOR pushbuttons to the pressed-in position.
- Connect the precision dc voltmeter (DVM) to the CALIBRATOR output connector.
- CHECK**—for a DVM reading of 0.4008 volt, within the limits of 0.4004 to 0.4012 volt.

**B3. CHECK CALIBRATOR 1 kHz
REPETITION RATE**

NOTE

If the preceding step was not performed, first perform step B1, then proceed.

NOTE

A frequency counter with an accuracy of at least 0.1% may be used to check the CALIBRATOR repetition rate.

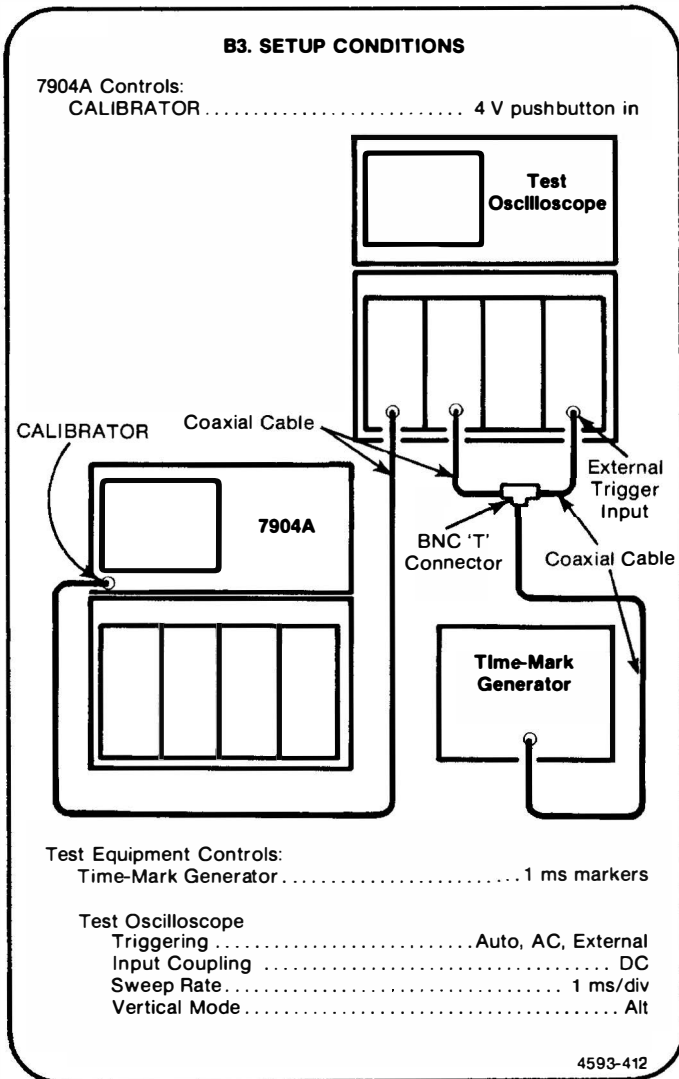

- a. Connect 1-millisecond time-markers to the test oscilloscope external trigger input and to the noninverting vertical channel of the test oscilloscope (use a bnc T connector). Connect the 7904A CALIBRATOR output to the inverting input of the test oscilloscope.
- b. Set the test oscilloscope Triggering Level control for a stable time-mark display.
- c. Set the test oscilloscope vertical deflection factors to display 2 divisions of CALIBRATOR signal and 1 division of time-marker signal.
- d. Set the test oscilloscope Vertical Mode to Add.
- e. Set the test oscilloscope sweep rate to 0.2 second/division.
- f. **CHECK**—that the time required for the 1-millisecond time marks to drift from the positive level of the CALIBRATOR signal to the negative level and back to the positive level, is more than 0.4 second (2 divisions). This time can be measured directly from the display by observing the number of divisions that the markers move across the display area before it returns to the positive level.

Checks and Adjustment—7904A
Part I—Performance Check

B4. CHECK CALIBRATOR RISE TIME, FALL TIME, AND DUTY CYCLE

NOTE

If the preceding step was not performed, first perform step B1, then proceed.

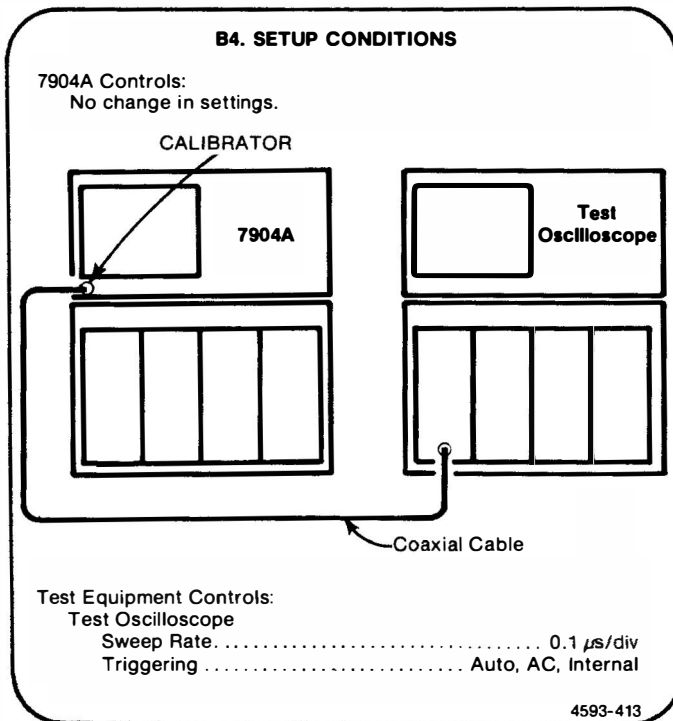

- a. Connect the CALIBRATOR output to the inverting vertical input of the test oscilloscope.
- b. Set the test oscilloscope vertical deflection to display 4 divisions of CALIBRATOR signal.
- c. Set the test oscilloscope for a stable display, triggered on the positive transition of the CALIBRATOR signal.
- d. **CHECK**—the displayed waveform for not more than 5 divisions horizontally between the 10% to 90% points of the waveform (rise time, 0.5 microsecond or less).
- e. Set the test oscilloscope for a stable display triggered on the negative transition of the waveform.
- f. **CHECK**—the displayed waveform for not more than 5 divisions between the 90% and 10% amplitude points (fall time, 0.5 microsecond or less).
- g. Set the test oscilloscope triggering for positive slope and auto mode with ac coupling from the internal source at a sweep rate of 0.1 millisecond/division. Set the triggering controls so that the display starts at the 50% point on the rising edge of the waveform.
- h. Set the test oscilloscope sweep magnifier to X10. Then, position the display horizontally so the falling edge of the waveform aligns with the center vertical graticule line.
- i. Set the test oscilloscope vertical to invert the display.
- j. **CHECK**—that the 50% point on the falling edge of the waveform now displayed is within 0.2 divisions horizontally of the center line. (Indicates duty cycle of 50% within 0.2%.)

NOTE

The display is triggered on the opposite slope, even though the display appears the same.

B5. CHECK A AND B SAWTOOTH OUTPUT SIGNALS

NOTE

If the preceding step was not performed, first perform step B1, then proceed.

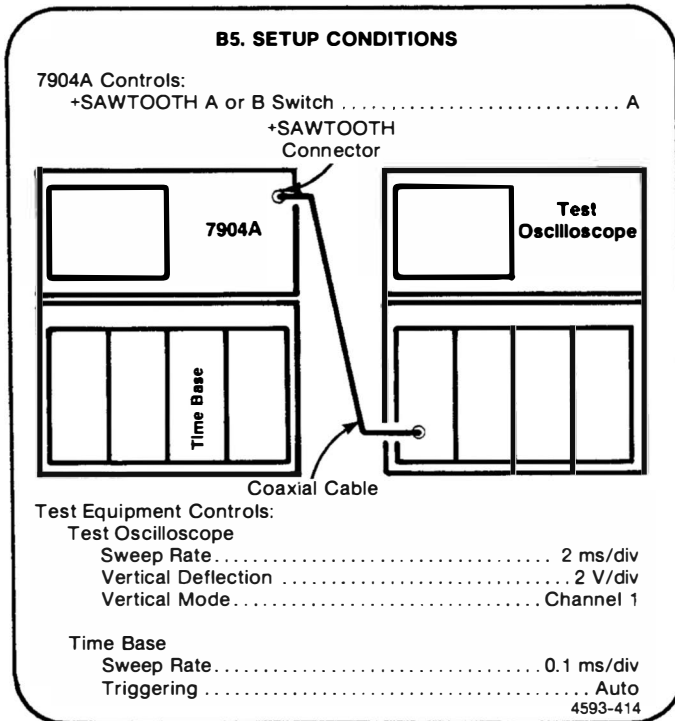

- Connect the +SAWTOOTH output connector to the test oscilloscope channel 1 vertical input (one-megohm input).
- CHECK**—that the slope of the test oscilloscope display rises 2 volts/horizontal division, within 10% (10-volt sawtooth for 5 division sweep on test oscilloscope screen) and that the sawtooth baseline is within one volt of ground.
- Move the time base to the 7904A B HORIZ compartment.
- Set the +SAWTOOTH selector switch to the B position.
- CHECK**—the test oscilloscope display for 2 volts/division of sweep within 10% (10-volt sawtooth for 5 division sweep on the 7904A crt screen) and that the sawtooth baseline is within one volt of ground.

B6. CHECK A AND B GATE OUTPUT SIGNALS

NOTE

If the preceding step was not performed, first perform step B1, then proceed.

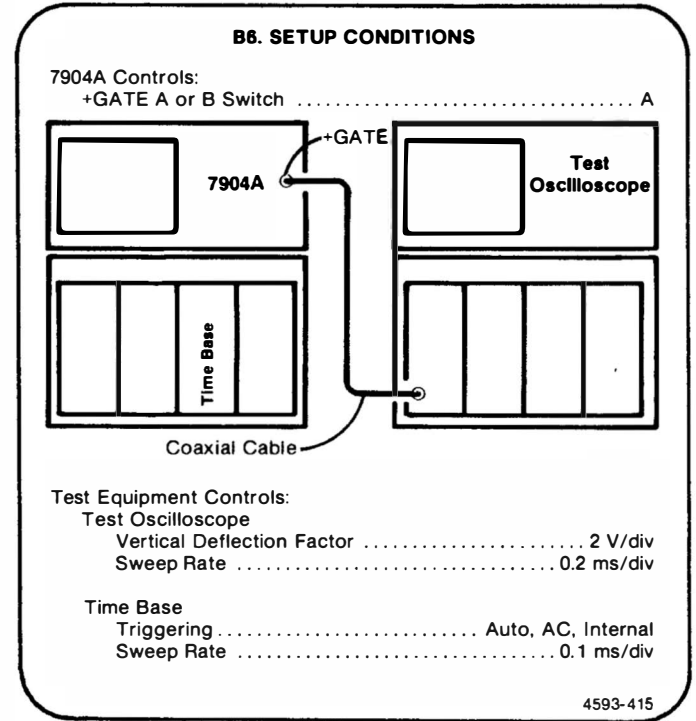

- CHECK**—the test oscilloscope display for a gate waveform 5 divisions in amplitude, within 10%, and a baseline at zero volts, within one volt.
- Move the time-base unit to the B HORIZ compartment.
- Set the +GATE selector switch to the B position.
- CHECK**—the test oscilloscope display for a gate waveform 5 divisions in amplitude, within 10%, and a baseline at zero volts, within one volt.

Checks and Adjustment—7904A
Part I—Performance Check

B7. CHECK GRATICULE ILLUMINATION OPERATION

NOTE

If the preceding step was not performed, first perform step B1, then proceed.

B7. SETUP CONDITIONS

7904A Controls:
 GRAT ILLUM + GATE or EXT Switch+GATE
 +GATE A or B Switch A
 HORIZONTAL MODE A

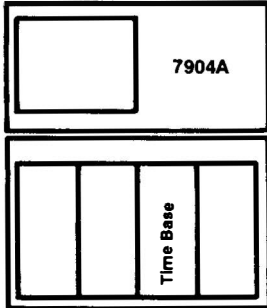

Test Equipment Controls:
 Time Base
 Sweep Rate0.2 s/div
 Triggering Auto. AC, Internal

4593-416

- a. **CHECK**—that rotating the GRAT ILLUM control throughout its range varies the illumination of the graticule.
- b. Set the GRAT ILLUM control fully clockwise to the PULSED detent position.
- c. Set the A INTENSITY control for a visible display.
- d. **CHECK**—that graticule illumination occurs only after the time-base has completed a sweep (adjust GRAT ILLUM PRESET, if necessary).
- e. Set the GRAT ILLUM +GATE or EXT switch to EXT.
- f. **CHECK**—that pressing the GRAT ILLUM MAN pushbutton causes one momentary illumination of the graticule.
- g. Set the GRAT ILLUM control to midrange (out of the PULSED detent position).

C. TRIGGER SYSTEM

Equipment Required: (Numbers correspond to those listed in Table 5-3, Test Equipment.)

- | | |
|-----------------------------|-------------------------|
| 1. Test Oscilloscope | 10. Signal Standardizer |
| 2. or 3. Amplifier | 13. Coaxial Cable |
| 4. Time-Base (two required) | |

C1. TRIGGER SYSTEM PRELIMINARY SETUP

- Perform the Performance Check Power-Up Sequence.
- Refer to Section 6, Instrument Options, and the Change Information at the rear of this manual for any modifications which may affect this procedure.
- Set the 7904A controls as follows:

POWER switch On
 VERTICAL MODE RIGHT
 VERT TRACE SEPARATION (B) Midrange
 A TRIGGER SOURCE VERT MODE
 A INTENSITY Fully counterclockwise
 HORIZONTAL MODE A
 B INTENSITY Fully counterclockwise
 B TRIGGER SOURCE VERT MODE
 FOCUS Midrange
 READOUT INTENSITY OFF (in detent)
 GRAT ILLUM Midrange
 BEAMFINDER Pushbutton out

C2. CHECK VERTICAL SIGNAL OUT DC CENTERING

NOTE

First perform step C1, then proceed.

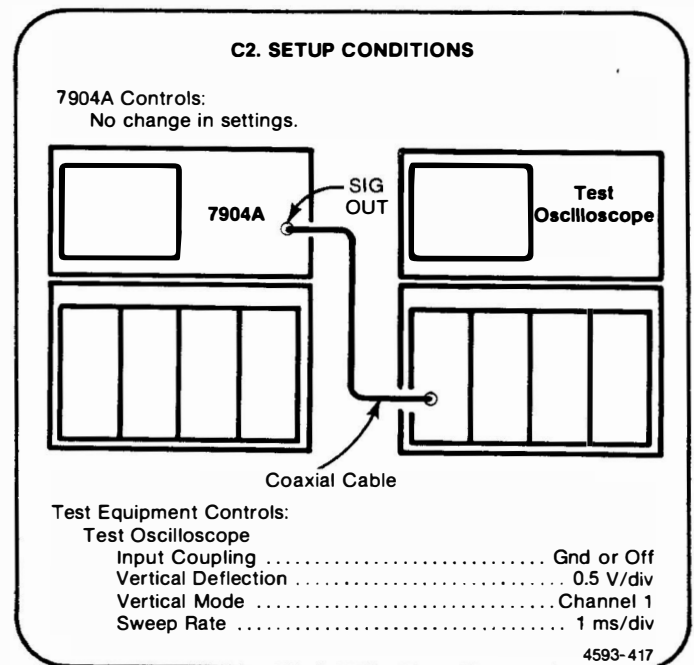

- Establish a ground reference for the test oscilloscope by positioning the trace to the graticule center line. Do not change the test oscilloscope Position control after setting this ground reference.
- Set the test oscilloscope input coupling switch to dc.
- CHECK**—that the dc level of the test oscilloscope display is within 1 division of the ground reference established in part a.

C3. CHECK TRIGGER SELECTOR OPERATION

NOTE

If the preceding step was not performed, first perform step C1, then proceed.

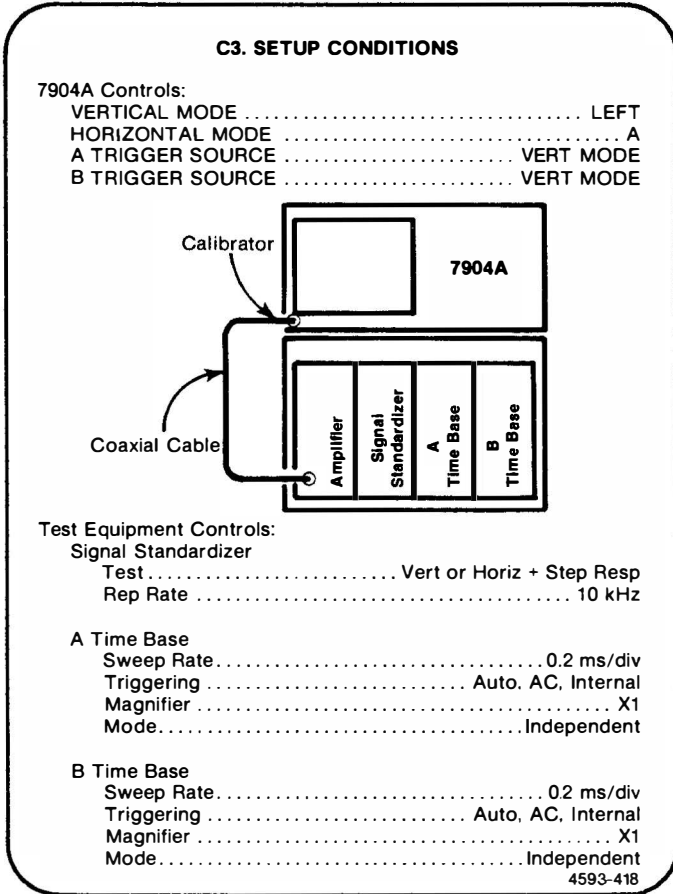

- a. Set the A INTENSITY control for a visible display. Set the amplifier for a 2-division display in the upper half of the graticule area. Use the A time-base Triggering Level control to trigger the display.
- b. Set the VERTICAL MODE switch to RIGHT.
- c. Set the signal standardizer Amplitude and Position controls for a 2 division display in the lower half of the graticule area.
- d. Set the VERTICAL MODE switch to ALT.
- e. **CHECK**—the crt display for 1 kHz and 10 kHz triggered waveforms (adjust the time-base Triggering Level controls as necessary).
- f. Set the VERTICAL MODE switch to ADD.
- g. **CHECK**—the crt display for a triggered waveform.
- h. Set the VERTICAL MODE switch to CHOP.
- i. **CHECK**—the crt for a stable display of the 1 kHz waveform only.
- j. Set the A TRIGGER SOURCE switch to LEFT VERT.
- k. **CHECK**—sequentially select all positions of the VERTICAL MODE switch and check for a stable display of only the 1 kHz waveform.
- l. Set the A TRIGGER SOURCE switch to RIGHT VERT.
- m. **CHECK**—sequentially select all positions of the VERTICAL MODE switch and check for a stable display of only the 10 kHz waveform.
- n. Set the VERTICAL MODE switch to ALT, the HORIZONTAL MODE switch to B, and the B INTENSITY control for a visible display.
- o. **CHECK**—the crt display for 1 kHz and 10 kHz triggered waveforms.
- p. Set the VERTICAL MODE switch to ADD.
- q. **CHECK**—crt for a stable display.
- r. Set the VERTICAL MODE switch to CHOP.
- s. **CHECK**—crt for a stable display of only the 1 kHz waveform.
- t. Set the B TRIGGER SOURCE switch to LEFT VERT.
- u. **CHECK**—sequentially select all positions of the VERTICAL MODE switch and check for a stable display of only the 1 kHz waveform.
- v. Set the B TRIGGER SOURCE switch to RIGHT VERT.
- w. **CHECK**—sequentially select all positions of the VERTICAL MODE switch and check for a stable display of only the 10 kHz waveform.
- x. Set the VERTICAL MODE switch to ALT, the HORIZONTAL MODE switch to ALT, and the A and B TRIGGER SOURCE switches to VERT MODE.
- y. **CHECK**—that the B HORIZ time-base is triggered on the 1 kHz waveform and the A HORIZ time-base is triggered on the 10 kHz waveform (set the time base Triggering Level controls for triggered sweeps).

D. HORIZONTAL SYSTEM

Equipment Required: (Numbers correspond to those listed in Table 5-3, Test Equipment.)

- | | |
|--------------------------------------|-----------------------------|
| 2, 3. Amplifier (two required) | 11. Time-Mark Generator |
| 4. Time Base | 12. Coaxial Cable (18-inch) |
| 6. Low-Frequency Sine-Wave Generator | 13. Coaxial Cable (42-inch) |
| 10. Signal Standardizer | 15. Adapter, BNC T |

D1. HORIZONTAL SYSTEM PRELIMINARY SETUP

- Perform the Performance Check Power-Up Sequence.
- Refer to Section 6, Instrument Options, and the Change Information at the rear of this manual for any modifications which may affect this procedure.
- Set the 7904A controls as follows:

POWER switch On
 VERTICAL MODE RIGHT
 VERT TRACE SEPARATION (B) Midrange
 A TRIGGER SOURCE VERT MODE
 A INTENSITY Midrange
 HORIZONTAL MODE A
 B INTENSITY Midrange
 B TRIGGER SOURCE VERT MODE
 READOUT INTENSITY OFF (in detent)
 GRAT ILLUM As desired
 CONTROL ILLUM MEDIUM (rear panel)
 CALIBRATOR 0.4 V

D2. CHECK HORIZONTAL GAIN AND LOW FREQUENCY LINEARITY

NOTE

First perform step D1, then proceed.

D2. SETUP CONDITIONS

7904A Controls:
 HORIZONTAL MODE B

The diagram shows a rectangular control panel labeled '7904A'. At the top right, there is a switch labeled 'HORIZONTAL MODE' with a dotted line pointing to the letter 'B'. Below this, the panel is divided into two main sections. The upper section contains a single large rectangular control. The lower section is divided into two vertical columns. The left column is labeled 'Time Base' and the right column is labeled 'Signal Standardizer'.

Test Equipment Controls:
 Time Base
 Triggering Auto, AC, External
 Sweep Rate 5 μ s/div

Signal Standardizer
 Test Vert or Horiz Gain
 Rep Rate 100 kHz

4593-419

- Align the bright vertical trace on the center vertical graticule line using the signal standardizer Position control.
- CHECK**—that the second and tenth vertical traces align with the second and tenth graticule lines, within 0.08 division.
- CHECK**—along the horizontal graticule line for 0.05 division or less error at each vertical graticule line intersection.
- Move the signal standardizer to the A HORIZ compartment and change the HORIZONTAL MODE switch to A.
- CHECK**—that the deflection between the second and tenth graticule lines is the same as in part c of this step, within 0.08 division.

Checks and Adjustment—7904A
Part I—Performance Check

D3. CHECK HIGH-FREQUENCY TIMING

NOTE

If the preceding step was not performed, first perform step D1, then proceed.

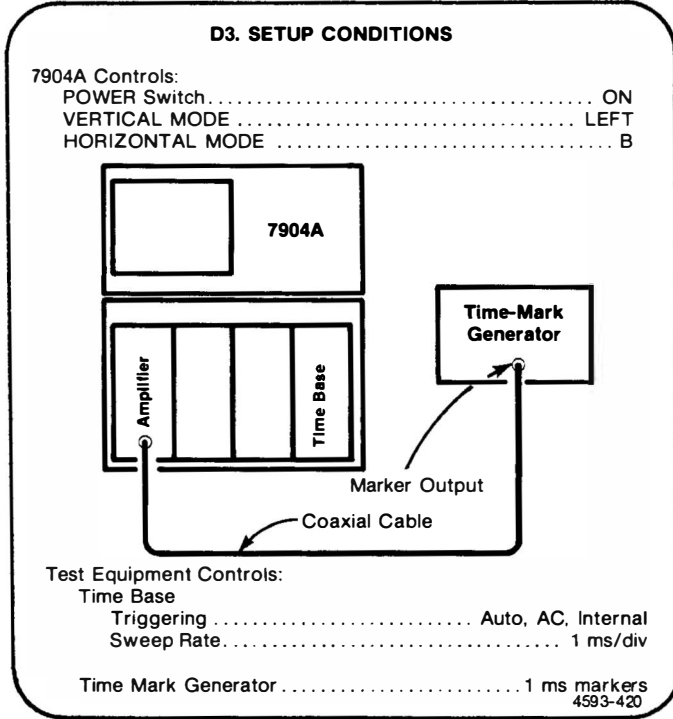

- a. Set the amplifier deflection factor for approximately two divisions of display (set the time-base Triggering Level as necessary for a stable display).
- b. Examine the crt display for one time-marker per division over the center eight divisions.
- c. Set the time-base unit front-panel Swp Cal adjustment for one time-marker per division over the center eight divisions.
- d. **CHECK**—refer to the Performance Check procedures in the time-base unit instruction/service manual to check high-frequency timing and accuracy to 0.5 ns (500 ps is the fastest calibrated sweep rate for the 7904A).

D4. CHECK X-Y DELAY COMPENSATION

NOTE

If the preceding step was not performed, first perform step D1, then proceed.

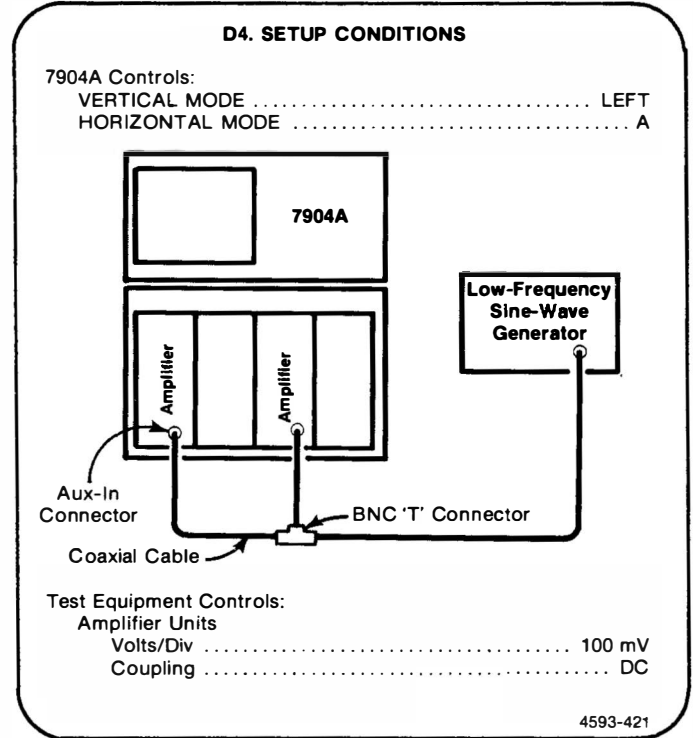

- a. Set the low-frequency sine-wave generator for eight divisions of vertical and horizontal deflection at 35 kHz. Set the Amplifier unit controls to match the vertical and horizontal deflection.
- b. **CHECK**—crt display for a Lissajous display with separation of 0.28 division or less (indicates 2° or less phase shift; see Figure 5-1).
- c. Remove the amplifier unit from the A HORIZ compartment and install it in the B HORIZ compartment (leave signal connected). Set the HORIZONTAL MODE to B.
- d. Repeat part b of this step.

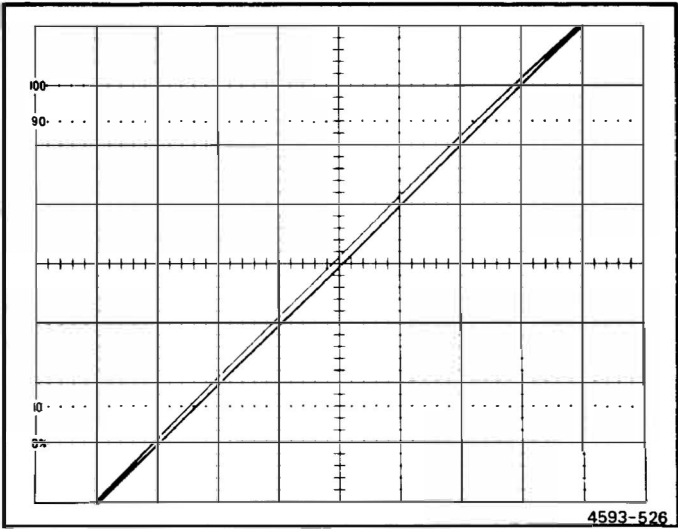

Figure 5-1. Typical display when checking X-Y phase compensation.

E. VERTICAL SYSTEM

Equipment Required: (Numbers correspond to those listed in Table 5-3, Test Equipment.)

- | | |
|---|-------------------------|
| 3. Amplifier | 10. Signal Standardizer |
| 4. Time Base (two required) | 13. Coaxial Cable |
| 7. Medium-Frequency Sine-Wave Generator | 14. Attenuator (2X) |
| 8. High-Frequency Sine-Wave Generator | |

E1. VERTICAL SYSTEM PRELIMINARY SETUP

- Perform the Performance Check Power-Up Sequence.
- Refer to Section 6, Instrument Options, and the Change Information at the rear of this manual for any modifications which may affect this procedure.
- Set the 7904A controls as follows:

POWER switch On
 VERTICAL MODE RIGHT
 VERT TRACE SEPARATION (B) Midrange
 A TRIGGER SOURCE VERT MODE
 A INTENSITY Midrange
 HORIZONTAL MODE A
 B INTENSITY Midrange
 B TRIGGER SOURCE VERT MODE
 FOCUS Midrange
 READOUT OFF (in detent)
 GRAT ILLUM As desired
 BEAMFINDER Pushbutton out

E2. CHECK VERTICAL AMPLIFIER GAIN

NOTE

First perform step E1, then proceed.

E2. SETUP CONDITIONS

7904A Controls:
No change in settings.

The diagram shows a rectangular control panel labeled '7904A'. It is divided into two main horizontal sections. The top section is labeled 'Signal Standardizer' and contains a vertical scale with a central bright trace. The bottom section is labeled 'Time Base' and contains a vertical scale with a central bright trace. The labels 'Signal Standardizer' and 'Time Base' are written vertically within their respective sections.

Test Equipment Controls:

Time Base
 Sweep Rate 1 ms/div
 Triggering Auto, AC, External

Signal Standardizer
 Test Vert or Horiz Gain
 Rep Rate 100 kHz
 4593-422

- Position the signal standardizer display to align the bright center trace with the graticule center line.
- CHECK**—for one trace per graticule division within 0.05 division over the center six graticule divisions. Note the exact error for comparison in part f.
- Remove the signal standardizer from the RIGHT VERT compartment and install it in the LEFT VERT compartment.
- Set the VERTICAL MODE switch to LEFT.
- CHECK**—for one trace per graticule division within 0.05 division of the error noted in part b, over the center 6 graticule divisions.

E3. CHECK VERTICAL LOW-FREQUENCY LINEARITY

NOTE

If the preceding step was not performed, first perform step E1, then proceed.

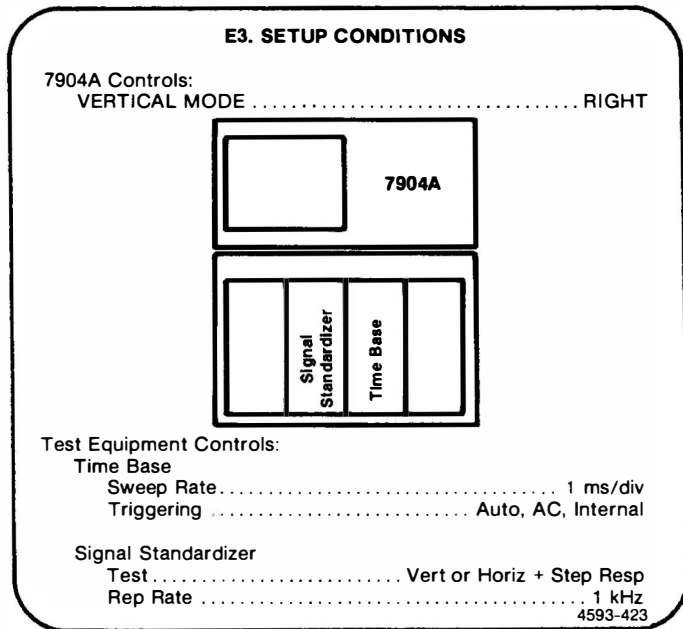

- a. Set the signal standardizer Amplitude and Position controls so the display is exactly two divisions in amplitude in the center of the graticule area.
- b. **CHECK**—position the two-division display vertically and check for not more than 0.1 division of compression or expansion anywhere within the graticule area.

E4. CHECK VERTICAL AMPLIFIER 500 MHz GAIN

NOTE

If the preceding step was not performed, first perform step E1, then proceed.

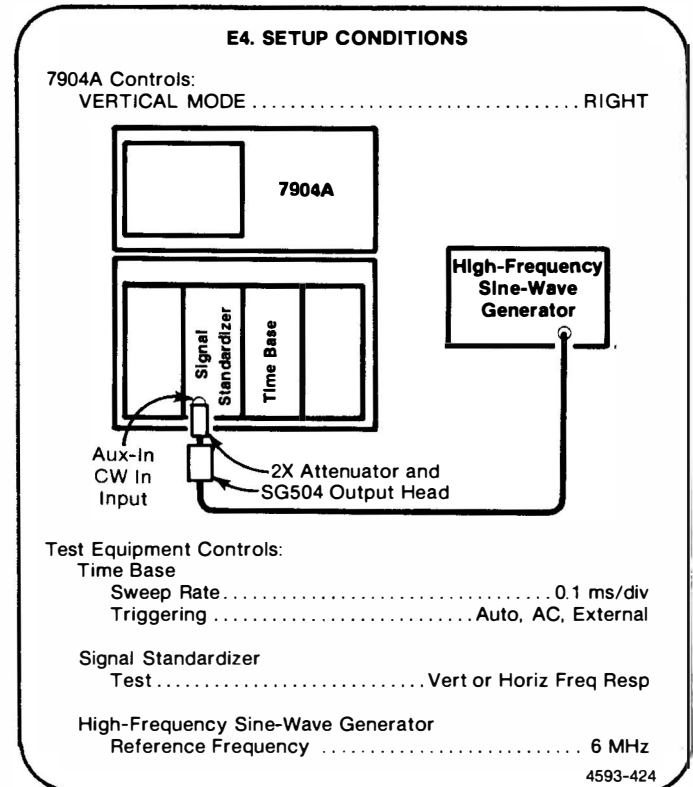

- a. Set the signal standardizer Amplitude control fully clockwise.
- b. Set the high-frequency sine-wave generator for a 10-division display at the reference frequency (between 6 and 50 megahertz) centered on the graticule. (To obtain a 10-division display, first obtain an eight-division display, then vertically position the display one division down and increase the output amplitude of the sine-wave generator so that the top of the display reaches the top of the graticule.)
- c. Set the signal standardizer Amplitude control for a six-division display, centered on the graticule. (The CW Leveled indicator should be lit.)
- d. Without changing the output amplitude, increase the generator frequency until the displayed amplitude is reduced to 4.6 divisions. If the CW Leveled indicator extinguishes, increase the amplitude of the sine-wave generator signal until the light just turns on.

Checks and Adjustment—7904A
Part I—Performance Check

NOTE

The signal standardizer CW Leveled light must be on and the sine-wave generator must be properly connected for a valid check. Refer to the signal standardizer and high-frequency sine-wave generator manuals.

- e. **CHECK**—sine-wave generator frequency is 500 MHz or higher (verifies 500 megahertz gain).
- f. Move the signal standardizer to the LEFT VERT compartment (leave signal connected) and set the VERTICAL MODE switch to LEFT.
- g. **CHECK**—repeat parts d. through f. for the LEFT VERT compartment.

E5. CHECK VERTICAL CHANNEL ISOLATION

NOTE

If the preceding step was not performed, first perform step E1, then proceed.

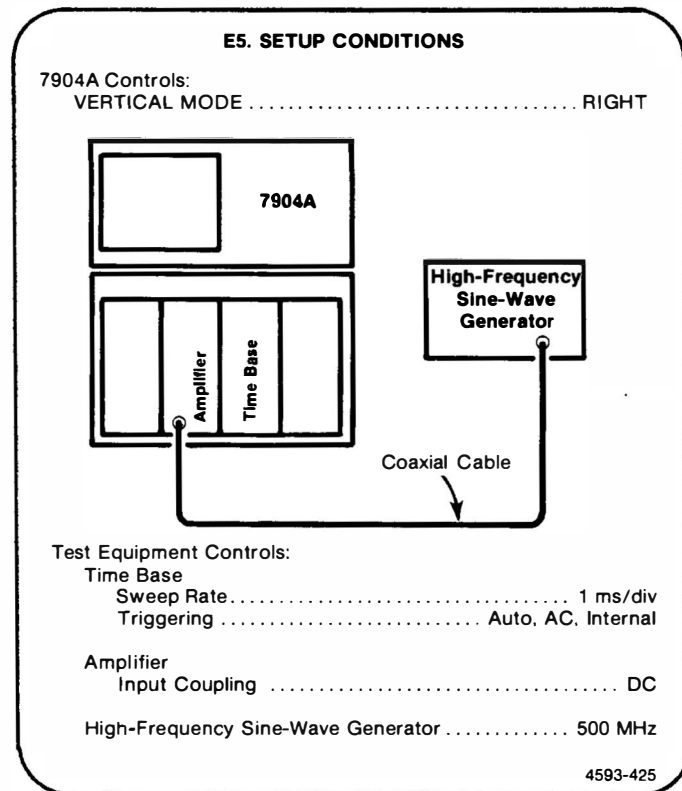

- a. Connect the output of the high-frequency sine-wave generator to the amplifier input.
- b. Set the output of the high-frequency sine-wave generator and the amplifier deflection factor for eight divisions of deflection at 500 MHz.
- c. Set the VERTICAL MODE switch to LEFT.
- d. **CHECK**—crt display amplitude for 0.1 division or less of the 500 MHz signal (verifies isolation of at least 80:1 at 500 MHz).
- e. Move the amplifier to the LEFT VERT compartment without changing any settings.
- f. Set the VERTICAL MODE switch to RIGHT.
- g. **CHECK**—crt display amplitude for 0.1 division or less of the 500 MHz signal (verifies isolation of at least 80:1 at 500 MHz). Disconnect the high-frequency sine-wave generator.
- h. Set the VERTICAL MODE switch to LEFT.

- i. Connect the medium-frequency sine-wave generator to the amplifier input.
- j. Set the medium-frequency sine-wave generator for eight divisions of deflection at 100 megahertz.
- k. Set the VERTICAL MODE switch to RIGHT.
- l. **CHECK**—crt display amplitude for 0.05 division or less of 100 megahertz signal (verifies 100 megahertz isolation of at least 160:1).
- m. Move the amplifier to the RIGHT VERT compartment without changing any settings.
- n. Set the VERTICAL MODE switch to LEFT.
- o. **CHECK**—crt display amplitude for 0.05 division or less of 100 megahertz signal (verifies isolation of at least 160:1 from dc to 100 megahertz).

E6. CHECK VERTICAL DISPLAY MODES

NOTE

If the preceding step was not performed, first perform step E1, then proceed.

E6. SETUP CONDITIONS

7904A Controls:
VERTICAL MODE RIGHT

7904A

Amplifier

Signal Standardizer

Time Base

Test Equipment Controls:

Time Base
Sweep Rate 1 ms/div
Triggering Auto, AC, Internal

Amplifier
Deflection Factor 0.1 V/div
Input Coupling DC

Signal Standardizer
Test Vert or Horiz Aux In

4593-426

- a. Position the trace to the upper half of the graticule area with the signal standardizer Position control.
- b. Set the VERTICAL MODE switch to LEFT and position the trace to the lower half of the graticule area with the amplifier Position control.
- c. **CHECK**—for two traces in the ALT and CHOP positions of the VERTICAL MODE switch.
- d. Set the VERTICAL MODE switch to ADD.
- e. **CHECK**—for a single trace that can be positioned vertically with either left or right vertical Position controls.

Checks and Adjustment—7904A
Part I—Performance Check

E7. CHECK VERTICAL TRACE SEPARATION
(B) OPERATION

NOTE

If the preceding step was not performed, first perform step E1, then proceed.

E7. SETUP CONDITIONS

7904A Controls:
HORIZONTAL MODE CHOP
VERTICAL MODE ADD

7904A

A
Time Base

B
Time Base

Test Equipment Controls:

A Time Base
Sweep Rate 1 ms/div
Triggering Auto, AC, Internal

B Time Base
Sweep Rate 1 ms/div
Triggering Auto, AC, Internal

4593-427

- a. **CHECK**—rotate the VERT TRACE SEPARATION (B) control throughout its range and check that the trace produced by the B time-base unit can be positioned above and below the trace produced by the A time-base unit by at least 3.5 divisions. Repeat with the HORIZONTAL MODE switch set to ALT.

F. READOUT SYSTEM

Equipment Required: (Numbers correspond to those listed in Table 5-3, Test Equipment.)

2. Amplifier, Dual-Channel

4. Time Base

F1. READOUT SYSTEM PRELIMINARY SETUP

- Perform the Performance Check Power-Up Sequence.
- Refer to Section 6, Instrument Options, and the Change Information at the rear of this manual for any modifications which may affect this procedure.
- Set the 7904A controls as follows:

| | |
|---|--|
| POWER switch | On |
| VERTICAL MODE | RIGHT |
| VERT TRACE SEPARATION (B) | Midrange |
| A TRIGGER SOURCE | VERT MODE |
| A INTENSITY | Midrange |
| HORIZONTAL MODE | A |
| B INTENSITY | Midrange |
| B TRIGGER SOURCE | VERT MODE |
| READOUT INTENSITY | OFF (in detent) |
| GRAT ILLUM | Midrange |
| BEAMFINDER | Pushbutton Out |
| Readout selector Switch (SN B031766 & Below) | Free Run (see Test Point and Adjustment Locations G.) |
| Readout Mode Plug P2112 (SN B031767 & Above) | Connect pins 1 & 2 (see Test Point and Adjustment Locations G.) |

F2. CHECK READOUT MODES

NOTE

First perform step F1, then proceed.

F2. SETUP CONDITIONS

7904A Controls:
HORIZONTAL MODE A

7904A

Test Equipment Controls:
Time Base 1 ms/div
Sweep Rate Auto, AC, Internal
Triggering 4593-428

- Set the READOUT INTENSITY control for a visible display.
- CHECK**—set the time-base to several sweep rates throughout its range, and check that the readout characters are displayed.
- Set the READOUT +GATE/EXT button to +GATE (pressed in) and set the READOUT INTENSITY control to PULSED.
- Set the OUTPUT +GATE button to A.
- Set the READOUT PRESET control for a visible readout display.
- Set the time-base for a free-running (not triggered) sweep at a rate of 0.2 second/division.

Checks and Adjustment—7904A
Part I—Performance Check

- g. **CHECK**—that the readout characters are blanked out while the sweep is running, and are displayed immediately after the end of the sweep; each character encoded by the plug-in units is displayed only once for each sweep.
- h. Set the READOUT +GATE/EXT button to EXT (released).

- i. **CHECK**—press the READOUT MAN pushbutton and notice that one frame of readout is displayed.

This completes the Part I—Performance Check Procedure.

PART II—ADJUSTMENT AND PERFORMANCE CHECK

The following procedure (Part II—Adjustment and Performance Check) provides the information necessary to: (1) verify that the instrument meets the electrical specifications, (2) verify that all controls function properly, and (3) perform all internal adjustments.

Part I—Performance Check verifies electrical specifications without removing instrument covers or making internal adjustments. All tolerances given are as specified in the Specification tables (section 1) in this manual.

A separate Operators Checkout Procedure is provided in Section 2 for familiarization with the instrument and also to verify that all controls, indicators and connectors function properly.

See Table 5-1, Checks and Adjustment Procedure Electives, at the beginning of this section, for information on performing a Partial Part II—Adjustment and Performance Check procedure.

INDEX TO ADJUSTMENT AND PERFORMANCE CHECK PROCEDURE

| | |
|---|--|
| <p>A. POWER SUPPLY</p> <p>1. Power Supply Preliminary Setup 5-35</p> <p>2. Adjust Preregulator (A12R93) 5-35</p> <p>3. Adjust +50 Volt Power Supply (A22R15) .. 5-36</p> <p>4. Examine Power Supply Voltages 5-37</p> <p>B. Z-AXIS AND DISPLAY</p> <p>1. Z-Axis and Display Preliminary Setup 5-38</p> <p>2. Adjust HV (A20R115)..... 5-38</p> <p>3. Adjust Z-Axis DC Levels (A21R135, A21R125)..... 5-39</p> <p>4. Adjust Z-Axis Transient Response (A21C180, A21C150, A21C155, A21R150, A21R155)..... 5-40</p> <p>5. Adjust Focus Level (A21R70)..... 5-41</p> <p>6. Adjust B Contrast (A2R2015)..... 5-42</p> <p>7. Check/Adjust Geometry, and Adjust Trace Alignment, Focus (A20R155, A20R55, A2R2025, A20R143, A29R122) 5-42</p> <p>8. Adjust Crt Grid Bias (A20R65) 5-43</p> <p>9. Adjust Auto-Focus Amplifier Gain (A21R63) 5-44</p> <p>10. Examine External Z-Axis Operation..... 5-44</p> <p>C. CALIBRATOR AND OUTPUT SIGNALS</p> <p>1. Calibrator and Output Signals Preliminary Setup 5-45</p> <p>2. Check/Adjust Calibrator Output Voltage (A5R385) 5-45</p> <p>3. Check/Adjust Calibrator 1 kHz Repetition Rate (A5R375)..... 5-46</p> <p>4. Check Calibrator Rise Time, Fall Time, and Duty Cycle 5-47</p> <p>5. Check A and B Sawtooth Output Signals 5-48</p> <p>6. Check A and B Gate Output Signals 5-48</p> <p>7. Check Graticule Illumination Operation.... 5-49</p> | <p>D. TRIGGER SYSTEM</p> <p>1. Trigger System Preliminary Setup 5-50</p> <p>2. Adjust A Trigger Selector Centering (A14R255, A14R270, A14R274, A14R279)... 5-50</p> <p>3. Adjust B Trigger Selector Centering and Gain (A14R455, A14R474, A14R479) 5-52</p> <p>4. Check/Adjust Vertical Signal Out DC Centering (A14R485, A14R480, A14R490) .. 5-53</p> <p>5. Check Trigger Selector Operation 5-54</p> <p>E. HORIZONTAL SYSTEM</p> <p>1. Horizontal System Preliminary Setup 5-55</p> <p>2. Adjust Horizontal Amplifier Limit Centering (A28R630) 5-55</p> <p>3. Adjust Horizontal Amplifier Centering (A28R121) 5-56</p> <p>4. Check/Adjust Horizontal Gain and Low Frequency Linearity (A28R230) 5-56</p> <p>5. Adjust Readout Centering and Gain (A28R114, A28R101)..... 5-57</p> <p>6. Check/Adjust High-Frequency Timing (A28C810, A28C850, A28C310, A28C340, A28R312, A28R340, A28C922) 5-58</p> <p>7. Adjust Horizontal Readout Jitter (A28R240) 5-59</p> <p>8. Check/Adjust X-Y Delay Compensation (A17C804, A17C814)..... 5-60</p> <p>F. VERTICAL SYSTEM</p> <p>1. Vertical System Preliminary Setup..... 5-61</p> <p>2. Adjust Vertical Amplifier Centering (A18R736, A16R535) 5-61</p> <p>3. Check/Adjust Vertical Amplifier Gain (A18R211) 5-62</p> <p>4. Check Vertical Low-Frequency Linearity..... 5-62</p> <p>5. Adjust Thermal Compensations (A18R130, A18C200, A18R238, A18R335, A18R237, A18R132, A18R131) 5-63</p> |
|---|--|

Checks and Adjustment—7904A
Part II—Adjustment and Performance Check

| | |
|---|------|
| 6. Adjust Channel Switch Compensation (A16C538, A16R530, A16R525, A16R520, A16R515, A16R512, A16C638, A16R630, A16R625, A16R620, A16R615, A16R612) ... | 5-64 |
| 7. Adjust High-Frequency Compensation (A18R404, A18R405, A18C401, R83, A18R215, A18C215, A18L100)..... | 5-65 |
| 8. Check Vertical Amplifier 500 MHz Gain ... | 5-66 |
| 9. Check Vertical Channel Isolation..... | 5-67 |
| 10. Check Vertical Display Modes..... | 5-68 |
| 11. Check Vertical Trace Separation (B) Operation | 5-68 |
| G. READOUT SYSTEM | |
| 1. Readout System Preliminary Setup..... | 5-69 |
| 2. Adjust Readout Vertical Separation, Centering and Character Height (A15R2291, A18R737, A15R2273, A28R101, A28R114)..... | 5-69 |
| 3. Adjust Character Scan (A15R2128)..... | 5-70 |
| 4. Adjust Column and Row Match (A15R2214, A15R2183)..... | 5-71 |
| 5. Check Readout Modes..... | 5-71 |

**ADJUSTMENT AND PERFORMANCE
CHECK POWER-UP SEQUENCE**

NOTE

The performance of this instrument can be checked at any ambient temperature from 0° to +50° C unless otherwise stated. Adjustments must be performed at an ambient temperature from +20° to +30° C for the specified accuracies.

1. Check that the 7904A has been set for the proper power source and also that a suitable power cord and plug has been attached. Refer to Power Source Information in Section 1—General Information for specific details.
2. Remove cabinet panels to gain access to internal adjustments and test points. For instruments with serial numbers below B040000, remove fan blade from motor by gently pulling blade off motor shaft.
3. Connect the 7904A to a suitable power source.
4. Press the POWER button and allow at least 20 minutes warmup before proceeding.



To prevent instrument damage, turn off 7904A POWER before installing or removing plug-in units.

A. POWER SUPPLY

Equipment Required: (Numbers correspond to those listed in Table 5-3, Test Equipment.)

- | | |
|--|---------------------------|
| 5. Precision DC Voltmeter (DVM) | 16. Screwdriver, Phillips |
| 9. Plug-In Extender (optional for this procedure) | 19. Tool, Alignment |

A1. POWER SUPPLY PRELIMINARY SETUP

- Perform the Adjustment and Performance Check Power-Up Sequence.
- Refer to Section 6, Instrument Options, and the Change Information at the rear of this manual for any modifications which may affect this procedure.
- See the **TEST POINT AND ADJUSTMENT LOCATIONS A** foldout page in Section 8, Diagrams and Circuit Board Illustrations.
- Set the 7904A controls as follows:

POWER On (pushbutton in)
 VERTICAL MODE LEFT
 VERT TRACE SEPARATION (B) Midrange
 A TRIGGER SOURCE VERT MODE
 A INTENSITY Fully counterclockwise
 HORIZONTAL MODE A
 B INTENSITY Fully counterclockwise
 B TRIGGER SOURCE VERT MODE
 FOCUS Midrange
 READOUT intensity OFF (in detent)
 GRAT ILLUM Fully counterclockwise
 CONTROL ILLUM MEDIUM (rear panel)

A2. ADJUST PREREGULATOR (A12R93)

NOTE

First perform step A1, then proceed.

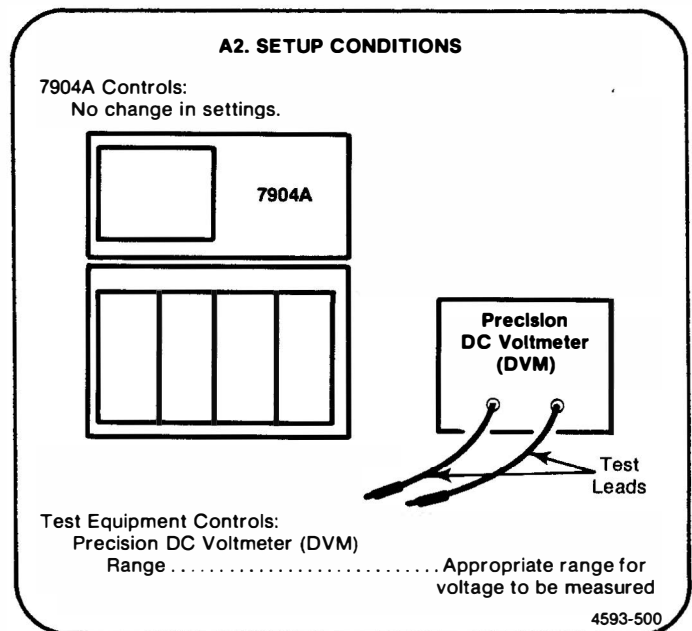

- Connect the precision dc voltmeter (DVM) between TP126 (located on the A12 Control Rectifier Board) and chassis ground. Access to TP126 is through the A12R93 Pre Reg Adj hole (marked R1293 on the panel) in the bottom of the power supply unit.
- EXAMINE**—the meter for a reading of +108 volts, within the limits of +107.5 to +108.5 volts. If the meter reading is within the given tolerance, proceed to step A3.
- ADJUST**—Pre Reg Adj, R93 (marked R1293 on the panel, and located on the A12 Control Rectifier Board) for a meter reading of +108 volts.
- INTERACTION**—any change in the setting of R93 may affect the adjustment of R15 given in step A3.

Checks and Adjustment—7904A
Part II—Adjustment and Performance Check

A3. ADJUST +50 VOLT POWER SUPPLY
(A22R15)

NOTE

If the preceding step was not performed, first perform step A1, then proceed.

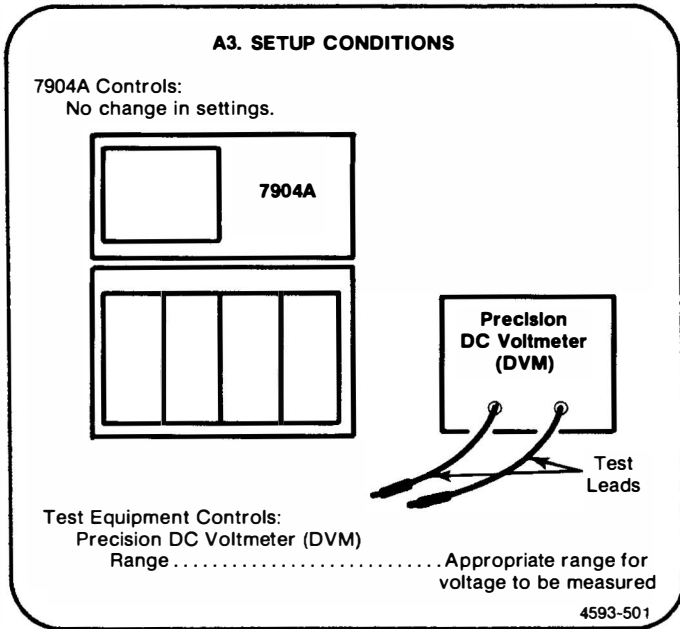

WARNING

Extreme caution must be used when operating the 7904A with the power unit removed due to the line voltage, high voltage, and high currents present.

NOTE

The Power Supply voltages can be checked without removing the power unit by using a rigid 7000-series plug-in extender. Refer to Table 5-3, Test Equipment.

- Set the POWER switch to OFF and disconnect the line cord from the power source. Remove any plug-in units from the plug-in compartments. Expose the 7904A power supply adjustments and test points by removing the power unit from the rear of the 7904A (interconnecting cables remain connected). See the Maintenance section in this manual for power unit removal instructions.
- Connect the line cord to the power source and press the POWER button.
- Connect the precision dc voltmeter (DVM) between TP -50 V Sense and TP Gnd Sense on the A22 Low-Voltage Regulator circuit board.
- EXAMINE**—the meter for a reading of -50 volts, within the limits of -49.8 to -50.2 volts.
- ADJUST**—the +50 V adjustment, R15 (located on the A22 Low Voltage Regulator Board) for a meter reading of -50 volts.
- INTERACTION**—any change in the setting of R15 may affect the operation of all circuits in the instrument.

A4. EXAMINE POWER SUPPLY VOLTAGES

NOTE

If the preceding step was not performed, first perform step A1, then proceed.

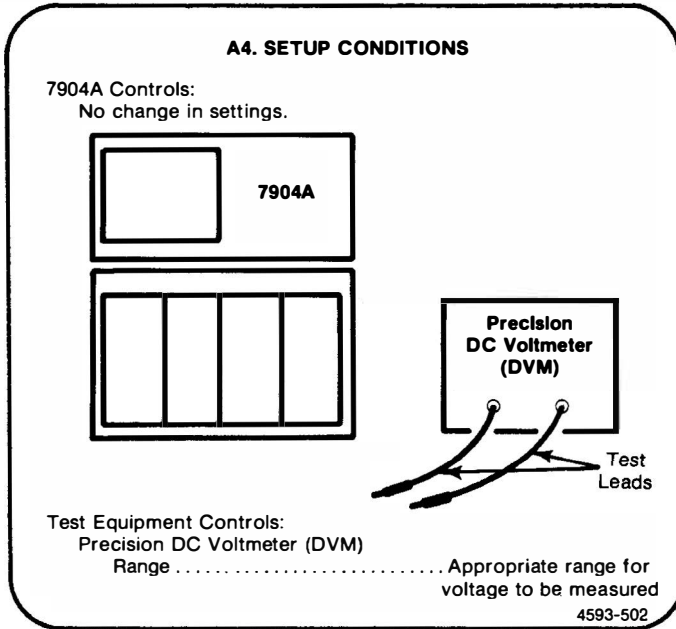

- a. **EXAMINE**—Table 5-4 lists the tolerance of the low-voltage power supplies in the 7904A. Check each supply with the DVM (precision dc voltmeter) for output voltage within the given tolerance. Connect meter common lead to TP Gnd Sense. Test points are located on the A22 Low-Voltage Regulator Board.

TABLE 5-4
Power Supply Tolerances

| Power Supply | Output Voltage Limits |
|-----------------------|------------------------|
| TP -50 V Sense (-50S) | -49.8 to -50.2 volts |
| TP -15 V Sense (-15S) | -14.85 to -15.15 volts |
| TP +5 V Sense (+5S) | +4.9 to +5.1 volts |
| TP +15 V Sense (+15S) | +14.85 to +15.15 volts |
| TP +50 V Sense (+50S) | +49.5 to +50.5 volts |

- b. **INTERACTION**—if the power supplies are not within the tolerances given in Table 5-4, repeat steps A1 and A2.
- c. Disconnect the precision dc voltmeter.

NOTE

Regulation of the individual power supplies can be checked using the procedure given under Troubleshooting Techniques in the Maintenance section.

- d. Turn the 7904A off.
- e. Disconnect the line cord from the power source.
- f. Reinstall the power unit and reconnect the line cord.

B. Z-AXIS AND DISPLAY

Equipment Required: (Numbers correspond to those listed in Table 5-3, Test Equipment.)

- | | |
|---------------------------------------|--|
| 1. Test Oscilloscope (with 10X probe) | 13. Coaxial Cable (two 42-inch required) |
| 3. Amplifier | 15. Adapter, BNC T |
| 4. Time-Base (two required) | 16. Screwdriver, Phillips |
| 5. Precision DC Voltmeter (DVM) | 17. Screwdriver, Slotted |
| 6. Low-Frequency Sine-Wave Generator | 19. Tool, Alignment |
| 10. Signal Standardizer (two needed) | |

B1. Z-AXIS AND DISPLAY PRELIMINARY SETUP

- Perform the Adjustment and Performance Check Power-Up Sequence.
- Refer to Section 6, Instrument Options, and to the Change Information at the rear of this manual for any modifications which may affect this procedure.
- See the **TEST POINT AND ADJUSTMENT LOCATIONS B** foldout page in Section 8, Diagrams and Circuit Board Illustrations.
- Set the 7904A controls as follows:

POWER.....On (pushbutton in)
 VERTICAL MODE.....LEFT
 VERT TRACE SEPARATION (B).....Midrange
 A TRIGGER SOURCE.....VERT MODE
 A INTENSITY.....Fully counterclockwise
 HORIZONTAL MODE.....A
 B INTENSITY.....Fully counterclockwise
 B TRIGGER SOURCE.....VERT MODE
 FOCUS.....Midrange
 READOUT.....OFF (in detent)
 GRAT ILLUM.....Midrange
 CONTROL ILLUMINATION.....MEDIUM
 (rear panel)

WARNING

Extreme care must be used when making the following adjustments because dangerous potentials are present.

B2. ADJUST HV (A20R115)

NOTE

First perform step B1, then proceed.

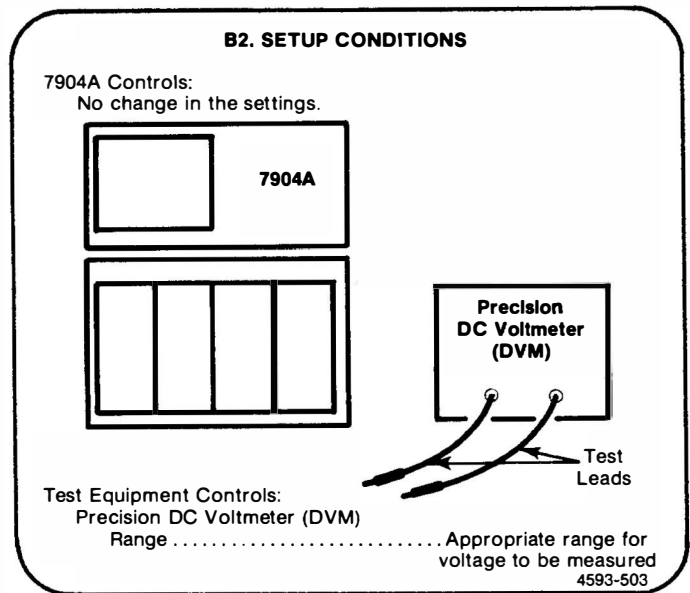

- Temporarily set the POWER switch to OFF and remove the A20 High Voltage Board shield (secured by three screws). Connect the precision dc voltmeter (DVM), set to measure at least +130 volts, between TP127 (located on the A20 High Voltage Board) and chassis ground.

WARNING

Extreme caution must be used when making the following adjustments due to the dangerous potentials present.

- Press the POWER button to on.
- EXAMINE**—the voltmeter for a reading of 96 to 104 volts.

- d. **ADJUST**—HV Adj, R115 (located on the A20 High Voltage Board), for 100 volts on the voltmeter.
- e. Press POWER button to OFF.
- f. Remove the DVM test leads and re-install the A20 High Voltage Board shield.
- g. Press POWER button to on.

**B3. ADJUST Z-AXIS DC LEVELS
(A21R135, A21R125)**

NOTE

If the preceding step was not performed, first perform step B1, then proceed.

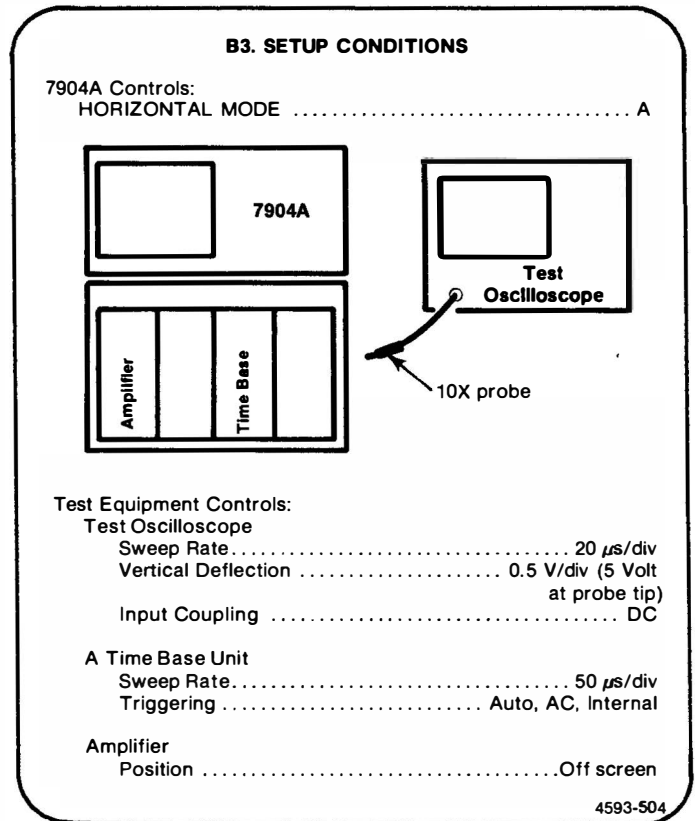

- a. Set the test oscilloscope input coupling to ground. Move the ground reference trace to the bottom graticule of the test oscilloscope display. Return the test oscilloscope input coupling to dc.
- b. Connect the test oscilloscope 10X probe to TP183 (located on the A21 Z-Axis Board) with the probe ground connected to chassis ground.
- c. **EXAMINE**—test oscilloscope display for a waveform baseline between 8 and 12 volts above ground reference.
- d. **ADJUST**—the Output Level, R135 (located on the A21 Z-Axis Board), for a waveform base line at 10 volts above ground reference.
- e. Set the 7904A A INTENSITY control fully clockwise and set the test oscilloscope vertical deflection to 1 volt/division (10 volts/division at the probe tip).
- f. **EXAMINE**—the test oscilloscope display for a 61 to 65 volt peak-to-peak waveform. (Do not move the test oscilloscope vertical Position control.)

Checks and Adjustment—7904A
Part II—Adjustment and Performance Check

- g. **ADJUST**—the Z-Axis Ampl Gain adjustment, R125 (located on the A21 Z-Axis Board) for a 63-volt peak-to-peak waveform displayed on the test oscilloscope.
- h. **INTERACTION**—repeat parts (d) through (g) until the waveform is within the limits specified in parts (d) and (f).
- i. Disconnect the probe.

B4. ADJUST Z-AXIS TRANSIENT RESPONSE (A21C180, A21C150, A21C155, A21R150, A21R155)

NOTE

If the preceding step was not performed, first perform step B1, then proceed.

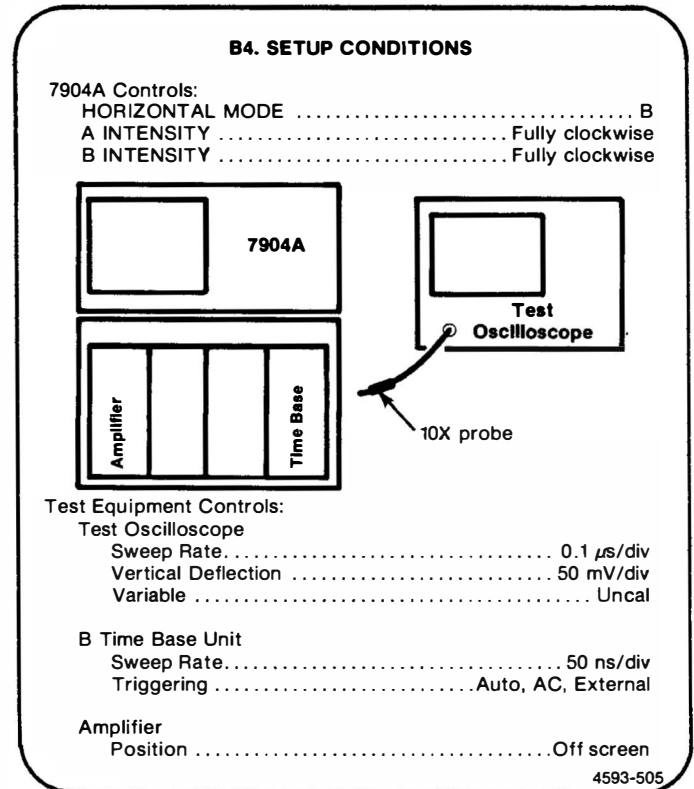

- a. Connect the test oscilloscope 10X probe tip to TP186 (located on the A21 Z-Axis Board) and the probe ground to chassis ground.
- b. With the test oscilloscope triggered on the rising edge of the signal, use the test oscilloscope variable Gain and Position controls to obtain an 8-division display centered on the graticule.
- c. Set the 7904A B INTENSITY control for a 6-division display on the test oscilloscope. Position the display to view the leading edge of the waveform at the center graticule lines.
- d. **EXAMINE**—the test oscilloscope display for optimum square corner and flat top on the displayed pulse. Aberrations should be less than 5% peak-to-peak (0.3 division).
- e. **ADJUST**—Comp 5 (C180) for flat top and Comp 1 (C150), Comp 2 (R150), Comp 3 (R155), and Comp 4 C155 (located on the A21 Z-Axis Board) for optimum square corner of the displayed pulse (use low-capacitance alignment tool to adjust variable capacitors).

- f. Set the B INTENSITY control for 1.5 divisions of display on the test oscilloscope.
- g. **EXAMINE**—test oscilloscope display for less than 5% aberration (0.75 division).
- h. **ADJUST**—R150 and C150 (located on the A21 Z-Axis Board) for optimum square corner at 1.5 divisions of displayed pulse.
- i. Set the B INTENSITY control for a 6-division display on the test oscilloscope.
- j. Set the test oscilloscope sweep rate to 10 ns/division.
- k. **EXAMINE**—the pulse rise time for 9 to 15 nanoseconds (measured between the 10% and 90% amplitude points of the pulse).
- l. **INTERACTION**—the adjustments in parts e and h affect the pulse rise time. If rise time is not within the stated limits, repeat parts (e) through (k).
- m. Disconnect the probe.

B5. ADJUST FOCUS LEVEL (A21R70)

NOTE

If the preceding step was not performed, first perform step B1, then proceed.

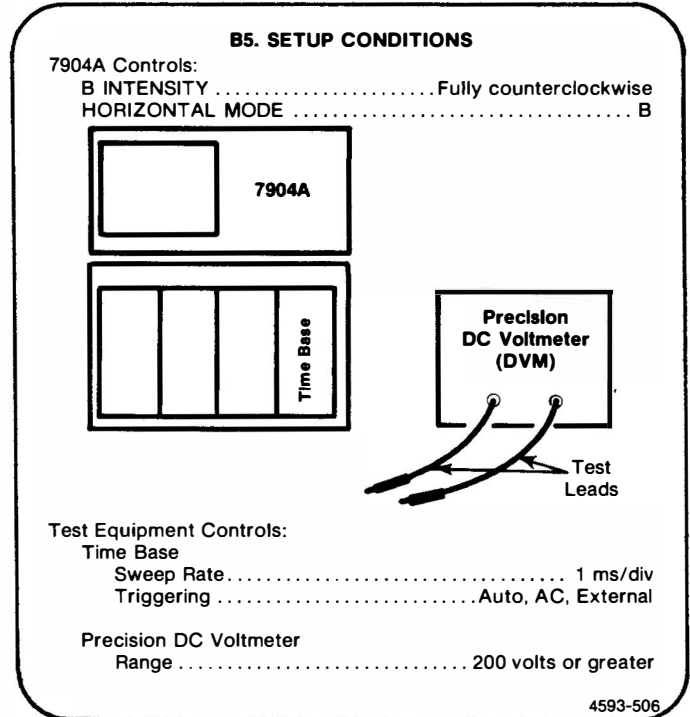

- a. Connect the precision dc voltmeter (DVM), set to measure 200 volts, between TP83 (located on the A21 Z-Axis Board) and chassis ground. (The B INTENSITY control must be in the counterclockwise position.)
- b. **EXAMINE**—the voltmeter for a reading of 120 to 126 volts.
- c. **ADJUST**—Focus Output Level adjustment, R70 (located on the A21 Z-Axis Board), for a voltmeter reading of 123 volts.
- d. Remove the DVM test leads.

B6. ADJUST B CONTRAST (A2R2015)

NOTE

If the preceding step was not performed, first perform step B1, then proceed.

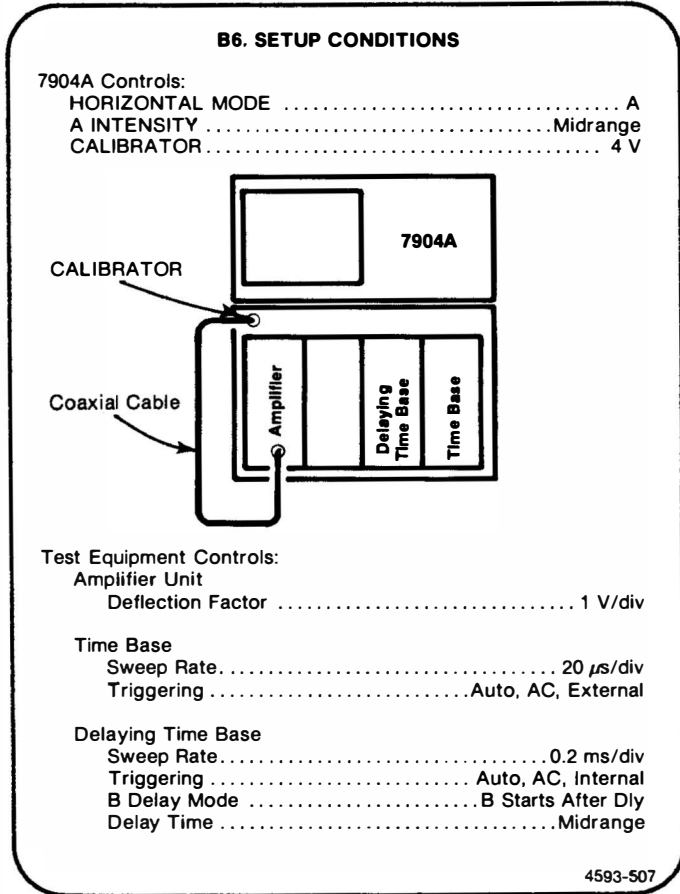

- a. Center the square-wave display on the crt graticule using the amplifier Position control and set the A INTENSITY control for a normal viewing level.
- b. Set the delaying time-base unit Triggering controls for a stable display.
- c. Set the delaying time-base unit Delay Time control to mid-range.
- d. **EXAMINE**—the crt display while rotating the B CONTRAST adjustment, R2015 (front-panel screwdriver adjustment), through its entire range. Notice the change in the intensity of the “intensified” portion of the waveform.
- e. **ADJUST**—the B CONTRAST adjustment, R2015, for a well-defined intensified zone on the displayed trace.

B7. CHECK/ADJUST GEOMETRY, AND ADJUST TRACE ALIGNMENT FOCUS, (A20R155, A20R55, A2R2025, A20R143, A29R122)

NOTE

If the preceding step was not performed, first perform step B1, then proceed.

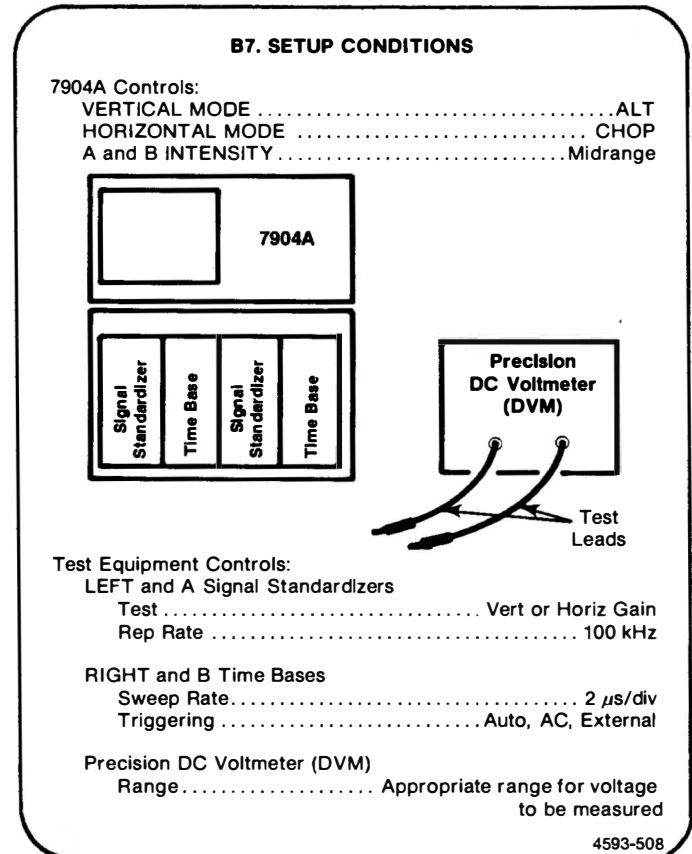

- a. Set both signal standardizer Position controls to superimpose the crosshatch display over the vertical and horizontal graticule center lines.
- b. Set FOCUS control to midrange.
- c. Temporarily set the POWER switch to OFF and remove the A20 High Voltage Board shield (secured by three screws). Connect the precision dc voltmeter (DVM), set to measure at least +36 volts, between TP156 (on the A20 High Voltage Board) and chassis ground.
- d. Press the POWER button to on.
- e. Set the VERTICAL MODE switch to ALT and the HORIZONTAL MODE switch to CHOP.
- f. **EXAMINE**—the voltmeter for a reading of +34 to +36 volts.

- g. **ADJUST**—Shield Volts adjustment, R155 (on the A20 High Voltage Board), for +34.5 volts on the DVM.
- h. **ADJUST**—the Focus Preset, R55 (on the A20 High-Voltage Board), and the front-panel ASTIG adjustment, R2025 (on the A2 Display Control Board), for the best overall resolution of the traces.
- i. **INTERACTION**—poor focus at one edge of the display may be improved by compromising the Shield Volts and Focus Preset adjustments, parts (g) and (h).
- j. Disconnect the precision dc voltmeter (DVM).
- k. Set the front-panel FOCUS and INTENSITY controls for a well-defined display.
- l. **CHECK**—that the vertical and horizontal traces which cross at graticule center are aligned with the graticule vertical and horizontal center lines, within 0.1 division.
- m. **ADJUST**—the Y-Axis Align adjustment, R122 (on the A29 Horizontal Interface Board), and the front-panel TRACE ROTATION adjustment, R2035 (on the A2 Display Control Board), to align the vertical and horizontal traces with the graticule horizontal and vertical center lines. (The Y-Axis Align adjustment, R122, is accessible using a thin bladed screwdriver, from the side of the instrument just forward of and below the fan.)
- n. **CHECK**—the horizontal trace at the top and bottom of the graticule for 0.1 division or less of bowing or tilt.
- o. **ADJUST**—Geom adjustment, R143 (on the A20 High Voltage Board), for minimum bowing of the traces at the top and bottom of the graticule.
- p. Press the POWER button to OFF and re-install the High Voltage Board shield.
- q. Press the POWER button to on.

B8. ADJUST CRT GRID BIAS (A20R65)

NOTE

If the preceding step was not performed, first perform step B1, then proceed.

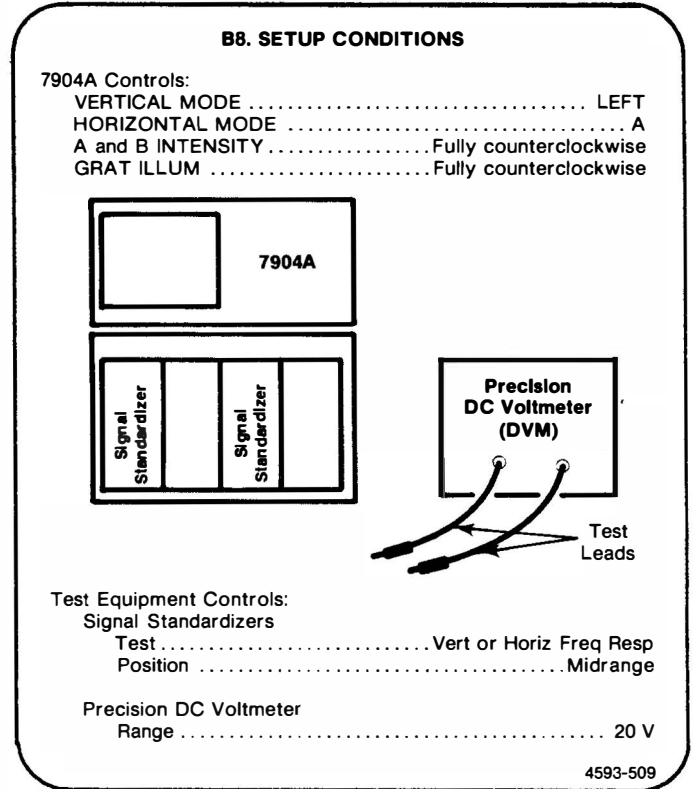

- a. Connect the precision dc voltmeter (DVM) between test point TP183 (located on the A21 Z-Axis Board) and chassis ground and note the voltage reading.
- b. **EXAMINE**—crt display while advancing the A INTENSITY control setting. A spot on the crt should become barely visible at 3.6V to 4.4V above the voltage noted in part a.
- c. Set the A INTENSITY control so that the dc voltage at TP183 is 4 volts above the voltage noted in part a.
- d. Disconnect the DVM.
- e. **ADJUST**—Grid Bias Adjustment, R65 (located on the A20 High Voltage Board) to barely extinguish the spot on the crt.

B9. ADJUST AUTO-FOCUS AMPLIFIER GAIN (A21R63)

NOTE

If the preceding step was not performed, first perform step B1, then proceed.

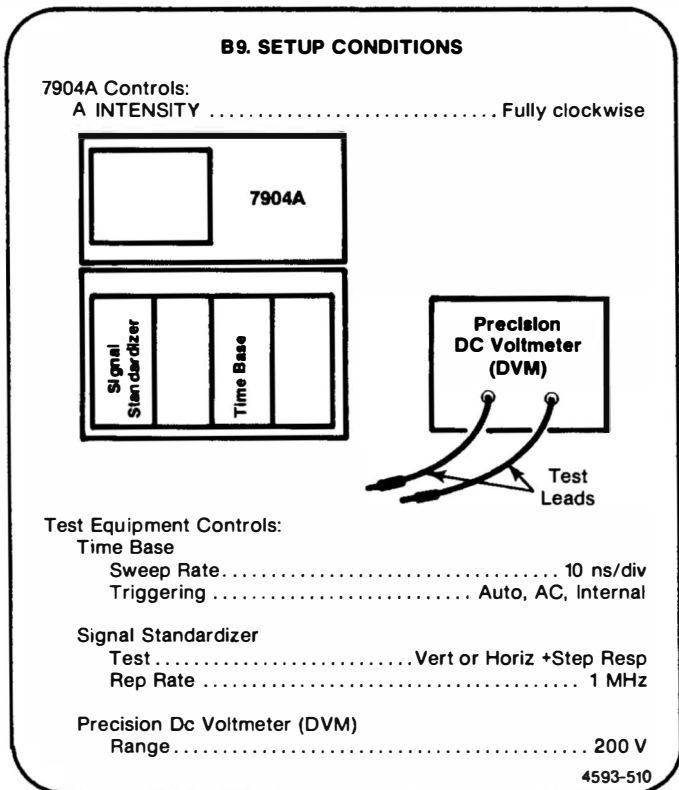

- a. Connect the precision dc voltmeter (DVM) between TP83 (on the A21 Z-Axis Board) and ground.
- b. Set the signal standardizer Amplitude and Position controls for a 3-division square wave, centered on the crt.
- c. Set the time base Triggering controls for a stable display triggered on the rising edge.
- d. **EXAMINE**—the crt display for objectionable defocusing of the crt display.
- e. **ADJUST**—the Focus Gain adjustment, R63 (on the A21 Z-Axis Board), for optimum focusing of the high-intensity trace.
- f. **EXAMINE**—the voltmeter for a reading greater than (more positive) -12 volts.
- g. **ADJUST**—if optimum focus of trace occurs below (more negative) -12 volts, compromise the setting of R63 until voltmeter reading is -12 volts.
- h. Disconnect the DVM.

B10. EXAMINE EXTERNAL Z-AXIS OPERATION

NOTE

If the preceding step was not performed, first perform step B1, then proceed.

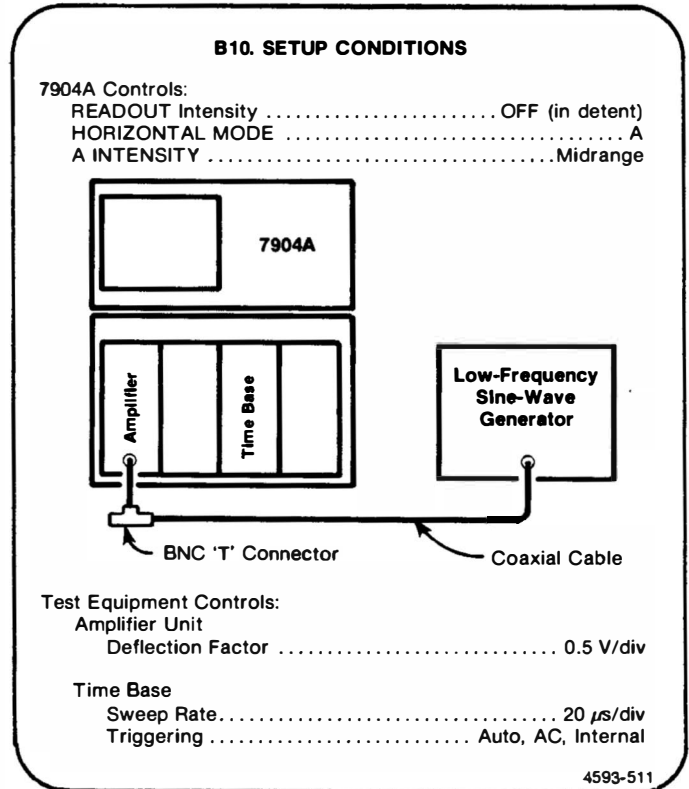

- a. Set the low-frequency sine-wave generator for a 4-division display at 50 kilohertz (one volt above and below ground).
- b. Set the A INTENSITY control for a dim display.
- c. Connect the signal from the output of the bnc T-connector at the amplifier input to the Z-AXIS INPUT connector on the rear panel with a coaxial cable.
- d. **EXAMINE**—the positive portion of the displayed waveform is blanked.

C. CALIBRATOR AND OUTPUT SIGNALS

Equipment Required: (Numbers correspond to those listed in Table 5-3, Test Equipment.)

- | | |
|---------------------------------|--|
| 1. Test Oscilloscope | 13. Coaxial Cables (four 42-inch required) |
| 4. Time-Base | 15. Adapter, BNC T |
| 5. Precision DC Voltmeter (DVM) | 19. Tool, Alignment |
| 11. Time-Mark Generator | |

C1. CALIBRATOR AND OUTPUT SIGNALS PRELIMINARY SETUP

- Perform the Adjustment and Performance Check Power-Up Sequence.
- Refer to Section 6, Instrument Options, and the Change Information at the rear of this manual for any modifications which may affect this procedure.
- See the **TEST POINT AND ADJUSTMENT LOCATIONS C** foldout page in Section 8, Diagrams and Circuit Board Illustrations.
- Set the 7904A controls as follows:

POWER switch On
 VERTICAL MODE RIGHT
 VERT TRACE SEPARATION (B) Midrange
 A TRIGGER SOURCE VERT MODE
 A INTENSITY Fully counterclockwise
 HORIZONTAL MODE A
 B INTENSITY Fully counterclockwise
 B TRIGGER SOURCE VERT MODE
 READOUT INTENSITY OFF (in detent)
 GRAT ILLUM Midrange
 BEAMFINDER Pushbutton out
 CALIBRATOR 4 V pushbutton in

C2. CHECK/ADJUST CALIBRATOR OUTPUT VOLTAGE (A5R385)

NOTE

First perform step C1, then proceed.

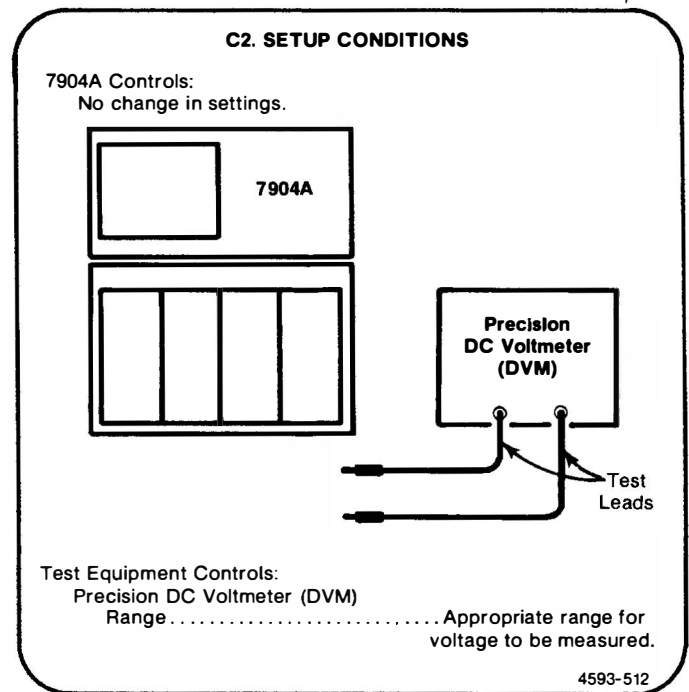

- Set the 4 V and 0.4 V CALIBRATOR pushbuttons to the pressed-in position.
- Connect the precision dc voltmeter (DVM) to the CALIBRATOR output connector.
- CHECK**—for a DVM reading of 0.4008 volt, within the limits of 0.4004 to 0.4012 volt.
- ADJUST**—the 0.4 V ADJ, R385 (on the A5 Mode Switch Board) for a meter reading of exactly 0.4008 volt. (Access to adjustment is through the chassis, inside the right vertical compartment, near the front of the instrument and under the VERTICAL MODE switch.)

Checks and Adjustment—7904A
Part II—Adjustment and Performance Check

C3. CHECK/ADJUST CALIBRATOR 1 kHz REPETITION RATE (A5R375)

NOTE

If the preceding step was not performed, first perform step C1, then proceed.

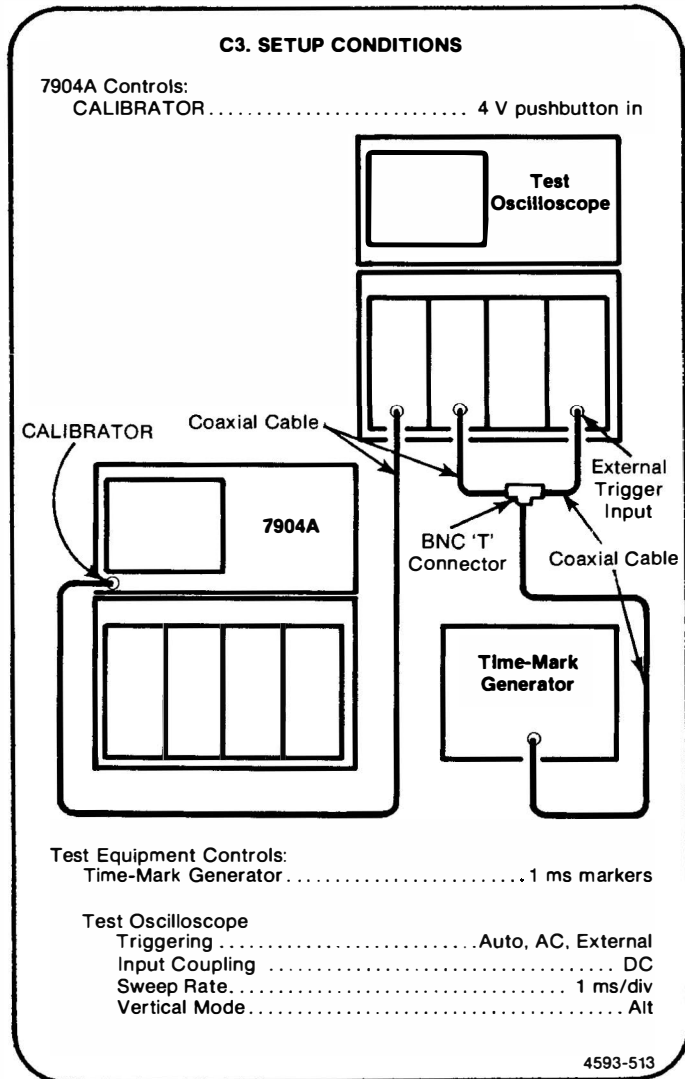

NOTE

A frequency counter with an accuracy of at least 0.1% may be used to adjust the CALIBRATOR repetition rate.

- a. Connect 1-millisecond time-markers to the test oscilloscope external trigger input and to the noninverting vertical channel of the test oscilloscope (use a bnc T connector). Connect the 7904A CALIBRATOR output to the inverting input of the test oscilloscope.
- b. Set the test oscilloscope Triggering Level control for a stable time-mark display.
- c. Set the test oscilloscope vertical deflection factors to display 2 divisions of CALIBRATOR signal and 1 division of time-marker signal.
- d. Set the test oscilloscope Vertical Mode to Add.
- e. Set the test oscilloscope sweep rate for 0.2 second/division.
- f. **CHECK**—that the time required for the 1-millisecond time marks to drift from the positive level of the CALIBRATOR signal to the negative level and back to the positive level, is more than 0.4 second (2 divisions). This time can be measured directly from the display by observing the number of divisions that the markers move across the display area before it returns to the positive level.
- g. **ADJUST**—1 kHz adjustment, R375 (on the A5 Mode Switch Board) for minimum drift (access to the adjustment is through the inside top of the vertical compartment).

C4. CHECK CALIBRATOR RISE TIME, FALL TIME, AND DUTY CYCLE

NOTE

If the preceding step was not performed, first perform step C1, then proceed.

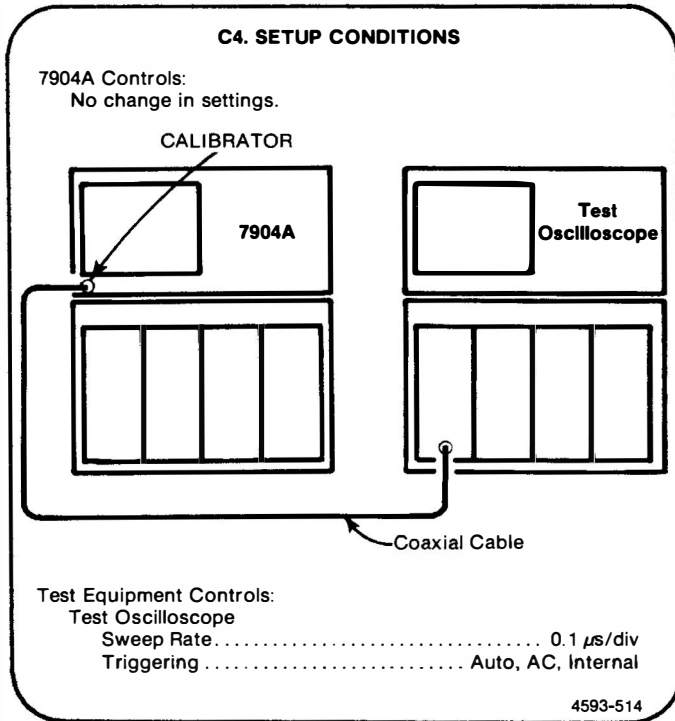

- a. Connect the CALIBRATOR output to the inverting vertical input of the test oscilloscope.
- b. Set the test oscilloscope vertical deflection to display 4 divisions of CALIBRATOR signal.
- c. Set the test oscilloscope for a stable display, triggered on the rising portion of the CALIBRATOR signal.

- d. **CHECK**—the displayed waveform for not more than 5 divisions horizontally between the 10% to 90% points of the waveform (rise time, 0.5 microsecond or less).
- e. Set the test oscilloscope for a stable display triggered on the falling portion of the waveform.
- f. **CHECK**—the displayed waveform for not more than 5 divisions between the 90% and 10% amplitude points (fall time, 0.5 microsecond or less).
- g. Set the test oscilloscope triggering for positive slope and auto mode with ac coupling from the internal source at a sweep rate of 0.1 millisecond/division. Set the triggering controls so that the display starts at the 50% point on the rising edge of the waveform.
- h. Set the test oscilloscope sweep magnifier to X10. Then, position the display horizontally so the falling edge of the waveform aligns with the center vertical graticule line.
- i. Set the test oscilloscope vertical to invert the display.

NOTE

The display is triggered on the opposite slope, even though the display appears the same.

- j. **CHECK**—that the 50% point on the falling edge of the waveform now displayed is within 0.2 divisions horizontally of the center line. (Indicates duty cycle of 50% within 0.2%.)

Checks and Adjustment—7904A
Part II—Adjustment and Performance Check

C5. CHECK A AND B SAWTOOTH OUTPUT SIGNALS

NOTE

If the preceding step was not performed, first perform step C1, then proceed.

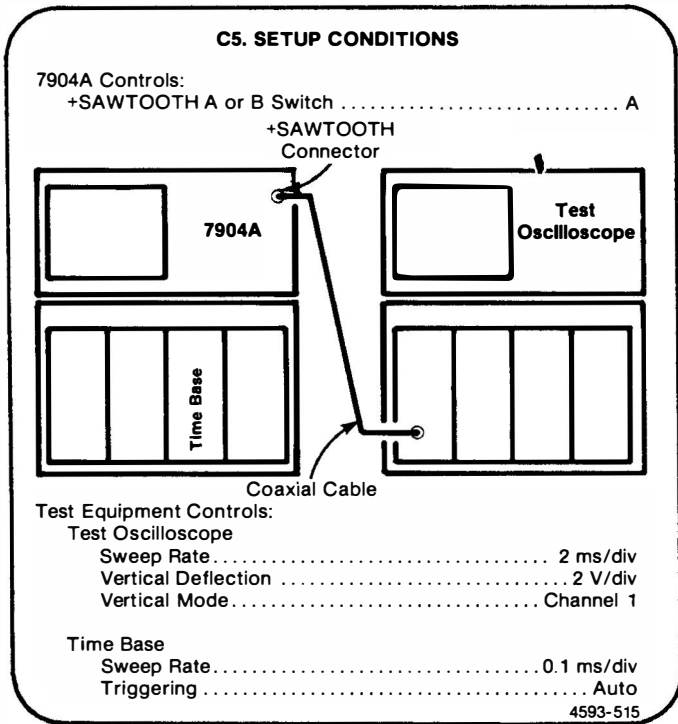

- Connect the +SAWTOOTH output connector to the test oscilloscope channel 1 vertical input (one-megohm input).
- CHECK**—that the slope of the test oscilloscope display rises 2 volts/horizontal division, within 10% (10-volt sawtooth for 10 division sweep on 7904A crt screen) and that the sawtooth baseline is within one volt of ground.
- Move the time base to the B HORIZ compartment.
- Set the +SAWTOOTH selector switch to the B position.
- CHECK**—the test oscilloscope display for 2 volts/division of sweep within 10% (10-volt sawtooth for 10 division sweep on the 7904A crt screen) and that the sawtooth baseline is within one volt of ground.

C6. CHECK A AND B GATE OUTPUT SIGNALS

NOTE

If the preceding step was not performed, first perform step C1, then proceed.

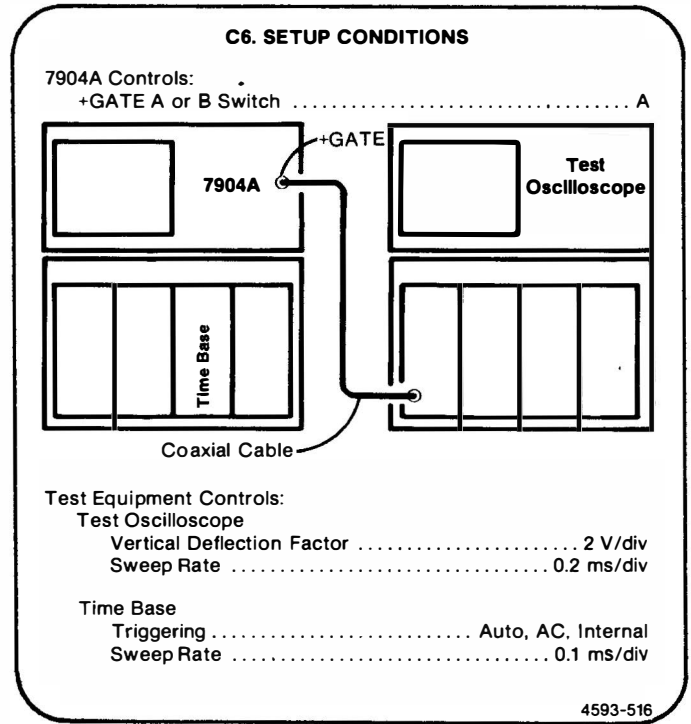

- CHECK**—the test oscilloscope display for a gate waveform 5 divisions in amplitude, within 10%, and a baseline at zero volts, within one volt.
- Move the time-base unit to the B HORIZ compartment.
- Set the +GATE selector switch to the B position.
- CHECK**—the test oscilloscope display for a gate waveform 5 divisions in amplitude, within 10%, and a baseline at zero volts, within one volt.

C7. CHECK GRATICULE ILLUMINATION OPERATION

NOTE

If the preceding step was not performed, first perform step C1, then proceed.

C7. SETUP CONDITIONS

7904A Controls:
 GRAT ILLUM + GATE or EXT Switch+GATE
 +GATE A or B Switch A
 HORIZONTAL MODE A

Test Equipment Controls:
 Time Base
 Sweep Rate 0.2 s/div
 Triggering Auto, AC, Internal

4593-517

- a. **CHECK**—that rotating the GRAT ILLUM control throughout its range varies the illumination of the graticule.
- b. Set the GRAT ILLUM control fully clockwise to the PULSED detent position.
- c. Set the A INTENSITY control for a visible display.
- d. **CHECK**—that graticule illumination occurs only after the time-base has completed a sweep (adjust GRAT ILLUM PRESET, if necessary).
- e. Set the GRAT ILLUM +GATE or EXT switch to EXT.
- f. **CHECK**—that pressing the GRAT ILLUM MAN pushbutton causes one momentary illumination of the graticule.
- g. Set the GRAT ILLUM control to midrange (out of the PULSED detent position).

D. TRIGGER SYSTEM

Equipment Required: (Numbers correspond to those listed in Table 5-3, Test Equipment.)

- | | |
|---|--|
| 1. Test Oscilloscope | 10. Signal Standardizer |
| 2. or 3. Amplifier | 12. Coaxial Cable (one 18-inch required) |
| 4. Time-Base (two required) | 13. Coaxial Cable (two 42-inch required) |
| 9. Plug-in Extender (rigid calibration fixture) | 19. Tool, Alignment |

D1. TRIGGER SYSTEM PRELIMINARY SETUP

- Perform the Adjustment and Performance Check Power-Up Sequence.
- Refer to Section 6, Instrument Options, and the Change Information at the rear of this manual for any modifications which may affect this procedure.
- See the **TEST POINT AND ADJUSTMENT LOCATIONS D** foldout page in Section 8, Diagrams and Circuit Board Illustrations.
- Set the 7904A controls as follows:

POWER switch On
 VERTICAL MODE RIGHT
 VERT TRACE SEPARATION (B)..... Midrange
 A TRIGGER SOURCE VERT MODE
 A INTENSITY Fully counterclockwise
 HORIZONTAL MODE A
 B INTENSITY Fully counterclockwise
 B TRIGGER SOURCE VERT MODE
 FOCUS Midrange
 READOUT INTENSITY OFF (in detent)
 GRAT ILLUM Midrange
 BEAMFINDER Pushbutton out

D2. ADJUST A TRIGGER SELECTOR CENTERING (A14R255, A14R270, A14R274, A14R279)

NOTE

First perform step D1, then proceed.

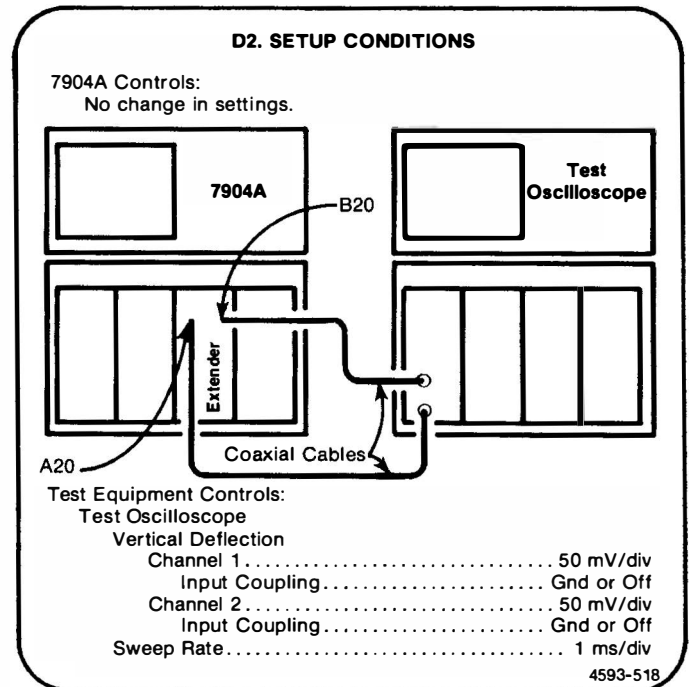

- Within the plug-in extender, disconnect the top connector on the left and right sides (labeled A20 and B20). Connect each female connector to one of the test oscilloscope channels with the 42-inch 50-ohm coaxial cables and 50-ohm bnc terminations (omit the 50-ohm bnc terminations if the test oscilloscope has a 50-ohm input impedance).
- Set the test oscilloscope for differential operation between the two channels (added display mode with one channel inverted).
- Establish a ground reference level for the test oscilloscope by positioning the trace to the center horizontal line of the graticule. Do not change the test oscilloscope Position controls after setting this ground reference.

Checks and Adjustment—7904A
Part II—Adjustment and Performance Check

- d. Set both channels of the test oscilloscope for dc input coupling.
- e. **EXAMINE**—the test oscilloscope display for a dc level within 1 division (50 millivolts) of the ground reference level in the LEFT, RIGHT, and ADD positions of the VERTICAL MODE switch.
- f. **ADJUST**—the A DC Center adjustment, R255 (on the A14 Trigger Selector Board) for a dc level within 1 division (50 millivolts) of the ground reference level in the LEFT, RIGHT, and ADD positions of the VERTICAL MODE switch.
- g. Install the signal standardizer in the 7904A LEFT VERT compartment.
- h. Set the VERTICAL MODE switch to LEFT.
- i. Set the signal standardizer Test selector to Trigger +Step Resp, and the Rep Rate to 1kHz. Use the signal standardizer Position and Amplitude controls to center a 6-division display on the test oscilloscope. Set the test oscilloscope sweep rate to 0.5 millisecond/division.
- j. **EXAMINE**—the test oscilloscope display for less than +3% and -3% aberrations.
- k. **ADJUST**—the A Thermal adjustment, R270 (on the A14 Trigger Selector Board) for optimum square wave displayed on the test oscilloscope.
- l. Set the signal standardizer Test selector to Trigger Gain and the Rep Rate to 1 MHz. Use the signal standardizer Position control to move the bright trace display on the test oscilloscope to the center graticule line.
- m. **EXAMINE**—the test oscilloscope display for nine traces with six divisions of vertical deflection between the center seven traces, within 0.6 division (300 millivolts, within 30 millivolts).
- n. **ADJUST**—the A Gain adjustment, R274 (on the A14 Trigger Selector Board) for a test oscilloscope display of six divisions of deflection between the center seven traces, within 0.6 division (300 millivolts, within 30 millivolts).
- o. Remove the signal standardizer from the LEFT VERT compartment.
- p. Set the test oscilloscope to alternate between channel 1 and channel 2. Re-establish a ground reference for both channels of the test oscilloscope. Then set both channels for dc coupling.
- q. **EXAMINE**—the test oscilloscope display for a dc level within 1 division (50 millivolts) of the established ground reference.
- r. **ADJUST**—the A DC Common Mode adjustment, R279 (on the A14 Trigger Selector Board) for a dc level within 1 division of ground.

Checks and Adjustment—7904A
Part II—Adjustment and Performance Check

D3. ADJUST B TRIGGER SELECTOR CENTERING AND GAIN (A14R455, A14R474, A14R479)

NOTE

If the preceding step was not performed, first perform step D1, then proceed.

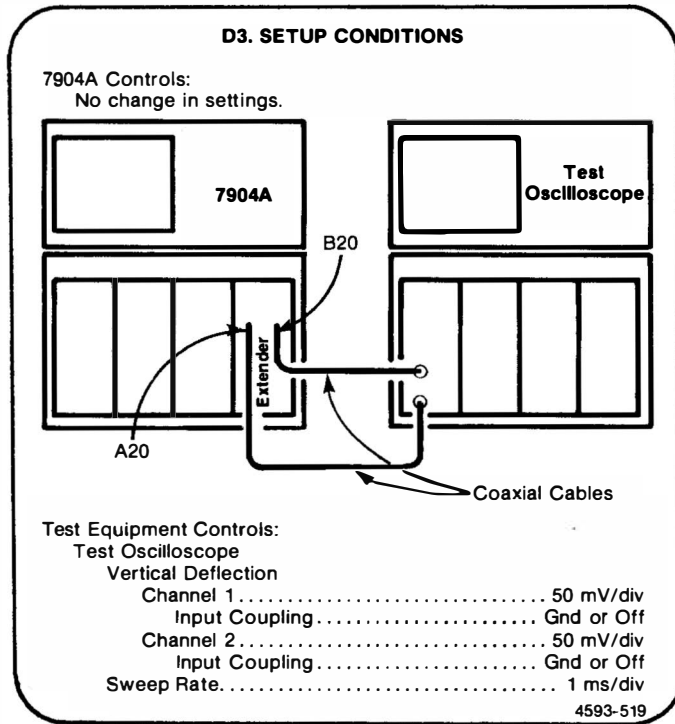

- a. Set the test oscilloscope for differential operation between the two channels (added display mode with one channel inverted).
- b. Establish a ground reference level for the test oscilloscope by positioning the trace to the center horizontal line of the graticule. Do not change the test oscilloscope Position controls after setting this ground reference.
- c. Within the plug-in extender, disconnect the top connector on the left and right sides (labeled A20 and B20). Connect each female connector to one of the test oscilloscope channels with the 42-inch 50-ohm coaxial cables and 50-ohm bnc terminations (omit the 50-ohm bnc terminations if the test oscilloscope has a 50-ohm input impedance).
- d. Set both channels of the test oscilloscope for dc input coupling.

- e. **EXAMINE**—test oscilloscope display for a dc level within 1 division (50 millivolts) of the ground reference level in the LEFT, RIGHT, and ADD positions of the 7904A VERTICAL MODE switch.
- f. **ADJUST**—B DC Center adjustment, R455 (on the A14 Trigger Selector Board) for a dc level within 1 division (50 millivolts) of the ground reference level in the LEFT, RIGHT, and ADD positions of the VERTICAL MODE switch.
- g. Install the signal standardizer in the LEFT VERT compartment.
- h. Set the VERTICAL MODE switch to LEFT.
- i. Set the signal standardizer Test Selector to Trigger Gain and the Rep Rate to 1 MHz. Use the signal standardizer Position control to align the bright trace displayed on the test oscilloscope with the center graticule line.
- j. **EXAMINE**—the test oscilloscope display for nine traces with six divisions of vertical deflection between the center seven traces, within 0.6 division (300 millivolts, within 30 millivolts).
- k. **ADJUST**—B Gain adjustment, R474 (on the A14 Trigger Selector Board) for a test oscilloscope display of six divisions of deflection between the center seven traces, within 0.6 division.
- l. Remove the signal standardizer from the LEFT VERT compartment.
- m. Set the test oscilloscope to alternate between channel 1 and channel 2. Re-establish a ground reference for both channels of the test oscilloscope. Then set both channels for dc coupling.
- n. **EXAMINE**—the test oscilloscope display for a dc level within 1 division (50 millivolts) of the established ground references (both traces).
- o. **ADJUST**—the B DC Common Mode adjustment, R479 (on the A14 Trigger Selector Board) for dc levels within 1 division of ground (both traces).
- p. **INTERACTION**—the adjustment of R479, R474, and R455 may interact. Repeat step D3 if necessary.

D4. CHECK/ADJUST VERTICAL SIGNAL OUT DC CENTERING (A14R485, A14R480, A14R490)

NOTE

If the preceding step was not performed, first perform step D1, then proceed.

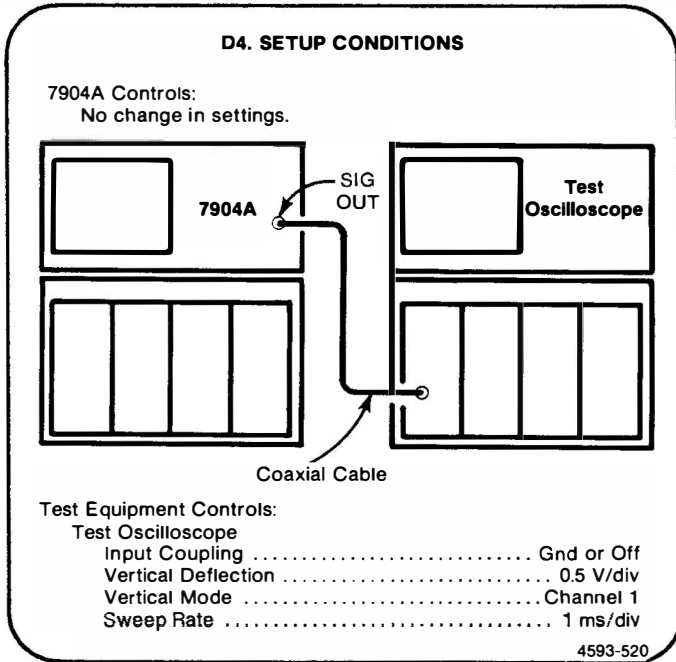

- a. Establish a ground reference for the test oscilloscope by positioning the trace to the graticule center line. Do not change the test oscilloscope Position control after setting this ground reference.
- b. Connect the front-panel SIG OUT connector to the vertical input of the test oscilloscope with the 42-inch, 50-ohm coaxial cable.

- c. Set the test oscilloscope input coupling switch to dc.
- d. **CHECK**—test oscilloscope display for a dc level within 1 division of the ground reference established in part a.
- e. **ADJUST**—Signal Out DC Center adjustment, R485 (on the A14 Trigger Selector Board) for a dc level within 1 division of the ground reference level.
- f. Install the signal standardizer in the LEFT VERT compartment.
- g. Set the Test selector to Trigger +Step Resp and the Rep Rate to 1 kHz.
- h. Rotate the signal standardizer Position and Amplitude controls to display a six-division triggered signal on the test oscilloscope.
- i. **EXAMINE**—the test oscilloscope square-wave display for optimum flat top within 0.1 division.
- j. **ADJUST**—the Signal Out Thermal 1 adjustment R480 (on the A14 Trigger Selector Board) to optimize the test oscilloscope square-wave display.
- k. Set the signal standardizer Rep Rate to 10 kHz.
- l. Set the test oscilloscope sweep rate to 50 microseconds/division.
- m. **EXAMINE**—the test oscilloscope square-wave display for a flat top, within 0.2 division.
- n. **ADJUST**—the Signal Out Thermal 2 adjustment, R490 (on the A14 Trigger Selector Board) to optimize test oscilloscope square-wave display.

Checks and Adjustment—7904A
Part II—Adjustment and Performance Check

D5. CHECK TRIGGER SELECTOR OPERATION

NOTE

If the preceding step was not performed, first perform step D1, then proceed.

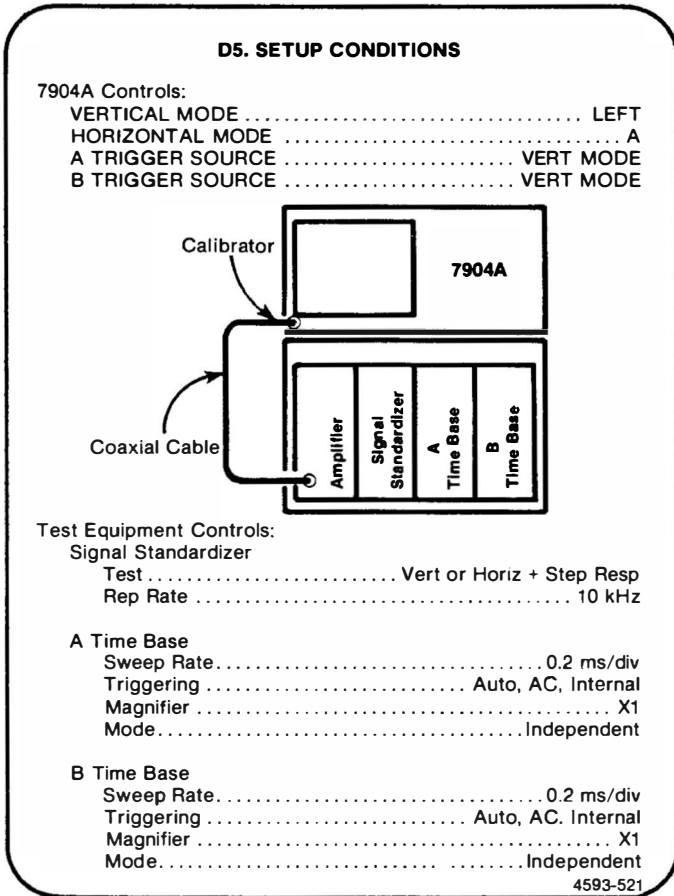

- a. Set the A INTENSITY control for a visible display. Set the amplifier for a 2-division display in the upper half of the graticule area. Use the A time-base Triggering Level control to trigger the display.
- b. Set the VERTICAL MODE switch to RIGHT.
- c. Set the signal standardizer Amplitude and Position controls for a 2 division display in the lower half of the graticule area.
- d. Set the VERTICAL MODE switch to ALT.
- e. **CHECK**—the crt display for 1 kHz and 10 kHz triggered waveforms (adjust the time-base unit Triggering Level controls as necessary).
- f. Set the VERTICAL MODE switch to ADD.
- g. **CHECK**—the crt display for a triggered waveform.
- h. Set the VERTICAL MODE switch to CHOP.
- i. **CHECK**—the crt for a stable display of the 1 kHz waveform only.
- j. Set the A TRIGGER SOURCE switch to LEFT VERT.
- k. **CHECK**—sequentially select all positions of the VERTICAL MODE switch and check for a stable display of only the 1 kHz waveform.
- l. Set the A TRIGGER SOURCE switch to RIGHT VERT.
- m. **CHECK**—sequentially select all positions of the VERTICAL MODE switch and check for a stable display of only the 10 kHz waveform.
- n. Set the VERTICAL MODE switch to ALT, the HORIZONTAL MODE switch to B, and the B INTENSITY control for a visible display.
- o. **CHECK**—the crt display for 1 kHz and 10 kHz triggered waveforms.
- p. Set the VERTICAL MODE switch to ADD.
- q. **CHECK**—crt for a stable display.
- r. Set the VERTICAL MODE switch to CHOP.
- s. **CHECK**—crt for a stable display of only the 1 kHz waveform.
- t. Set the B TRIGGER SOURCE switch to LEFT VERT.
- u. **CHECK**—sequentially select all positions of the VERTICAL MODE switch and check for a stable display of only the 1 kHz waveform.
- v. Set the B TRIGGER SOURCE switch to RIGHT VERT.
- w. **CHECK**—sequentially select all positions of the VERTICAL MODE switch and check for a stable display of only the 10 kHz waveform.
- x. Set the VERTICAL MODE switch to ALT, the HORIZONTAL MODE switch to ALT, and the A and B TRIGGER SOURCE switches to VERT MODE.
- y. **CHECK**—that the B HORIZ time-base is triggered on the 1 kHz waveform and the A HORIZ time-base is triggered on the 10 kHz waveform (set the time base Triggering Level controls for triggered sweeps).

E. HORIZONTAL SYSTEM

Equipment Required: (Numbers correspond to those listed in Table 5-3, Test Equipment.)

- | | |
|--------------------------------------|-----------------------------|
| 2, 3. Amplifier (two required) | 12. Coaxial Cable (18-inch) |
| 4. Time Base | 13. Coaxial Cable (42-inch) |
| 6. Low-Frequency Sine-Wave Generator | 15. Adapter, BNC T |
| 10. Signal Standardizer | 17. Screwdriver, Slotted |
| 11. Time-Mark Generator | |

E1. HORIZONTAL SYSTEM PRELIMINARY SETUP

- Perform the Adjustment and Performance Check Power-Up Sequence.
- Refer to Section 6, Instrument Options, and the Change Information at the rear of this manual for any modifications which may affect this procedure.
- See the **TEST POINT AND ADJUSTMENT LOCATIONS E** foldout page in Section 8, Diagrams and Circuit Board Illustrations.
- Set the 7904A controls as follows:

POWER switch On
 VERTICAL MODE RIGHT
 VERT TRACE SEPARATION (B) Midrange
 A TRIGGER SOURCE VERT MODE
 A INTENSITY Midrange
 HORIZONTAL MODE A
 B INTENSITY Midrange
 B TRIGGER SOURCE VERT MODE
 READOUT INTENSITY OFF (in detent)
 GRAT ILLUM As desired
 CONTROL ILLUM MEDIUM (rear panel)
 CALIBRATOR 0.4 V

E2. ADJUST HORIZONTAL AMPLIFIER LIMIT CENTERING (A28R630)

NOTE

First perform step E1, then proceed.

E2. SETUP CONDITIONS

7904A Controls:
No change in settings.

Test Equipment Controls:

Time Base
 Triggering Auto, AC, Internal
 Sweep Rate 5 μ s/div

Signal Standardizer
 Test Vert or Horiz Com Mode

4593-528

- Short TP610 to TP750 (on the A28 Horizontal Amplifier board) with a 12-inch jumper wire.
- EXAMINE**—the vertical trace; it should be within 0.5 division of the center vertical graticule line.
- ADJUST**—Limit CTR adjustment, R630 (on the A28 Horizontal Amplifier Board) to align the displayed trace with the center vertical graticule line.
- Remove the jumper wire from TP610 and TP750.

Checks and Adjustment—7904A
Part II—Adjustment and Performance Check

E3. ADJUST HORIZONTAL AMPLIFIER CENTERING (A28R121)

NOTE

If the preceding step was not performed, first perform step E1, then proceed.

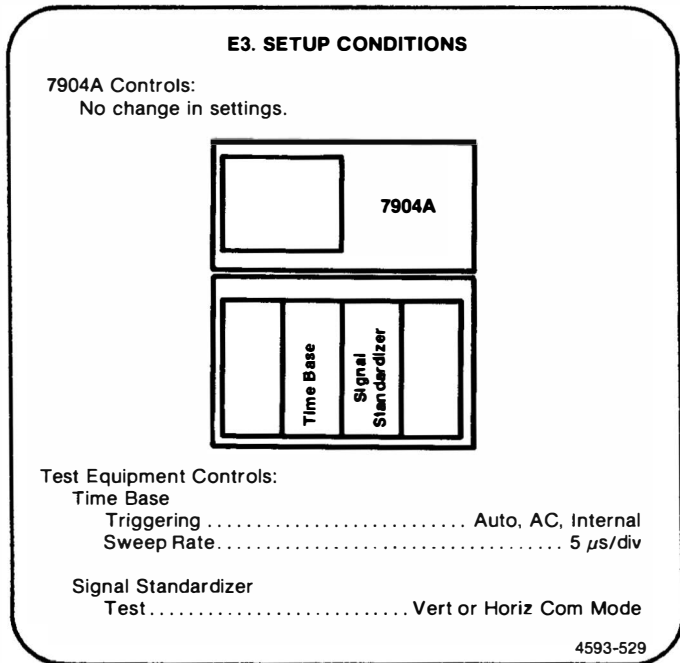

- a. **EXAMINE**—the vertical trace; it should be within 0.5 division of the center vertical graticule line.
- b. **ADJUST**—CTR adjustment, R121 (on the A28 Horizontal Amplifier Control Board) to align the displayed trace with the center vertical graticule line.
- c. Move the signal standardizer to the B HORIZ compartment and change the HORIZONTAL MODE switch to B.
- d. **EXAMINE**—the vertical trace; it should be within 0.5 division of the center vertical graticule line.
- e. **ADJUST**—if necessary, compromise the setting of R121 for optimum centering for both horizontal compartments. If readjustment is necessary, repeat parts a, b, c, and d of this step.

E4. CHECK/ADJUST HORIZONTAL GAIN AND LOW FREQUENCY LINEARITY (A28R230)

NOTE

If the preceding step was not performed, first perform step E1, then proceed.

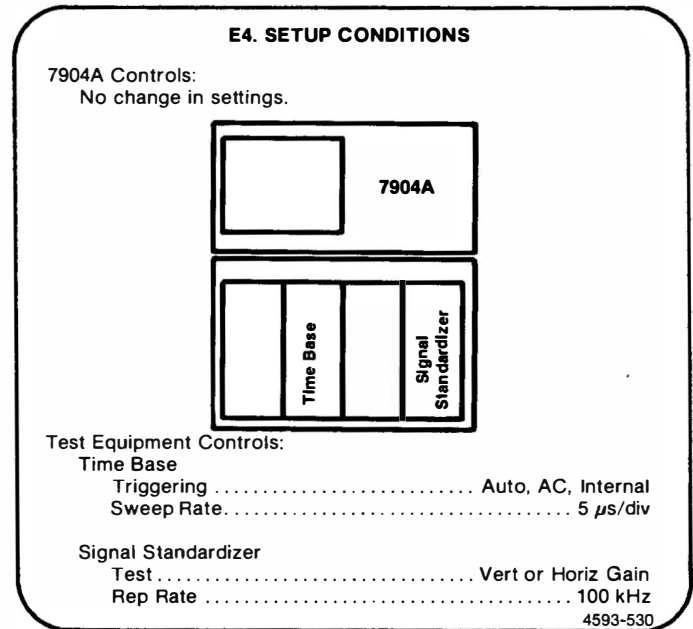

- a. Align the bright vertical trace with the center vertical graticule line (use the signal standardizer Position control).
- b. **CHECK**—that the second and tenth vertical traces align with the second and tenth graticule lines within 0.08 division.
- c. **ADJUST**—Gain adjustment, R230 (on the A28 Horizontal Amplifier Board) for eight divisions of deflection between the second and tenth graticule lines.
- d. **CHECK**—along the horizontal graticule line for 0.05 division or less error at each vertical graticule line intersection.
- e. Move the signal standardizer to the A HORIZ compartment and change the HORIZONTAL MODE switch to A.
- f. **CHECK**—that the deflection between the second and tenth graticule lines is the same as in part d of this step, within 0.08 division.
- g. **ADJUST**—if necessary compromise the setting of R230 (on the A28 Horizontal Amplifier Board) for optimum gain in both horizontal compartments. If readjustment is necessary repeat parts a, b, c, and d of this step.

E5. ADJUST READOUT CENTERING AND GAIN (A28R114, A28R101)

NOTE

If the preceding step was not performed, first perform step E1, then proceed.

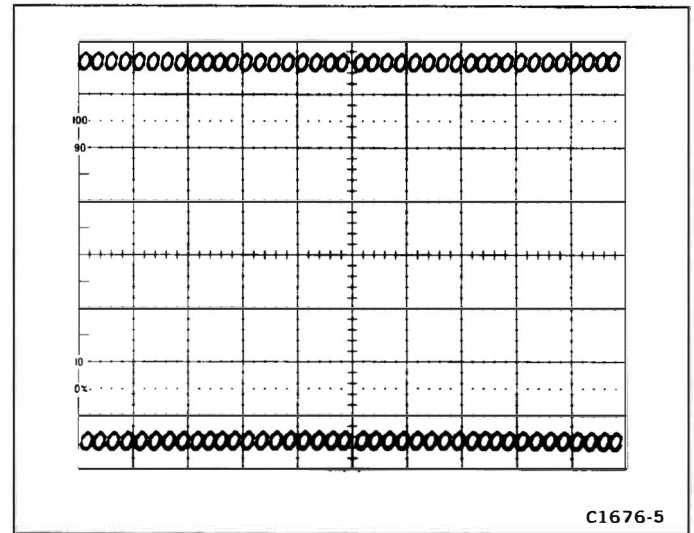
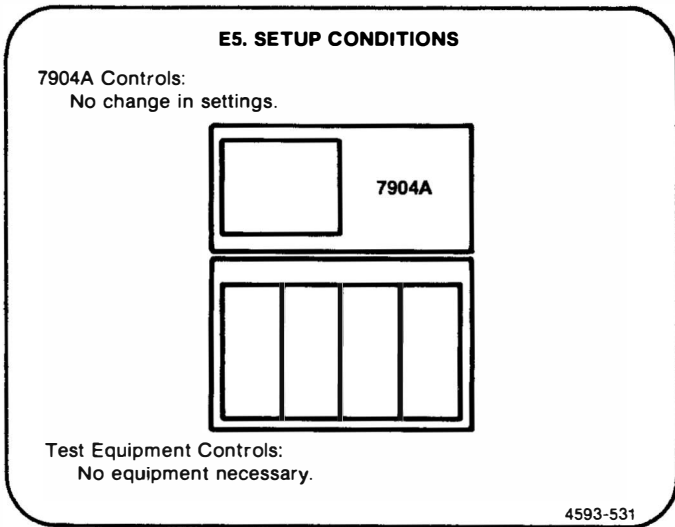

Figure 5-2. Readout display with Q2225 removed.

- a. Set the 7904A POWER switch to OFF.
- b. Remove Q2225 from its socket on the A15 Readout Systems Board (see Test Point and Adjustment Locations G).
- c. Set the 7904A POWER switch to ON and adjust the READOUT INTENSITY control for visible characters (all zeros).
- d. **EXAMINE**—the crt display for two rows of zeros centered horizontally within the graticule area. See Figure 5-2.
- e. **ADJUST**—RO CENTER adjustment, R114 (on the A28 Horizontal Amplifier Board) to horizontally center the readout display within the limits of the graticule area.
- f. **ADJUST**—RO Gain adjustment, R101 (on the A28 Horizontal Amplifier Board) so that all characters are displayed within the limits of the graticule area.
- g. Set the 7904A POWER switch to OFF, and replace Q2225 in its socket.

Checks and Adjustment—7904A
Part II—Adjustment and Performance Check

E6. CHECK/ADJUST HIGH-FREQUENCY TIMING (A28C810, A28C850, A28C310, A28C340, A28R312, A28R340, A28C922)

NOTE

If the preceding step was not performed, first perform step E1, then proceed.

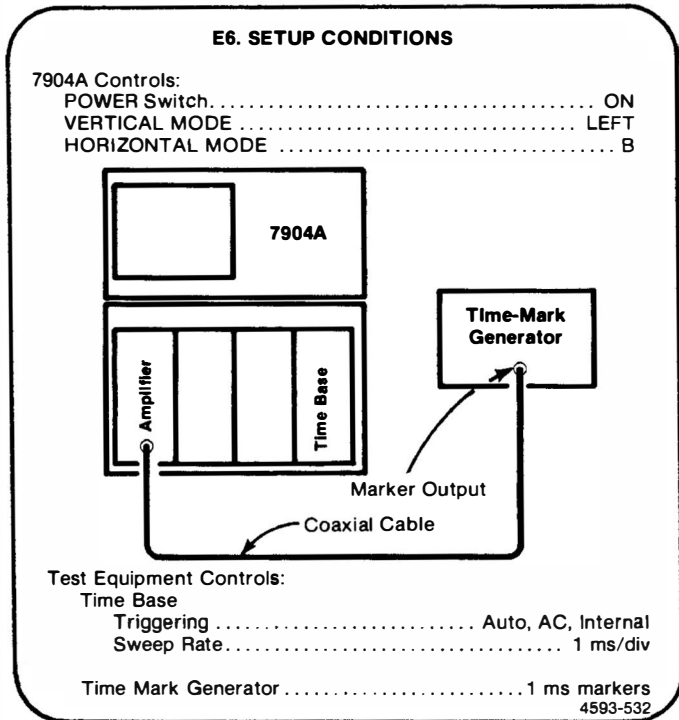

- a. Set the amplifier deflection factor for approximately two divisions of display (set the time-base Triggering Level as necessary for a stable display).
- b. **EXAMINE**—crt display for one time-marker per division over the center eight divisions.
- c. **ADJUST**—time-base unit front-panel Swp Cal adjustment for one time-marker per division over the center eight divisions.
- d. **CHECK**—refer to the Performance Check procedures in the time-base unit instruction/service manual to check high-frequency timing and accuracy to 0.5 ns (500 ps is the fastest calibrated sweep rate for the 7904A). If the given limits are met, omit the remainder of this step.
- e. Set the time-base Time/Div to 2 ns. Set the time-mark generator for a 2 ns sine-wave timing signal.
- f. **EXAMINE**—sine-wave display alignment of the second and tenth sine-wave peaks at the second and tenth graticule line.

- g. **ADJUST**—high-frequency timing adjustments, C810 and C850 (on the A28 Horizontal Amplifier Board) for alignment of the second and tenth sine-wave peaks with the second and tenth graticule lines.

NOTE

It is important that the adjustment of C810 and C850 be balanced. Therefore each capacitor should be adjusted equally.

- h. Set the time-base Time/Div to 5 ns and the Mag control to X10 (time-base sweep rate of 0.5 nanoseconds/division).
- i. Set the time-mark generator for 1 ns sine-wave timing signals. Set the amplifier deflection factor for approximately four divisions of amplitude.
- j. **EXAMINE**—the sine wave display for four cycles over the center eight divisions (sine wave peaks at the second and tenth graticule lines).
- k. **ADJUST**—HF Timing adjustments, C310 and C340 (on the A28 Horizontal Board) for four cycles of sine wave signal over the center eight graticule divisions.

NOTE

It is important that the adjustment of C310 and C340 be balanced. Therefore each capacitor should be adjusted equally.

- l. **EXAMINE**—crt display for one sine-wave cycle for each two graticule divisions over the center eight divisions of display.
- m. **ADJUST**—HF Linearity adjustments, R312 and R340 (on the A28 Horizontal Amplifier Board) for one sine-wave cycle per each two graticule divisions over the center eight graticule divisions.

NOTE

It is important that the adjustment of R312 and R340 be balanced. Therefore each resistor should be adjusted equally.

- n. Set the time-base Time/Div to 10 ns/division and the Mag to X10 (time-base unit sweep rate of 1 nanosecond/division).
- o. **EXAMINE**—sine-wave display for one cycle per graticule line over the center eight graticule divisions.

- p. **ADJUST**—1 ns linearity adjustment, C922 (on the A28 Horizontal Amplifier Board) for 1 cycle per each graticule division over the center eight divisions of display.
- q. **CHECK**—repeat the horizontal timing checks as outlined in part d.
- r. **INTERACTION**—if the timing parameters in part d are not met, repeat parts e through q of this step.

E7. ADJUST HORIZONTAL READOUT JITTER (A28R240)

NOTE

If the preceding step was not performed, first perform step E1, then proceed.

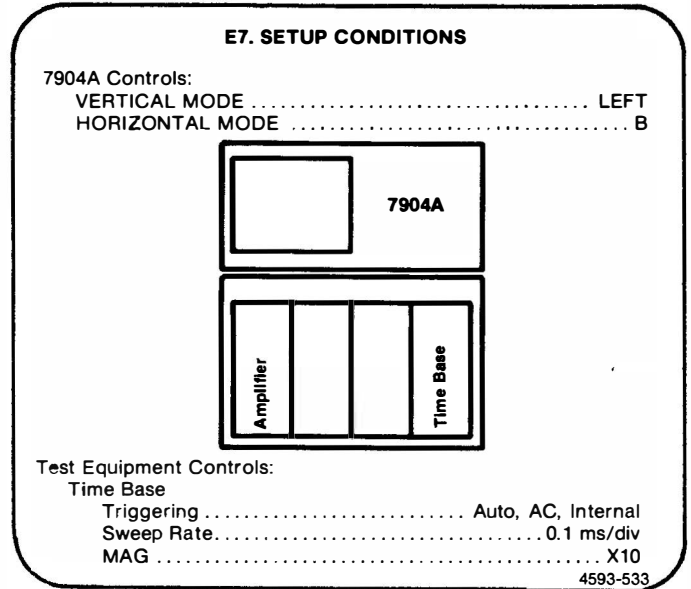

- a. Set the READOUT INTENSITY for a visible readout display.
- b. **EXAMINE**—crt readout display for minimum readout jitter.
- c. **ADJUST**—LF Comp adjustment, R240 (on the A28 Horizontal Amplifier Board) for minimum readout jitter.

Checks and Adjustment—7904A
Part II—Adjustment and Performance Check

E8. CHECK/ADJUST X-Y DELAY COMPENSATION (A17C804, A17C814)

NOTE

If the preceding step was not performed, first perform step E1, then proceed.

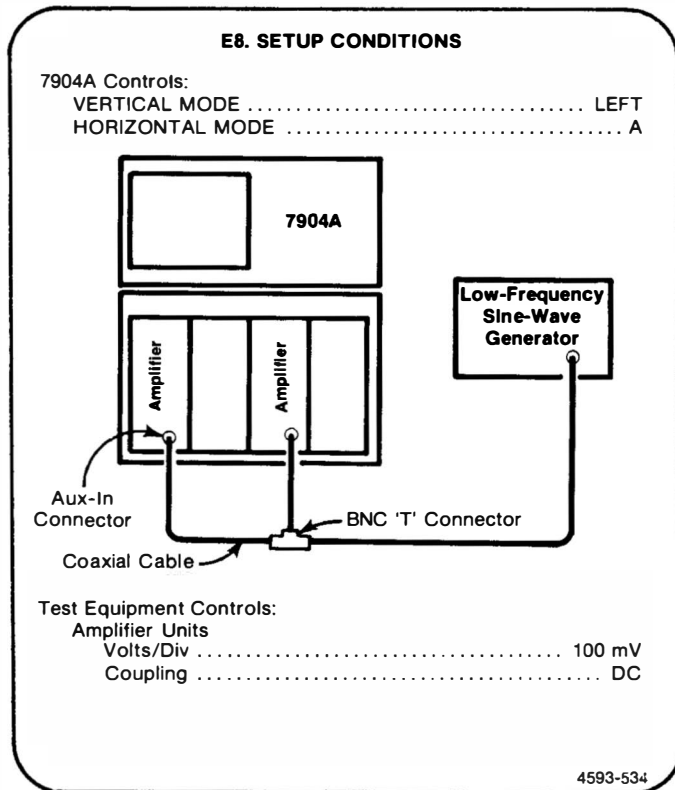

- e. Set both Internal Delay Disable switches, S801 and S811, (on the A17 X-Y Delay Compensation Board) to the In (up) position.
- f. Set the low-frequency sine-wave generator to produce eight divisions of vertical and horizontal deflection at 1 MHz.
- g. **CHECK**—the crt display for a Lissajous pattern with a separation of 0.28 division or less (indicates 2° or less phase shift; see Figure 5-3).
- h. **ADJUST**—X-Y Comp adjustment, C814 (on the A17 X-Y Delay Compensation Board) for minimum separation of the display (see Figure 5-3).
- i. Remove the amplifier from the B HORIZ compartment and install it in the A HORIZ compartment (leave signal connected).
- j. Set the HORIZONTAL MODE to A.
- k. **CHECK**—the crt display for a Lissajous pattern with a separation of 0.28 division or less (indicates 2° or less phase shift; see Figure 5-3).
- l. **ADJUST**—X-Y Comp adjustment, C804 (on the A17 X-Y Delay Compensation Board) for minimum separation of display (see Figure 5-3).
- m. Set both Internal Delay Disable switches (S801 and S811) to the out (down) position.

- a. Set the low-frequency sine-wave generator for eight divisions of vertical and horizontal deflection at 35 kHz. Set the Amplifier unit controls to match the vertical and horizontal deflection.
- b. **CHECK**—crt display for a Lissajous display with separation of 0.28 division or less (indicates 2° or less phase shift; see Figure 5-3).
- c. Remove the amplifier unit from the A HORIZ compartment and install it in the B HORIZ compartment (leave signal connected). Set the HORIZONTAL MODE to B.
- d. Repeat part b of this step.

NOTE

Option 2 adds an X-Y Compensation network to equalize the signal delay between the vertical and horizontal deflection systems. If the instrument under test does not contain Option 2, omit the remainder of this step.

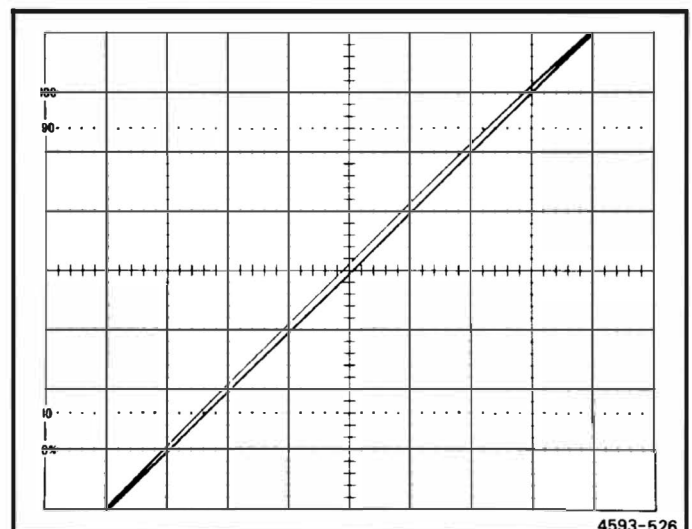

Figure 5-3. Typical display when checking X-Y phase compensation.

F. VERTICAL SYSTEM

Equipment Required: (Numbers correspond to those listed in Table 5-3, Test Equipment.)

- | | |
|---|----------------------------|
| 3. Amplifier | 13. Coaxial Cable |
| 4. Time Base (two required) | 14. Attenuator (2X) |
| 7. Medium-Frequency Sine-Wave Generator | 17. Screwdriver, Slotted |
| 8. High-Frequency Sine-Wave Generator | 18. Tool, Alignment, Nylon |
| 10. Signal Standardizer | 19. Tool, Alignment |

F1. VERTICAL SYSTEM PRELIMINARY SETUP

- Perform the Adjustment and Performance Check Power-Up Sequence.
- Refer to Section 6, Instrument Options, and the Change Information at the rear of this manual for any modifications which may affect this procedure.
- See the **TEST POINT AND ADJUSTMENT LOCATIONS F** foldout page in Section 8, Diagrams and Circuit Board Illustrations.
- Set the 7904A controls as follows:

POWER switch On
 VERTICAL MODE RIGHT
 VERT TRACE SEPARATION (B) Midrange
 A TRIGGER SOURCE VERT MODE
 A INTENSITY Midrange
 HORIZONTAL MODE A
 B INTENSITY Midrange
 B TRIGGER SOURCE VERT MODE
 FOCUS Midrange
 READOUT OFF (in detent)
 GRAT ILLUM As desired
 BEAMFINDER Pushbutton out

F2. ADJUST VERTICAL AMPLIFIER CENTERING (A18R736, A16R535)

NOTE

First perform step F1, then proceed.

F2. SETUP CONDITIONS

7904A Controls:
 VERTICAL MODE ALT

Test Equipment Controls:
 Time Base
 Sweep Rate 1 ms/div
 Triggering Auto, AC, Internal

4593-535

- Set the A INTENSITY control as desired.
- EXAMINE**—the vertical position of the alternating traces (might appear as a single trace); they should be within 0.5 division of the graticule center line.
- Set the VERTICAL MODE switch to LEFT.
- ADJUST**—MVA Center adjustment, R736 (on the A18 Vertical Amplifier Board) to align the trace with the center graticule line.
- Set the VERTICAL MODE switch to RIGHT.
- ADJUST**—Right Ctr adjustment, R535 (on the A16 Vertical Channel Switch Board) to align the trace with the center graticule line.

Checks and Adjustment—7904A
Part II—Adjustment and Performance Check

F3. CHECK/ADJUST VERTICAL AMPLIFIER GAIN (A18R211)

NOTE

If the preceding step was not performed, first perform step F1, then proceed.

F3. SETUP CONDITIONS

7904A Controls:
 No change in settings.

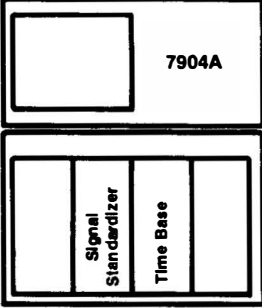

Test Equipment Controls:
 Time Base
 Sweep Rate 1 ms/div
 Triggering Auto, AC, External

Signal Standardizer
 Test Vert or Horiz Gain
 Rep Rate 100 kHz

4593-536

- a. Position the signal standardizer display to align the bright center trace with the graticule center line.
- b. **CHECK**—for one trace per graticule division within 0.05 division over the center six graticule divisions. Note the exact error for comparison in part f.
- c. **ADJUST**—Vert Gain adjustment, R211 (on the A18 Vertical Amplifier Board) for one division between each of the center seven displayed traces, within 0.05 division.
- d. Remove the signal standardizer from the RIGHT VERT compartment and install it in the LEFT VERT compartment.
- e. Set the VERTICAL MODE switch to LEFT.
- f. **CHECK**—for one trace per graticule division within 0.05 division of the error noted in part b, over the center 6 graticule divisions.
- g. **ADJUST**—if necessary, Vert Gain adjustment, R211, for the best compromise for gain in both LEFT and RIGHT compartments.

F4. CHECK VERTICAL LOW-FREQUENCY LINEARITY

NOTE

If the preceding step was not performed, first perform step F1, then proceed.

F4. SETUP CONDITIONS

7904A Controls:
 VERTICAL MODE RIGHT

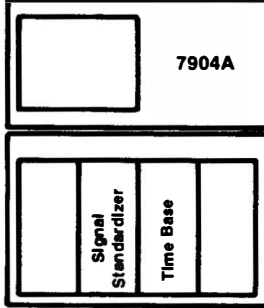

Test Equipment Controls:
 Time Base
 Sweep Rate 1 ms/div
 Triggering Auto, AC, Internal

Signal Standardizer
 Test Vert or Horiz + Step Resp
 Rep Rate 1 kHz

4593-537

- a. Set the signal standardizer Amplitude and Position controls so the display is exactly two divisions in amplitude so the display is exactly two divisions in amplitude in the center of the graticule area.
- b. **CHECK**—position the two-division display vertically and check for not more than 0.1 division of compression or expansion anywhere within the graticule area.
- c. **INTERACTION**—if the specification of part b was not met, perform steps F2, F3, F5, and F6.

F5. ADJUST THERMAL COMPENSATIONS
(A18R130, A18C200, A18R238, A18R335,
A18R237, A18R132, A18R131)

NOTE

If the preceding step was not performed, first perform step F1, then proceed.

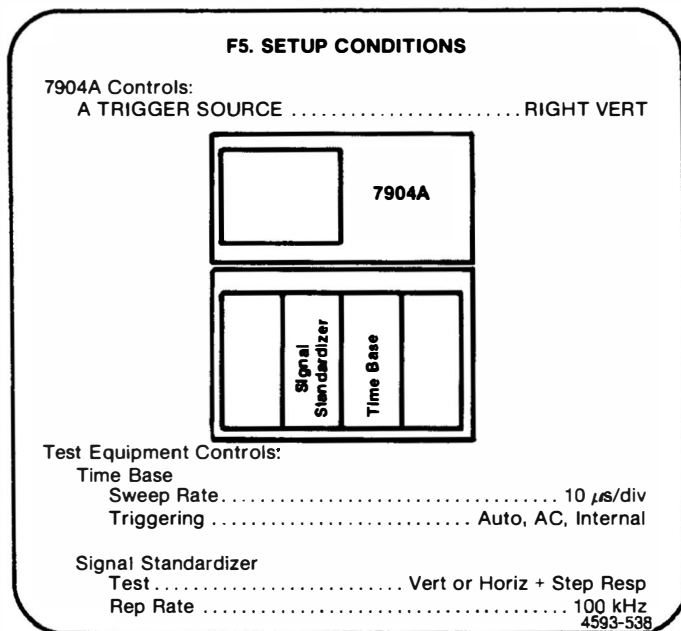

- a. Set the signal standardizer Position and Amplitude controls for an eight-division display centered on the crt.
- b. Set the VERTICAL MODE switch to CHOP.
- c. Set the READOUT INTENSITY control for a visible readout display.

TABLE 5-5
Thermal Compensation Adjustments

| Adjustment | Signal Standardizer Rep Rate | Sweep Rate |
|-----------------------------|------------------------------|------------|
| Comp (R130), Comp (C200) | 1 MHz | 1 μ s |
| Comp (R238) | 100 kHz | 10 μ s |
| Comp (R335) | 10 kHz | 0.1 ms |
| Comp (R237) | 1 kHz | 1 ms |
| Comp (R132) | 100 kHz | 10 ms |
| Comp (R131) | 10 Hz | 50 ms |

- d. **EXAMINE**—readout display for less than 0.05 divisions of jitter and 0.05 divisions of deviation in the center displayed trace using the time-base sweep rates and signal standardizer repetition rates given in Table 5-5.
- e. **ADJUST**—Thermal Compensations adjustments (on the A18 Vertical Amplifier Board) as given in Table 5-5 for minimum readout display jitter and minimum deviation of the displayed center trace.
- f. **INTERACTION**—the adjustments listed in Table 5-5 may interact with step F3, F4, F5, and F6; repeat as necessary.

Checks and Adjustment—7904A
Part II—Adjustment and Performance Check

F6. ADJUST CHANNEL SWITCH COMPENSATION
(A16C538, A16R530, A16R525, A16R520,
A16R515, A16R512, A16C638, A16R630,
A16R625, A16R620, A16R615, A16R612)

NOTE

If the preceding step was not performed, first perform step F1, then proceed.

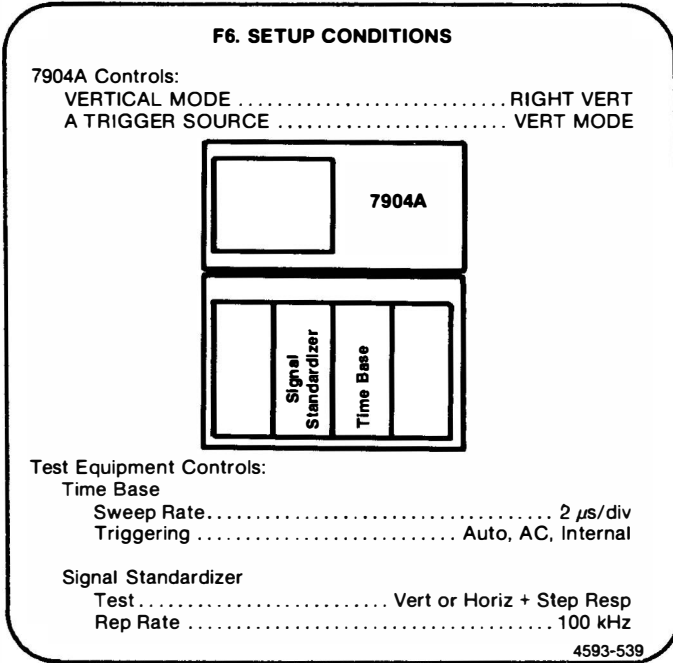

TABLE 5-6A
Right Channel-Switch Compensation
(Signal Rep Rate vs: Sweep Rate)

| Adjustment | Signal Standardizer Rep Rate | Sweep Rate |
|------------|------------------------------|--------------|
| C538,R530 | 100 kHz | 2.0 μ s |
| R525 | 10 kHz | 20.0 μ s |
| R520 | 1 kHz | 0.2 ms |
| R515 | 100 Hz | 2.0 ms |
| R512 | 10 Hz | 20.0 ms |

TABLE 5-6B
Left Channel-Switch Compensation
(Signal Rep Rate vs: Sweep Rate)

| Adjustment | Signal Standardizer Rep Rate | Sweep Rate |
|------------|------------------------------|-------------|
| C638, R630 | 100 kHz | 2.0 μ s |
| R625 | 10 kHz | 20 μ s |
| R620 | 1 kHz | 0.2 ms |
| R615 | 100 Hz | 2.0 ms |
| R612 | 10 Hz | 20.0 ms |

- a. Set the signal standardizer Amplitude control for a six-division display.
- b. Set the time-base Triggering and Position controls for a stable display.
- c. **EXAMINE**—displayed pulse for optimum flat top, within 0.06 division, with the signal standardizer Rep Rate and time-base sweep rates given in Table 5-6A.
- d. **ADJUST**—compensation adjustments (on the A16 Vertical Channel Switch Board) as given in Table 5-6A for optimum flat top on the displayed waveform.
- e. Move the signal standardizer to the LEFT VERT compartment.
- f. Set the VERTICAL MODE switch to LEFT VERT.
- g. Set the signal standardizer Rep Rate to 100 kHz and the time-base unit sweep rate to 2 μ s/division. Set the Amplitude and Position controls for a six-division display, centered on the graticule area.
- h. **EXAMINE**—displayed pulse for optimum flat top, within 0.06 division, with the signal standardizer Rep Rate and the time-base unit sweep rates given in Table 5-6B.
- i. **ADJUST**—compensation adjustments (on the A16 Vertical Channel Switch Board) as given in Table 5-6B for optimum flat top on the displayed waveform.

F7. ADJUST HIGH-FREQUENCY COMPENSATION
(A18R404, A18R405, A18C401, R83,
A18R215, A18C215, A18L100)

NOTE

If the preceding step was not performed, first perform step F1, then proceed.

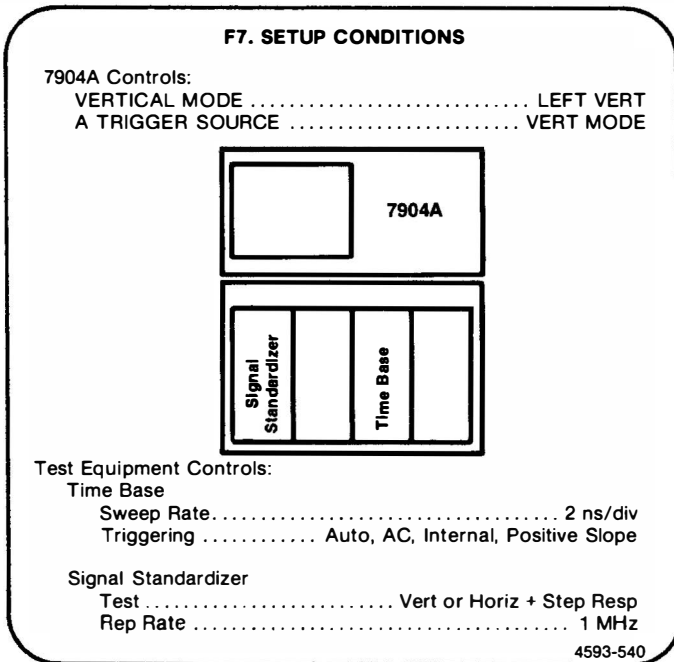

TABLE 5-7
High-Frequency Compensation Adjustment

| Adjustment | Pulse Time Segment (From 50% point of step) | Adjust For (See Part b for detailed adjustment limits) |
|---------------------------|--|---|
| A18R404, A18R405, A18C401 | First 5 ns. | Optimum rise time and flat top with aberrations not to exceed 0.3 div p-p. |
| R83 (on 7904A chassis) | First 7 ns (Time-base unit sweep rate at 10 ns/div). | Minimum slope. R83 INTERACTS with Vert Gain adjustment A18R211. |
| A18R215, A18C215 | | Best front corner and minimum aberrations. Adjust rise time for 600 ps or less. |
| A18L100 | From 2 ns to 5 ns. | Best flat top. |

- a. Set the signal standardizer Amplitude and Position controls for a six-division display centered on the crt. Set the time-base unit Position control to align the 50% point of the step with the second vertical graticule line.
- b. **EXAMINE**—the transient response for optimum square corner and flat top on the displayed pulse within the following limits: Aberrations in the first 5 nanoseconds after the 50% point of the step should not exceed 0.3 division peak-to-peak. Aberrations from 5 to 10 nanoseconds after the 50% point of the step should not exceed 0.18 division peak-to-peak. Aberrations after 10 nanoseconds of the 50% point of the step should not exceed 0.06 division peak-to-peak except to allow 0.12 division of aberrations for delay-line termination at about 130 nanoseconds from the step (change time/division setting as necessary to view 130 nanoseconds from step). Rise time of the pulse should be 600 picoseconds between the 10% and 90% points.
- c. **ADJUST**—High Frequency compensation as given in Table 5-7. (The High Frequency Compensation adjustments are located on the A18 Vertical Amplifier Board.)
- d. **INTERACTION**—adjustments in step F7 interact with steps F3, F4, and F5; repeat as necessary.
- e. Move the signal standardizer to the RIGHT VERT compartment and set the VERTICAL MODE switch to RIGHT.
- f. **EXAMINE**—displayed pulse for optimum square corner and flat top with aberrations within the limits given in part b.
- g. **INTERACTION**—if necessary, compromise the High-Frequency Compensation Adjustments given in Table 5-7.

Checks and Adjustment—7904A
Part II—Adjustment and Performance Check

F8. CHECK VERTICAL AMPLIFIER
500 MHz GAIN

NOTE

If the preceding step was not performed, first perform step F1, then proceed.

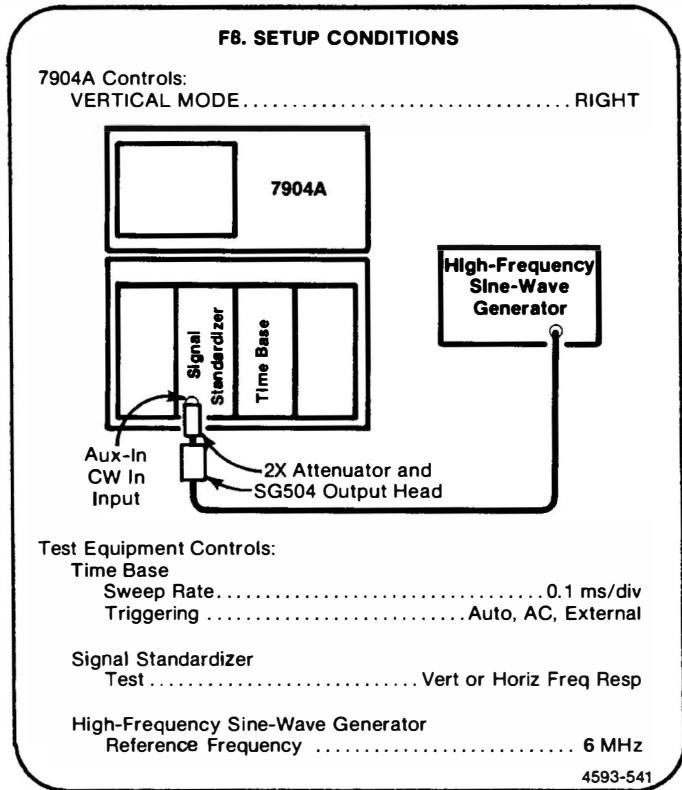

- c. Set the signal standardizer Amplitude control for a six-division display, centered on the graticule. (The CW Leveled indicator should be lit.)
- d. Without changing the output amplitude, increase the generator frequency until the displayed amplitude is reduced to 4.6 divisions. If the CW Leveled indicator extinguishes, increase the amplitude of the sine-wave generator signal until the light just turns on.

NOTE

The signal standardizer CW Leveled light must be on and the sine-wave generator must be properly connected for a valid check. Refer to the signal standardizer and high-frequency sine-wave generator manuals.

- e. **CHECK**—sine-wave generator frequency is 500 MHz or higher (verifies 500 megahertz gain).
- f. Move the signal standardizer to the LEFT VERT compartment (leave signal connected) and set the VERTICAL MODE switch to LEFT.
- g. **CHECK**—repeat parts d. through f. for the LEFT VERT compartment.
- h. **INTERACTION**—if the specifications of steps e or g were not met, perform steps F2, F3, F4, F6, and F8.

- a. Set the signal standardizer Amplitude control fully clockwise.
- b. Set the high-frequency sine-wave generator for a 10-division display at the reference frequency (between 6 and 50 megahertz) centered on the graticule. (To obtain a 10-division display, first obtain an eight-division display, then vertically position the display one division down and increase the output amplitude of the sine-wave generator so that the top of the display reaches the top of the graticule.)

F9. CHECK VERTICAL CHANNEL ISOLATION

NOTE

If the preceding step was not performed, first perform step F1, then proceed.

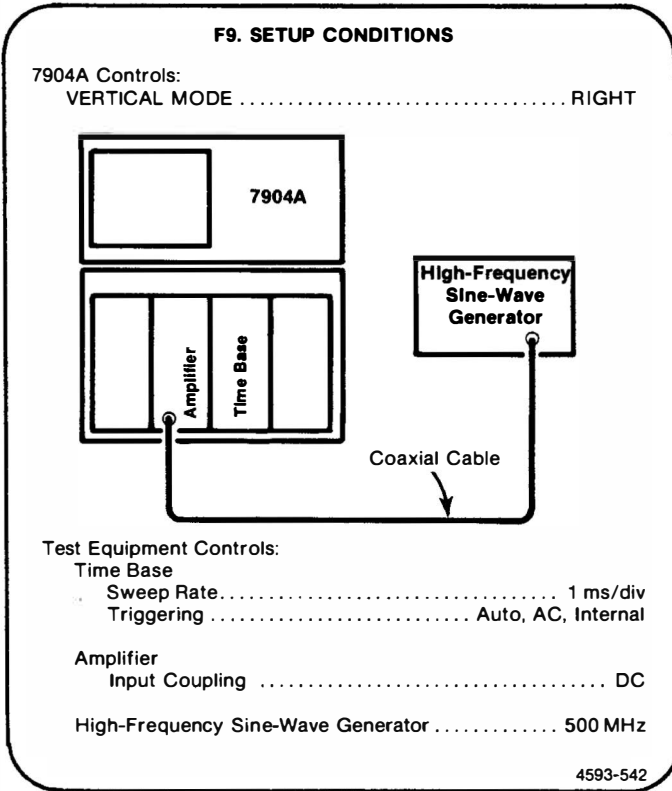

- a. Connect the output of the high-frequency sine-wave generator to the amplifier input.
- b. Set the output of the high-frequency sine-wave generator and the amplifier deflection factor for eight-divisions of deflection at 500 MHz.
- c. Set the VERTICAL MODE switch to LEFT.
- d. **CHECK**—crt display amplitude for 0.1 division or less of the 500 MHz signal (verifies isolation of at least 80:1 at 500 MHz).
- e. Move the amplifier unit to the LEFT VERT compartment without changing any settings.
- f. Set the VERTICAL MODE switch to RIGHT.
- g. **CHECK**—crt display amplitude for 0.1 division or less of the 500 MHz signal (verifies isolation of at least 80:1 at 500 MHz). Disconnect the high-frequency sine-wave generator.
- h. Set the VERTICAL MODE switch to LEFT.
- i. Connect the medium-frequency sine-wave generator to the amplifier input.
- j. Set the medium-frequency sine-wave generator for eight divisions of deflection at 100 megahertz.
- k. Set the VERTICAL MODE switch to RIGHT.
- l. **CHECK**—crt display amplitude for 0.05 division or less of 100 megahertz signal (verifies 100 megahertz isolation of at least 160:1).
- m. Move the amplifier to the RIGHT VERT compartment without changing any settings.
- n. Set the VERTICAL MODE switch to LEFT.
- o. **CHECK**—crt display amplitude for 0.05 division or less of 100 megahertz signal (verifies isolation of at least 160:1 from dc to 100 megahertz).

Checks and Adjustment—7904A
Part II—Adjustment and Performance Check

F10. CHECK VERTICAL DISPLAY MODES

NOTE

If the preceding step was not performed, first perform step F1, then proceed.

F10. SETUP CONDITIONS

7904A Controls:
 VERTICAL MODE RIGHT

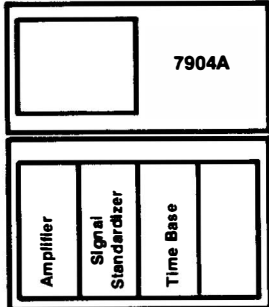

Test Equipment Controls:
 Time Base
 Sweep Rate 1 ms/div
 Triggering Auto, AC, Internal

Amplifier
 Deflection Factor 0.1 V/div
 Input Coupling DC

Signal Standardizer
 Test Vert or Horiz Aux In

4593-543

- a. Position the trace to the upper half of the graticule area with the signal standardizer Position control.
- b. Set the VERTICAL MODE switch to LEFT and position the trace to the lower half of the graticule area with the amplifier Position control.
- c. **CHECK**—for two traces in the ALT and CHOP positions of the VERTICAL MODE switch.
- d. Set the VERTICAL MODE switch to ADD.
- e. **CHECK**—for a single trace that can be positioned vertically with either left or right vertical Position controls.

F11. CHECK VERTICAL TRACE SEPARATION (B) OPERATION

NOTE

If the preceding step was not performed, first perform step F1, then proceed.

F11. SETUP CONDITIONS

7904A Controls:
 HORIZONTAL MODE CHOP
 VERTICAL MODE ADD

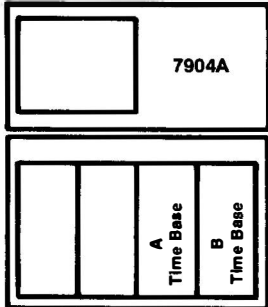

Test Equipment Controls:
 A Time Base
 Sweep Rate 1 ms/div
 Triggering Auto, AC, Internal

B Time Base
 Sweep Rate 1 ms/div
 Triggering Auto, AC, Internal

4593-544

- a. **CHECK**—rotate the VERT TRACE SEPARATION (B) control throughout its range and check that the trace produced by the B time-base unit can be positioned above and below the trace produced by the A time-base unit by at least 3.5 divisions. Repeat with the HORIZONTAL MODE switch set to ALT.

G. READOUT SYSTEM SN B031766 & Below

Equipment Required: (Numbers correspond to those listed in Table 5-3, Test Equipment.)

- | | |
|----------------------------|--------------------------|
| 2. Amplifier, Dual-Channel | 17. Screwdriver, slotted |
| 4. Time Base | 19. Tool, Alignment |

G1. READOUT SYSTEM PRELIMINARY SETUP

- a. Perform the Adjustment and Performance Check Power-Up Sequence.
- b. Refer to Section 6, Instrument Options, and the Change Information at the rear of this manual for any modifications which may affect this procedure.
- c. See the **TEST POINT AND ADJUSTMENT LOCATIONS G** foldout page in Section 8, Diagrams and Circuit Board Illustrations.
- d. Set the 7904A controls as follows:

| | |
|---------------------------------|--|
| POWER switch | On |
| VERTICAL MODE | RIGHT |
| VERT TRACE SEPARATION (B) | Midrange |
| A TRIGGER SOURCE | VERT MODE |
| A INTENSITY | Midrange |
| HORIZONTAL MODE | A |
| B INTENSITY | Midrange |
| B TRIGGER SOURCE | VERT MODE |
| READOUT INTENSITY | OFF (in detent) |
| GRAT ILLUM | Midrange |
| BEAMFINDER | Pushbutton out |
| Readout Selector Switch | Free Run (see Test Point and Adjustment Locations G.) |

G2. ADJUST READOUT VERTICAL SEPARATION, CENTERING AND CHARACTER HEIGHT (A15R2291, A18R737, A15R2273, A28R101, A28R114)

NOTE

First perform step G1, then proceed.

G2. SETUP CONDITIONS

7904A Controls:
No change in settings.

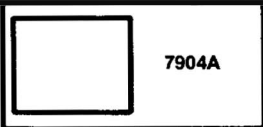

Test Equipment Controls:
No equipment necessary.

4593-545

- a. Set the POWER switch to OFF.
- b. Remove Q2225 from its socket on the A15 Readout System Board.
- c. Set the POWER switch to on.
- d. Set the READOUT INTENSITY control for visible characters (all zeros).

NOTE

The following tolerances are provided as guides to correct instrument operation and are not instrument specifications.

- e. **EXAMINE**—the crt display for two rows of zeros, 40 zeros to a row with no character overlap. The two rows of zeros should be located vertically in the middle of the top and bottom divisions of the graticule (see Fig. 5-4).

Checks and Adjustment—7904A
Part II—Adjustment and Performance Check

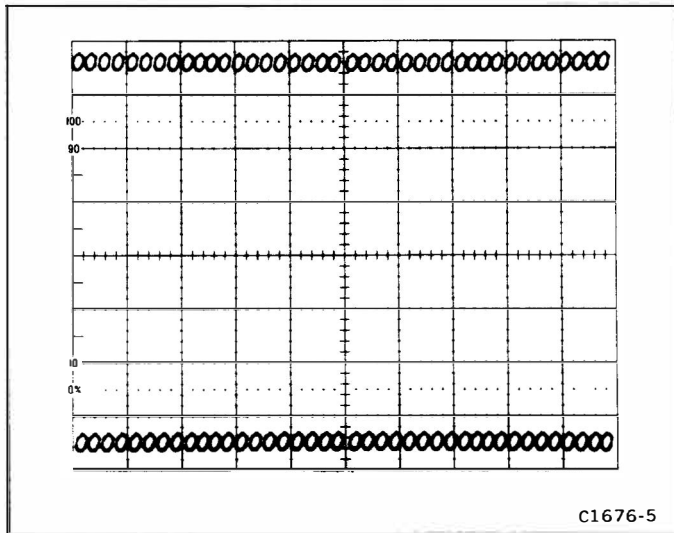

Figure 5-4. Readout display with Q2225 removed.

NOTE

The MVA Center (Main Vertical Amplifier) Adjustment R736 must be correct before making the next adjustment. Refer to F. Vertical System procedure.

- f. **ADJUST**—Vertical Separation adjustment, R2291 (on the A15 Readout System Board) and R/O Center adjustment, R737 (on the A18 Vertical Amplifier Board) to position the two rows of readout characters to the middle of the top and bottom divisions of the graticule. Set Character Height adjustment, R2273 (on the A15 Readout System Board) as desired.
- g. **EXAMINE**—display for two rows of zeros, 40 zeros to each row with no character overlap. Total length of each row of characters is between 9.5 and 10 divisions.
- h. **ADJUST**—RO Ctr adjustment R114, and RO Gain adjustment, R101 (on the A28 Horizontal Amplifier Board) to horizontally center the zeros display and to set the length of each row of characters to between 9.5 and 10 divisions.
- i. Set the POWER switch to OFF and replace Q2225 in its socket.

G3. ADJUST CHARACTER SCAN (A15R2128)

NOTE

If the preceding step was not performed, first perform step G1, then proceed.

G3. SETUP CONDITIONS

7904A Controls:
 POWER On
 VERTICAL MODE RIGHT

7904A

Amplifier
(Dual Channel)

Test Equipment Controls:
 Amplifier Unit
 Deflection Factors 50 mV/div
 Display Mode Dual trace
4593-546

- a. **EXAMINE**—the displayed characters for completeness without overscanning; overscanning causes a bright dot where traces overlap.
- b. **ADJUST**—Character Scan adjustment, R2128 (on the A15 Readout System Board) for fully scanned characters without overscanning. The m and the 5 will show the most change.

G4. ADJUST COLUMN AND ROW MATCH (A15R2214, A15R2183)

NOTE

If the preceding step was not performed, first perform step G1, then proceed.

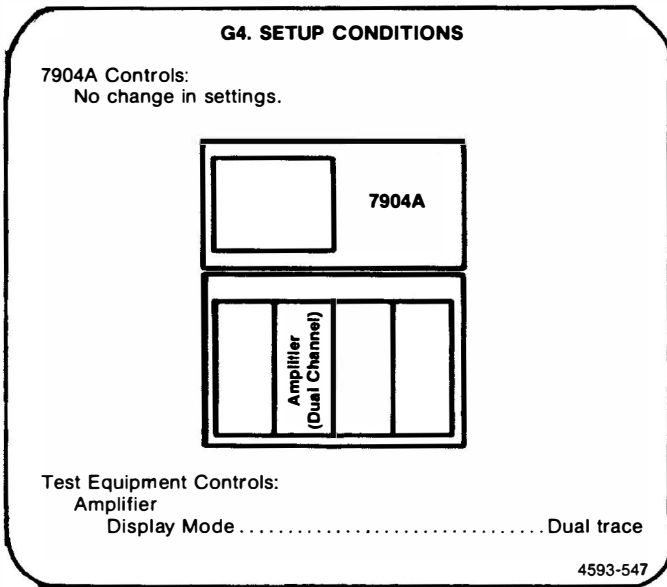

- a. Press and hold one of the amplifier trace-identify buttons.
- b. **EXAMINE**—the readout display for correct indication of "IDENTIFY." If the readout display is incorrect, adjustment is required.
- c. **ADJUST**—Column Match adjustment R2214, and Row Match adjustment, R2183 (on the A15 Readout System Board), for correct readout of "IDENTIFY." Set these adjustments to the center of the range which provides correct readout indication. Release the amplifier trace-identify button.

G5. CHECK READOUT MODES

NOTE

If the preceding step was not performed, first perform step G1, then proceed.

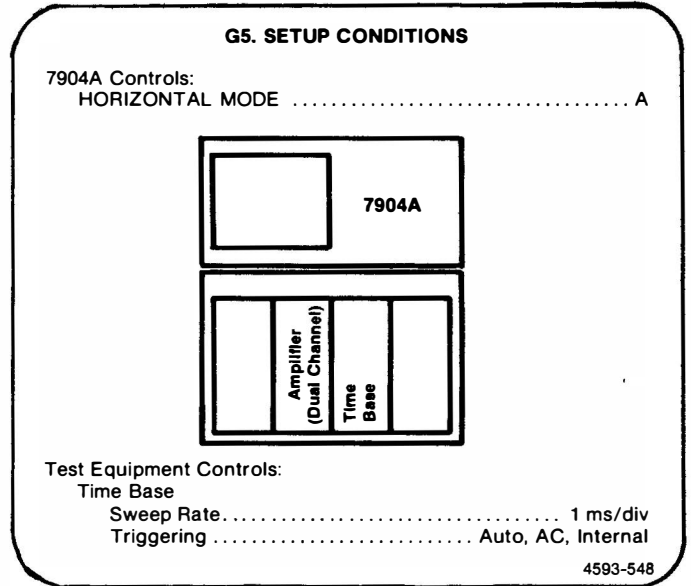

- a. Set the READOUT INTENSITY control for a visible display.
- b. **CHECK**—set the time-base to several sweep rates throughout its range, and check that the readout characters are displayed.
- c. Set the READOUT +GATE/EXT button to +GATE (pressed in) and set the READOUT INTENSITY control to PULSED.
- d. Set the +GATE mode switch to A.
- e. Set the READOUT PRESET control for a visible readout display.
- f. Set the time-base unit for a free-running (not triggered) sweep at a rate of 0.2 second/division.
- g. **CHECK**—that the readout characters are blanked out while the sweep is running, and are displayed immediately after the end of the sweep; each character encoded by the plug-in units is displayed only once for each sweep.
- h. Set the READOUT +GATE/EXT button to EXT (released).
- i. **CHECK**—press the READOUT MAN pushbutton and notice that one frame of readout is displayed.
- j. Turn POWER switch OFF. Replace the fan blade (removed at start of procedure for instruments with serial number below B040000), and the side covers.

G. READOUT SYSTEM SN B031767 & Above

Equipment Required: (Numbers correspond to those listed in Table 5-3, Test Equipment).

- | | |
|--|--------------------------|
| 1. Test Oscilloscope (with 10X probes) | 17. Screwdriver, slotted |
| 2. Amplifier, Dual-Channel | 19. Tool, Alignment |
| 4. Time Base | |

G1. READOUT SYSTEM PRELIMINARY SETUP

- a. Perform the Performance Check Power-Up Sequence.
- b. Refer to Section 6, Instrument Options, and the Change Information at the rear of this manual for any modifications which may affect this procedure.
- c. Set the 7904A controls as follows:

| | |
|---------------------------|---|
| POWER switch | On |
| VERTICAL MODE | RIGHT |
| VERT TRACE SEPARATION (B) | Midrange |
| A TRIGGER SOURCE | VERT MODE |
| A INTENSITY | Midrange |
| HORIZONTAL MODE | A |
| B INTENSITY | Midrange |
| B TRIGGER SOURCE | VERT MODE |
| READOUT INTENSITY | OFF (in detent) |
| GRAT ILLUM | Midrange |
| BEAMFINDER | Pushbutton out |
| READOUT MODE PLUG | |
| P2112 | Connect pins 1 & 2 (see Test Point and Adjustment Locations G). |

G2. ADJUST READOUT VERTICAL SEPARATION, CENTERING AND SIZE (A15R2260, A18R737, A15R2210, A28R101, A28R114)

NOTE

First perform step G1, then proceed.

G2. SETUP CONDITIONS

7904A Controls:
No change in settings.

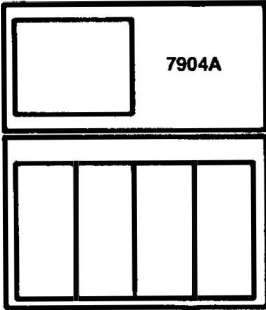

Test Equipment Controls:
No equipment necessary.

4593-545

- a. Set the POWER switch to OFF.
- b. Move Plug P2184 to Pins 2 and 3.
- c. Set the POWER switch to on.
- d. Set the READOUT INTENSITY control for visible characters (all zeros).

NOTE

The following tolerances are provided as guides to correct instrument operation and are not instrument specifications.

- e. **EXAMINE**—the crt display for two rows of zeros, 40 zeros to a row. The two rows of zeros should be located vertically in the middle of the top and bottom divisions of the graticule (see Fig. 5-4).

NOTE

The MVA Center (Main Vertical Amplifier) Adjustment R736 must be correct before making the next adjustment. Refer to F. Vertical System procedure.

- f. **ADJUST**—Vertical Separation adjustment, R2260 on the A15 Readout System Board and R/O Center adjustment, R737 (on the A18 Vertical Amplifier Board) to position the two rows of readout characters to the middle of the top and bottom divisions of the graticule. Set Character Size adjustment, R2210 on the A15 Readout System Board as desired.
- g. **EXAMINE**—display for two rows of zeros, 40 zeros to each row. Total length of each row of characters is between 9.5 and 10 divisions.
- h. **ADJUST**—RO Ctr adjustment R114, and RO Gain adjustment, R101 (on the A28 Horizontal Amplifier Board) to horizontally center the zeros display and to set the length of each row of characters to between 9.5 and 10 divisions.
- i. Set the POWER switch to OFF and replace Plug 2184 on Pins 1 and 2.

G3. ADJUST CHARACTER CLOCK (A15C2155)

NOTE

If the preceding step was not performed, first perform step G1, then proceed.

G3. SETUP CONDITIONS

7904A Controls:
 POWER On
 VERTICAL MODE RIGHT

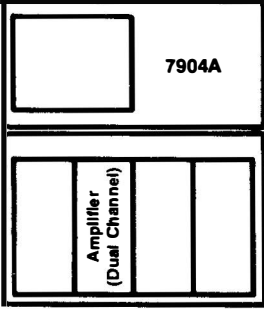

Test Equipment Controls:
 Amplifier Unit
 Deflection Factors 50 mV/div
 Display Mode Dual trace

4593-546

- a. Connect Test Oscilloscope Channel 1 to pin 12 of U2202 (on the A15 Readout System board).
- b. Set the Time Base sweep rate for 5 μ S/div, negative triggers.
- c. Set the Amplifier Unit Trigger Source to CH 1 and connect Channel 2 to pin 13 of U2202.
- d. **ADJUST**—C2155 (on A15 Readout System Board) for seventeen positive pulses on the Test Oscilloscope.

Checks and Adjustment—7904A
Part II—Adjustment and Performance Check

G4. ADJUST COLUMN AND ROW MATCH
(A15R2243, A15R2183)

NOTE

If the proceeding step was not performed, first perform step G1, then proceed.

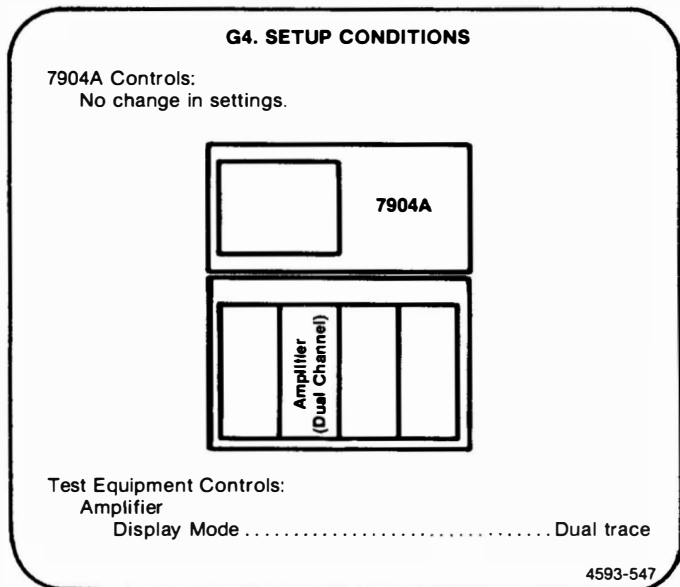

- a. Press and hold one of the amplifier trace-identity buttons.
- b. **EXAMINE**—the readout display for correct indication of "IDENTIFY". If the readout display is incorrect, adjustment is required.
- c. **ADJUST**—Column Match adjustment R2243, and Row Match adjustment, R2183 (on the A15 Readout System board), for correct readout of "IDENTIFY". Set these adjustments to the center of the range which provides correct readout indication. Release the amplifier trace-identify button.

G5. CHECK READOUT MODES

NOTE

If the proceeding step was not performed, first perform step G1, then proceed.

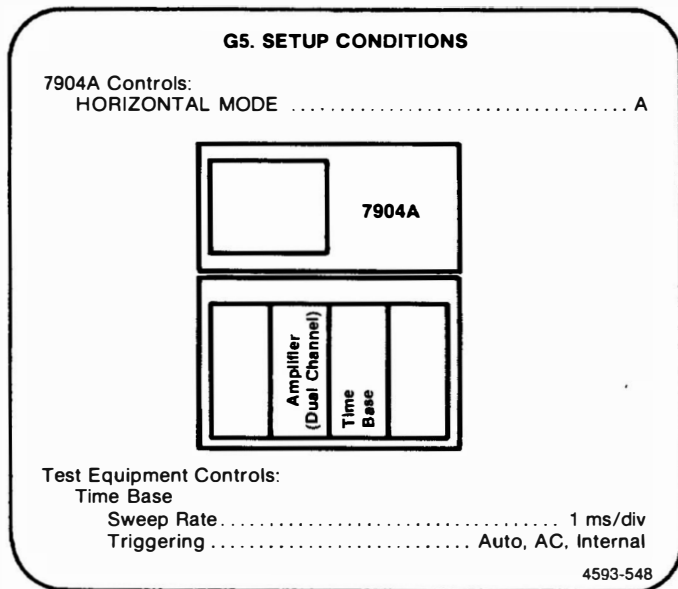

- a. Set the READOUT INTENSITY control for a visible display.
- b. **CHECK**—set the time-base to several sweep rates throughout its range, and check that the readout characters are displayed.
- c. Set the READOUT +GATE/EXT button to +GATE (pressed in) and set the READOUT INTENSITY control to PULSED.
- d. Set the +GATE mode switch to A.
- e. Set the READOUT PRESET control for a visible readout display.
- f. Set the time-base unit for a free-running (not triggered) sweep at a rate of 0.2 second/division.
- g. **CHECK**—that the readout characters are blanked out while the sweep is running, and are displayed immediately after the end of the sweep; each character encoded by the plug-in units is displayed only once for each sweep.
- h. Set the READOUT +GATE/EXT button to EXT (released).
- i. **CHECK**—press the READOUT MAN pushbutton and notice that one frame of readout is displayed.
- j. Turn POWER switch OFF. Replace the fan blade (removed at start of procedure), and the side covers.

This completes the Part II—Adjustment and Performance Check Procedure.

INSTRUMENT OPTIONS

Your 7904A Oscilloscope may be equipped with one or more instrument options. A brief description of each available option is given in the following discussion. Option information is incorporated into the appropriate sections of the manual. Refer to Table 6-1 and the Table of Contents for location of option information. For further information on instrument options, see your Tektronix Products catalog or contact your Tektronix Field Office.

WARNING

To avoid electric shock hazard, operating personnel must not remove the protective instrument covers. Component replacement and internal adjustments must be made by qualified service personnel only.

OPTION 2

Option 2 provides phase correction when operating in the X-Y Mode. A delay compensation network is added to equalizes the signal delay between the vertical and horizontal deflection systems. When the compensation network is installed and activated, the phase shift between the vertical and horizontal channels is adjustable to less than 2° from dc to 1 megahertz.

Option 2 can be added at any time. Refer to your Tektronix Products catalog or contact your local Tektronix Field Office.

OPTION 3

Option 3 enables the 7904A to meet the EMC (electromagnetic compatibility) specifications given in Section 1—General Information of this manual.

Option 3 can be added at any time. Refer to your Tektronix Products catalog or contact your local Tektronix Field Office.

OPTION 4

Option 4 provides a 4 cm × 5 cm crt display with P31 phosphor.

OPTION 13

Option 13 provides a 4 cm × 5 cm crt display with P11 phosphor.

OPTION 78

Option 78 provides a 8 cm × 10 cm crt display with P11 phosphor.

OPTION A1

The standard power cord is replaced with Universal European 240-volt type power cord.

OPTION A2

The standard power cord is replaced with the United Kingdom 240-volt type power cord.

OPTION A3

The standard power cord is replaced with the Australian 240-volt type power cord.

OPTION A4

The standard power cord is replaced with the North American 240-volt type power cord.

OPTION A5

The standard power cord is replaced with the Switzerland 220V/10A type power cord.

INSTRUMENT OPTION IDENTIFICATION

Options 2, 3, 4, 13, and 78 are identified by labels on the 7904A rear panel.

To identify Power-Cord Options A1, A2, A3, A4, and A5 refer to Table 1-2 to determine the type of power cord used with your instrument.

TABLE 6-1
Option Information Locator

| Instrument Option | Location | | Information |
|--|-----------------------------|---|--|
| | Manual Section | Heading | |
| Option 2 (X-Y mode phase correction) | 1 General Information | Table 1-3 Electrical Characteristics (HORIZONTAL SYSTEM) | Horizontal System performance requirements. |
| | 2 Operating Instructions | X-Y Operation | Horizontal delay description. |
| | 3 Theory of Operation | Description | A and B HORIZ signal. |
| | | X-Y Delay Compensation (Option 2) | Delay compensation network circuit description. |
| | 5 Checks and Adjustment | Part I Performance Check (Step D4. Check X-Y Delay Compensation) | Performance Check procedure. |
| Part II Adjustment and Performance Check (Step E8. Check/Adjust X-Y Delay Compensation) | | Adjustment and Performance Check procedure. | |
| Option 3 (Electromagnetic Compatibility) | 2 Operating Instructions | Light Filter | EMI and light filter description. |
| | 4 Maintenance | Cabinet Panel Removal | Warning against personal injury. |
| | | CRT | Crt mesh filter cleaning instructions. |
| Option 4 (4 x 5 cm display with P31 phosphor) | 1 General Information | Table 1-3 Electrical Characteristics (DISPLAY) | Graticule area display specifications, phosphor type, and writing speed. |
| Option 13 (4 x 5 cm display with P11 phosphor) | 1 General Information | Table 1-3 Electrical Characteristics (DISPLAY) | Graticule area display specifications, phosphor type, and writing speed. |
| Option 78 (8 x 10 cm display with P11 phosphor) | 1 General Information | Table 1-3 Electrical Characteristics (DISPLAY) | Graticule area display specifications, phosphor type, and writing speed. |
| Option A1 (Universal European 240-volt power cord) | 1 General Information | Table 1-2 Power-Cord and Plug Identification Information | Plug configurations, usage and reference standards. |

TABLE 6-1 (CONT)
Option Information Locator

| Instrument Option | Location | | Information |
|--|-----------------------------|---|---|
| | Manual Section | Heading | |
| Option A2 (United Kingdom 240-volt power cord) | 1 General Information | Table 1-2 Power-Cord and Plug Identification Information | Plug configurations, usage, and reference standards. |
| Option A3 (Australian 240-volt power cord) | 1 General Information | Table 1-2 Power-Cord and Plug Identification Information | Plug configurations, usage, and reference standards. |
| Option A4 (North American 240-volt power cord) | 1 General Information | Table 1-2 Power-Cord and Plug Identification Information | Plug configurations, usage, and reference standards. |
| Option A5 (Switzerland 220 V/10 A power cord) | 1 General Information | Table 1-2 Power-Cord and Plug Identification Information | Plug configurations, usage, and reference standards. |

REPLACEABLE ELECTRICAL PARTS

PARTS ORDERING INFORMATION

Replacement parts are available from or through your local Tektronix, Inc. Field Office or representative

Changes to Tektronix instruments are sometimes made to accommodate improved components as they become available, and to give you the benefit of the latest circuit improvements developed in our engineering department. It is therefore important, when ordering parts, to include the following information in your order: Part number, instrument type or number, serial number, and modification number if applicable.

If a part you have ordered has been replaced with a new or improved part, your local Tektronix, Inc. Field Office or representative will contact you concerning any change in part number.

Change information, if any, is located at the rear of this manual

Only the circuit number will appear on the diagrams and circuit board illustrations. Each diagram and circuit board illustration is clearly marked with the assembly number. Assembly numbers are also marked on the mechanical exploded views located in the Mechanical Parts List. The component number is obtained by adding the assembly number prefix to the circuit number.

The Electrical Parts List is divided and arranged by assemblies in numerical sequence (e.g., assembly A1 with its subassemblies and parts, precedes assembly A2 with its subassemblies and parts).

Chassis-mounted parts have no assembly number prefix and are located at the end of the Electrical Parts List

LIST OF ASSEMBLIES

A list of assemblies can be found at the beginning of the Electrical Parts List. The assemblies are listed in numerical order. When the complete component number of a part is known, this list will identify the assembly in which the part is located.

CROSS INDEX-MFR. CODE NUMBER TO MANUFACTURER

The Mfr. Code Number to Manufacturer index for the Electrical Parts List is located immediately after this page. The Cross Index provides codes, names and addresses of manufacturers of components listed in the Electrical Parts List.

ABBREVIATIONS

Abbreviations conform to American National Standard Y 1.1.

COMPONENT NUMBER (column one of the Electrical Parts List)

A numbering method has been used to identify assemblies, subassemblies and parts. Examples of this numbering method and typical expansions are illustrated by the following:

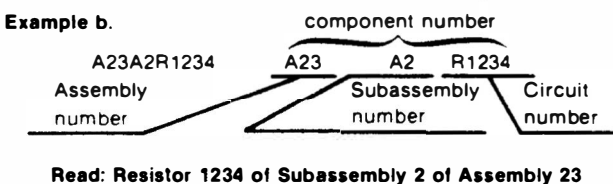
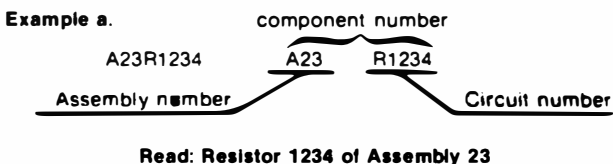

TEKTRONIX PART NO. (column two of the Electrical Parts List)

Indicates part number to be used when ordering replacement part from Tektronix.

SERIAL/MODEL NO. (columns three and four of the Electrical Parts List)

Column three (3) indicates the serial number at which the part was first used. Column four (4) indicates the serial number at which the part was removed. No serial number entered indicates part is good for all serial numbers.

NAME & DESCRIPTION (column five of the Electrical Parts List)

In the Parts List, an Item Name is separated from the description by a colon (:). Because of space limitations, an Item Name may sometimes appear as incomplete. For further Item Name identification, the U.S. Federal Cataloging Handbook H6-1 can be utilized where possible.

MFR. CODE (column six of the Electrical Parts List)

Indicates the code number of the actual manufacturer of the part. (Code to name and address cross reference can be found immediately after this page.)

MFR. PART NUMBER (column seven of the Electrical Parts List)

Indicates actual manufacturers part number.

CROSS INDEX - MFR. CODE NUMBER TO MANUFACTURER

| Mfr. Code | Manufacturer | Address | City, State, Zip Code |
|-----------|---|---------------------------------------|-----------------------------|
| 00213 | NYTRONICS COMPONENTS GROUP INC SUBSIDIARY OF NYTRONICS INC | ORANGE ST | DARLINGTON SC 29532 |
| 00779 | AMP INC | 2800 FULLING MILL PO BOX 3608 | HARRISBURG PA 17105 |
| 00853 | SANGAMO WESTON INC COMPONENTS DIV | SANGAMO RD PO BOX 128 | PICKENS SC 29671-9716 |
| 01121 | ALLEN-BRADLEY CO | 1201 S 2ND ST | MILWAUKEE WI 53204-2410 |
| 01295 | TEXAS INSTRUMENTS INC SEMICONDUCTOR GROUP | 13500 N CENTRAL EXPY PO BOX 655012 | DALLAS TX 75265 |
| 02111 | HAMILTON STANDARD CONTROLS INC SPECTROL DIV | 17070 E GALE AVE P O BOX 1220 | CITY OF INDUSTRY CA 91749 |
| 02114 | AMPEREX ELECTRONIC CORP FERROXCUBE DIV | 5083 KINGS HWY | SAUGERTIES NY 12477 |
| 02735 | RCA CORP SOLID STATE DIVISION | ROUTE 202 | SOMERVILLE NJ 08876 |
| 02777 | HOPKINS ENGINEERING CO | 12900 FOOTHILL BLVD | SAN FERNANDO CA 91342-4928 |
| 03508 | GENERAL ELECTRIC CO SEMI-CONDUCTOR PRODUCTS DEPT | W GENESEE ST | AUBURN NY 13021 |
| 04072 | BELL INDUSTRIES JW MILLER DIVISION | | COMPTON CA 94539 |
| 04099 | CAPCO INC | 1328 WINTERS AVE PO BOX 1028 | GRAND JUNCTION CO 81502 |
| 04222 | AVX CERAMICS DIV OF AVX CORP | 19TH AVE SOUTH P O BOX 867 | MYRTLE BEACH SC 29577 |
| 04713 | MOTOROLA INC SEMICONDUCTOR PRODUCTS SECTOR | 5005 E MCDOWELL RD | PHOENIX AZ 85008-4229 |
| 05397 | UNION CARBIDE CORP MATERIALS SYSTEMS DIV | 11901 MADISON AVE | CLEVELAND OH 44101 |
| 05828 | GENERAL INSTRUMENT CORP GOVERNMENT SYSTEMS DIV | 600 W JOHN ST | HICKSVILLE NY 11802 |
| 07263 | FAIRCHILD SEMICONDUCTOR CORP NORTH AMERICAN SALES | 10400 RIDGEVIEW CT | CUPERTINO CA 95014 |
| 07716 | SUB OF SCHLUMBERGER LTD MS 118 TRW INC | 2850 MT PLEASANT AVE | BURLINGTON IA 52601 |
| 11236 | TRW IRC FIXED RESISTORS/BURLINGTON CTS CORP | 406 PARR ROAD | BERNE IN 46711-9506 |
| 12954 | BERNE DIV THICK FILM PRODUCTS GROUP MICROSEMI CORP - SCOTTSDALE | 8700 E THOMAS RD P O BOX 1390 | SCOTTSDALE AZ 85252 |
| 12969 | UNITRODE CORP | 5 FORBES RD | LEXINGTON MA 02173-7305 |
| 14193 | CAL-R INC | 1601 OLYMPIC BLVD PO BOX 1397 | SANTA MONICA CA 90406 |
| 14433 | ITT SEMICONDUCTORS DIV | | WEST PALM BEACH FL |
| 14552 | MICROSEMI CORP | 2830 S FAIRVIEW ST | SANTA ANA CA 92704-5948 |
| 14731 | HARRIS GRAPHICS CORP PUBLICATION PRESS DIV | MECHANIC ST PO BOX 515 | WESTERLY RI 02891 |
| 14752 | ELECTRO CUBE INC | 1710 S DEL MAR AVE | SAN GABRIEL CA 91776-3825 |
| 14936 | GENERAL INSTRUMENT CORP DISCRETE SEMI CONDUCTOR DIV | 600 W JOHN ST | HICKSVILLE NY 11802 |
| 15238 | ITT SEMICONDUCTORS A DIVISION OF INTERNATIONAL TELEPHONE AND TELEGRAPH CORP | 500 BROADWAY PO BOX 168 | LAWRENCE MA 01841-3002 |
| 15454 | AMETEK INC RODAN DIV | 721 N POPLAR ST | ORANGE CA 92668 |
| 18235 | KRL ELECTRONICS INC | 160 BOUCHARD ST | MANCHESTER NH 03103-3315 |
| 18324 | SIGNETICS CORP MILITARY PRODUCTS DIV | 4130 S MARKET COURT | SACRAMENTO CA 95834-1222 |
| 19396 | ILLINOIS TOOL WORKS INC PAKTRON DIV | 1205 MCCONVILLE RD PO BOX 4539 | LYNCHBURG VA 24502-4535 |
| 19701 | MEPCO/CENTRALAB A NORTH AMERICAN PHILIPS CO | PO BOX 760 | MINERAL WELLS TX 76067-0760 |
| 21847 | MINERAL WELLS AIRPORT FEI MICROWAVE INC | 825 STEWART DR | SUNNYVALE CA 94086-4514 |

CROSS INDEX - MFR. CODE NUMBER TO MANUFACTURER

| Mfr. Code | Manufacturer | Address | City, State, Zip Code |
|-----------|--|---|--------------------------------|
| 22526 | DU PONT E I DE NEMOURS AND CO INC DU PONT CONNECTOR SYSTEMS DIV MILITARY PRODUCTS GROUP | 515 FISHING CREEK RD | NEW CUMBERLAND PA 17070-3007 |
| 24546 | CORNING GLASS WORKS | 550 HIGH ST | BRADFORD PA 16701-3737 |
| 25088 | SIEMENS CORP | 186 WOOD AVE S | ISELIN NJ 08830-2704 |
| 25403 | AMPEREX ELECTRONIC CORP SEMICONDUCTOR SOLID STATE AND ACTIVE DEVICES-ELECTRO OPTICAL DEVICES | GEORGE WASHINGTON HWY | SMITHFIELD RI 02917 |
| 27014 | NATIONAL SEMICONDUCTOR CORP | 2900 SEMICONDUCTOR DR | SANTA CLARA CA 95051-0606 |
| 31918 | ITT SCHADOW INC | 8081 WALLACE RD | EDEN PRAIRIE MN 55344-2224 |
| 32997 | BOURNS INC TRIMPOT DIV | 1200 COLUMBIA AVE | RIVERSIDE CA 92507-2114 |
| 33095 | SPECTRUM CONTROL INC | 2185 W WEIGHT ST | ERIE PA 16505 |
| 44655 | OHMITE MFG CO | 3601 W HOWARD ST | SKOKIE IL 60076-4014 |
| 50434 | HEWLETT-PACKARD CO OPTOELECTRONICS DIV | 370 W TRIMBLE RD | SAN JOSE CA 95131 |
| 50558 | ELECTRONIC CONCEPTS INC | 526 INDUSTRIAL WAY W | EATONTOWN NJ 07724-2212 |
| 51406 | MURATA ERIE NORTH AMERICA INC HEADQUARTERS AND GEORGIA OPERATIONS | 2200 LAKE PARK DR | SMYRNA GA 30080 |
| 51642 | CENTRE ENGINEERING INC | 2820 E COLLEGE AVE | STATE COLLEGE PA 16801-7515 |
| 52306 | UNITRODE CORP HIGH VOLTAGE DEVICES INC | | VISALIA CA |
| 52763 | STETCO INC | 3344 SCHIERHORN | FRANKLIN PARK IL 60131 |
| 52769 | SPRAGUE-GOODMAN ELECTRONICS INC | 134 FULTON AVE | GARDEN CITY PARK NY 11040-5352 |
| 54473 | MATSUSHITA ELECTRIC CORP OF AMERICA | ONE PANASONIC WAY PO BOX 1501 | SECAUCUS NJ 07094-2917 |
| 54937 | DEYOUNG MANUFACTURING INC | 12920 NE 125TH WAY | KIRKLAND WA 98034-7716 |
| 55112 | WESTLAKE CAPACITORS INC | 5334 STERLING CENTER DRIVE | WESTLAKE VILLAGE CA 91361 |
| 55292 | WILBRECHT ELECTRONICS INC LEDCO DIV | 240 E PLATO BLVD | ST PAUL MN 55107-1609 |
| 55680 | NICHICON /AMERICA/ CORP | 927 E STATE PKY | SCHAUMBURG IL 60195-4526 |
| 56289 | SPRAGUE ELECTRIC CO WORLD HEADQUARTERS | 92 HAYDEN AVE | LEXINGTON MA 02173-7929 |
| 57668 | ROHM CORP | 8 WHATNEY PO BOX 19515 | IRVINE CA 92713 |
| 58854 | GTE PRODUCTS CORP LIGHTING PRODUCTS GROUP | 60 BOSTON ST | SALEM MA 01970-2147 |
| 59660 | TUSONIX INC | 7741 N BUSINESS PARK DR PO BOX 37144 | TUCSON AZ 85740-7144 |
| 59821 | MEPCO/CENTRALAB A NORTH AMERICAN PHILIPS CO | 7158 MERCHANT AVE | EL PASO TX 79915-1207 |
| 60211 | VOLTAGE MULTIPLIERS INC | 8711 W ROOSEVELT | VISALIA CA 93291-9458 |
| 60705 | CERA-MITE CORPORATION | 1327 6TH AVE | GRAFTON WI 53024-1831 |
| 71400 | BUSSMANN DIV OF COOPER INDUSTRIES INC | 114 OLD STATE RD PO BOX 14460 | ST LOUIS MO 63178 |
| 72982 | ERIE SPECIALTY PRODUCTS INC | 645 W 11TH ST | ERIE PA 16512 |
| 73138 | BECKMAN INDUSTRIAL CORP BECKMAN ELECTRONIC TECHNOLOGIES SUB OF EMERSON ELECTRIC | 4141 PALM ST | FULLERTON CA 92635 |
| 74970 | JOHNSON E F CO | 299 10TH AVE S W | WASECA MN 56093-2539 |
| 75042 | IRC ELECTRONIC COMPONENTS PHILADELPHIA DIV TRW FIXED RESISTORS | 401 N BROAD ST | PHILADELPHIA PA 19108-1001 |
| 75498 | MULTICOMP INC | 3005 SW 154TH TERRACE #3 | BEAVERTON OR 97006 |
| 76493 | BELL INDUSTRIES INC JW MILLER DIV | 19070 REYES AVE PO BOX 5825 | COMPTON CA 90224-5825 |
| 77342 | AMF INC POTTER AND BRUMFIELD DIV | 200 RICHLAND CREEK DR | PRINCETON IN 47670-4771 |
| 79727 | C-W INDUSTRIES | 130 JAMES WAY | SOUTHAMPTON PA 18966-3818 |
| 80009 | TEKTRONIX INC | 14150 SW KARL BRAUN DR PO BOX 500 | BEAVERTON OR 97077-0001 |
| 82389 | SWITCHCRAFT INC SUB OF RAYTHEON CO | 5555 N ELSTRON AVE | CHICAGO IL 60630-1314 |
| 84411 | AMERICAN SHIZUKI CORP OGALLALA OPERATIONS | 301 WEST O ST | OGALLALA NE 69153-1844 |

CROSS INDEX - MFR. CODE NUMBER TO MANUFACTURER

| Mfr. Code | Manufacturer | Address | City, State, Zip Code |
|-----------|--|-----------------------------|------------------------|
| 91637 | DALE ELECTRONICS INC | 2064 12TH AVE PO BOX 609 | COLUMBUS NE 68601-3632 |
| 92966 | GTE PRODUCTS CORP LIGHTING PRODUCTS GROUP HILLSBORO MINIATURE LAMP PLANT | WEST MAIN ST | HILLSBORO NH 03244 |
| TK0213 | TOPTRON CORP | | TOKYO JAPAN |
| TK0271 | COMPONENT CONCEPTS INC | 3229 PINE ST | EVERETT WA 98201-4536 |
| TK1345 | ZMAN AND ASSOCIATES | 7633 S 180TH | KENT WA 98032 |
| TK1450 | TOKYO COSMOS ELECTRIC CO LTD | 2-268 SOBUDAI ZAWA | KANAGAWA 228 JAPAN |
| TK2038 | MULTICOMP INC | 3005 SW 154TH TERRACE #3 | BEAVERTON OR 97006 |
| TK2042 | ZMAN & ASSOCIATES | 7633 S 180TH | KENT WA 98032 |

| Component No. | Tektronix Part No. | Serial/Assembly No. Effective | Discont | Name & Description | Mfr. Code | Mfr. Part No. |
|---------------|--------------------|-------------------------------|---------|---|-----------|---------------|
| A1 | 670-8060-00 | B010100 | B042057 | CIRCUIT BD ASSY:FRONT PANEL | 80009 | 670-8060-00 |
| A1 | 670-8060-01 | B042058 | | CIRCUIT 8D ASSY:FRONT PANEL | 80009 | 670-8060-01 |
| A2 | 670-5227-01 | | | CIRCUIT BD ASSY:DISPLAY CONTROLLER | 80009 | 670-5227-01 |
| A3 | 670-4778-01 | | | CIRCUIT BD ASSY:TRIGGER LIGHT | 80009 | 670-4778-01 |
| A4 | 670-4778-01 | | | CIRCUIT BD ASSY:TRIGGER LIGHT | 80009 | 670-4778-01 |
| A5 | 670-4773-04 | | | CIRCUIT 8D ASSY:MODE SW | 80009 | 670-4773-04 |
| A6 | 670-4775-00 | B010100 | B010939 | CIRCUIT BD ASSY:MAIN INTERFACE | 80009 | 670-4775-00 |
| A6 | 670-4775-01 | B010940 | B031870 | CIRCUIT BD ASSY:MAIN INTERFACE | 80009 | 670-4775-01 |
| A6 | 670-4775-02 | B031871 | | CIRCUIT BD ASSY:MAIN INTFC | 80009 | 670-4775-02 |
| A7 | 670-8051-00 | | | CIRCUIT BD ASSY:FRONT PANEL DISPLAY | 80009 | 670-8051-00 |
| A8 | 670-8051-00 | | | CIRCUIT BD ASSY:FRONT PANEL DISPLAY | 80009 | 670-8051-00 |
| A9 | 670-8054-00 | | | CIRCUIT BD ASSY:FRONT PANEL DISPLAY | 80009 | 670-8054-00 |
| A10 | 670-8055-00 | | | CIRCUIT BD ASSY:FRONT PANEL DISPLAY | 80009 | 670-8055-00 |
| A11 | 670-4641-00 | | | CIRCUIT BD ASSY:FAN | 80009 | 670-4641-00 |
| A12 | 620-0283-01 | | | POWER SUPPLY:LOW VOLTAGE (INCLUDES A12,A22,A23 ASSEMBLIES) | 80009 | 620-0283-01 |
| A12A1 | 670-5959-03 | B010100 | B031832 | CIRCUIT BD ASSY:CONTROLLED RECTIFIER | 80009 | 670-5959-03 |
| A12A1 | 670-5959-04 | B031833 | B042342 | CIRCUIT BD ASSY:CONTROLLED RECTIFIER | 80009 | 670-5959-04 |
| A12A1 | 670-5959-05 | B042343 | | CIRCUIT BD ASSY:CONTROLLER RECTIFIER (PART OF 620-0283-XX) | 80009 | 670-5959-05 |
| A13 | 670-4777-20 | | | CIRCUIT BD ASSY:LOGIC | 80009 | 670-4777-20 |
| A14 | 670-4776-20 | | | CIRCUIT BD ASSY:TRIGGER SELECT | 80009 | 670-4776-20 |
| A15 | 672-0572-00 | B010100 | B029999 | CIRCUIT BD ASSY:READOUT PROTECTION #1 | 80009 | 672-0572-00 |
| A15 | 672-0572-01 | B030000 | 8031800 | CIRCUIT 8D ASSY:READOUT PROTECTION #1 | 80009 | 672-0572-01 |
| A15 | 672-0572-02 | B031801 | B041951 | CIRCUIT BD ASSY:READOUT PROTECTION #1 | 80009 | 672-0572-02 |
| A15 | 672-0572-05 | B041952 | B042193 | CIRCUIT BD ASSY:READOUT PROTECTION #1 | 80009 | 672-0572-05 |
| A15 | 672-0572-06 | B042194 | 8042314 | CIRCUIT BD ASSY:READOUT PROTECTION #1 | 80009 | 672-0572-06 |
| A15 | 672-0572-07 | 8042315 | 8042481 | CIRCUIT BD ASSY:READOUT PRO #1 | 80009 | 672-0572-07 |
| A15 | 672-0572-08 | 8042482 | | CIRCUIT 8D ASSY:READOUT PRO #1 (INCLUDES A15A1,A27 ASSEMBLIES) | 80009 | 672-0572-08 |
| A15A1 | 670-1900-06 | B010100 | 8029999 | CIRCUIT BD ASSY:READOUT (PART OF 672-0572-XX) | 80009 | 670-1900-06 |
| A15A1 | 670-8620-00 | B030000 | B031800 | CIRCUIT BD ASSY:READOUT (PART OF 672-0572-XX) | 80009 | 670-8620-00 |
| A15A1 | 670-8620-01 | B031801 | B041951 | CIRCUIT BD ASSY:READOUT | 80009 | 670-8620-01 |
| A15A1 | 670-8620-04 | B041952 | B042193 | CIRCUIT BD ASSY:READOUT (PART OF 672-0572-XX) | 80009 | 670-8620-04 |
| A15A1 | 670-8620-05 | B042194 | 8042314 | CIRCUIT BD ASSY:READOUT (PART OF 672-0572-XX) | 80009 | 670-8620-05 |
| A15A1 | 670-8620-06 | B042315 | B042481 | CIRCUIT BD ASSY:READOUT | 80009 | 670-8620-06 |
| A15A1 | 670-8620-07 | B042482 | | CIRCUIT BD ASSY:READOUT | 80009 | 670-8620-07 |
| A16 | 670-4769-20 | | | CIRCUIT BD ASSY:VERTICAL CHANNEL SWITCH | 80009 | 670-4769-20 |
| A17 | 670-1633-00 | | | CIRCUIT BD ASSY:X+Y DELAY COMPENSATION (OPTION 02 ONLY) | 80009 | 670-1633-00 |
| A18 | 670-7922-00 | | | CIRCUIT BD ASSY:VERT AMP (PART OF 672-1176-00) | 80009 | 670-7922-00 |
| A19 | 670-1634-00 | | | CIRCUIT BD ASSY:HORIZONTAL INTERCONNECT (REMOVE FOR OPTION 02) | 80009 | 670-1634-00 |
| A20 | 670-5841-20 | B010100 | B021129 | CIRCUIT BD ASSY:HV | 80009 | 670-5841-20 |
| A20 | 670-5841-21 | B021130 | | CIRCUIT BD ASSY:HV | 80009 | 670-5841-21 |
| A21 | 670-5834-20 | B010100 | B021636 | CIRCUIT BD ASSY:Z AXIS | 80009 | 670-5834-20 |
| A21 | 670-5834-21 | B021637 | | CIRCUIT BD ASSY:Z AXIS | 80009 | 670-5834-21 |
| A22 | 670-5960-03 | 8010100 | B031870 | CIRCUIT BD ASSY:LOW VOLTAGE REGULATOR | 80009 | 670-5960-03 |
| A22 | 670-5960-04 | B031871 | | CIRCUIT BD ASSY:LV REGULATOR | 80009 | 670-5960-04 |
| A23 | 670-6259-01 | B010100 | B019999 | CIRCUIT BD ASSY:INVERTER | 80009 | 670-6259-01 |
| A23 | 670-6259-02 | B020000 | | CIRCUIT BD ASSY:INVERTER (PART OF 620-0283-02) | 80009 | 670-6259-02 |
| A24 | 119-1048-00 | | | DELAY LINE,ELEC:65NS,50 OHMS (NO ELECTRICAL PARTS) | 80009 | 119-1048-00 |
| A25 | 670-8052-00 | | | CIRCUIT BD ASSY:FRONT PANEL DISPLAY | 80009 | 670-8052-00 |

Replaceable Electrical Parts - 7904A

| Component No. | Tektronix Part No. | Serial/Assembly No. Effective | Dscont | Name & Description | Mfr. Code | Mfr. Part No. |
|---------------|--------------------|-------------------------------|---------|---|-----------|-----------------|
| A26 | 670-8053-00 | | | CIRCUIT BD ASSY:FRONT PANEL DISPLAY | 80009 | 670-8053-00 |
| A27 | 670-4346-00 | | | CIRCUIT BD ASSY:READOUT PROTECTION #1 (PART OF 672-0572-00) | 80009 | 670-4346-00 |
| A28 | 670-1632-05 | B010100 | B010768 | CIRCUIT BD ASSY:MAIN HORIZONTAL AMP | 80009 | 670-1632-05 |
| A28 | 670-1632-06 | B010769 | | CIRCUIT BD ASSY:HORIZONTAL AMPLIFIER | 80009 | 670-1632-06 |
| A29 | 670-8059-00 | | | CIRCUIT BD ASSY:HORIZONTAL INTERCONNECT | 80009 | 670-8059-00 |
| A30 | 670-0702-06 | | | CIRCUIT BD ASSY:GRATICULE LAMPS | 80009 | 670-0702-06 |
| A31 | 670-8046-00 | | | CIRCUIT BD ASSY:FLEX CON (PART OF 672-1176-00.NO ELEC PARTS) | 80009 | 670-8046-00 |
| A1 | 670-8060-00 | B010100 | B042057 | CIRCUIT BD ASSY:FRONT PANEL | 80009 | 670-8060-00 |
| A1 | 670-8060-01 | B042058 | | CIRCUIT BD ASSY:FRONT PANEL | 80009 | 670-8060-01 |
| A1C1901 | 281-0773-00 | | | CAP,FXD,CER DI:0.01UF,10%,100V | 04222 | MA201C103KAA |
| A1C1904 | 281-0812-00 | | | CAP,FXD,CER DI:1000PF,10%,100V | 04222 | MA101C102KAA |
| A1C1906 | 281-0812-00 | | | CAP,FXD,CER DI:1000PF,10%,100V | 04222 | MA101C102KAA |
| A1C1908 | 290-0187-00 | | | CAP,FXD,ELCTLT:4.7UF,20%,35V | 05397 | T110B475M035AS |
| A1C1914 | 281-0763-00 | | | CAP,FXD,CER DI:47PF,10%,100V | 04222 | MA101A470KAA |
| A1C1918 | 281-0812-00 | | | CAP,FXD,CER DI:1000PF,10%,100V | 04222 | MA101C102KAA |
| A1C1919 | 281-0773-00 | | | CAP,FXD,CER DI:0.01UF,10%,100V | 04222 | MA201C103KAA |
| A1C1920 | 281-0773-00 | | | CAP,FXD,CER DI:0.01UF,10%,100V | 04222 | MA201C103KAA |
| A1C1921 | 281-0813-00 | | | CAP,FXD,CER DI:0.047UF,20%,50V | 05397 | C412C473M5V2CA |
| A1C1935 | 281-0797-00 | B010100 | B042057 | CAP,FXD,CER DI:15PF,10%,100V | 04222 | SA106A150KAA |
| A1C1935 | 281-0759-00 | B042058 | | CAP,FXD,CER DI:22PF,10%,100V | 04222 | MA101A220KAA |
| A1C1938 | 281-0812-00 | | | CAP,FXD,CER DI:1000PF,10%,100V | 04222 | MA101C102KAA |
| A1C1950 | 281-0775-00 | | | CAP,FXD,CER DI:0.1UF,20%,50V | 04222 | MA205E104MAA |
| A1C1952 | 281-0786-00 | | | CAP,FXD,CER DI:150PF,10%,100V | 04222 | MA101A151KAA |
| A1C1953 | 281-0775-00 | | | CAP,FXD,CER DI:0.1UF,20%,50V | 04222 | MA205E104MAA |
| A1C1955 | 290-0804-00 | | | CAP,FXD,ELCTLT:10UF,+50-20%,25V | 55680 | ULB1E100TAAANA |
| A1C1956 | 290-0745-00 | | | CAP,FXD,ELCTLT:22UF,+50-20%,25WVDC | 54473 | ECE-A25V22L |
| A1C1994 | 281-0775-00 | | | CAP,FXD,CER DI:0.1UF,20%,50V | 04222 | MA205E104MAA |
| A1C1995 | 290-0804-00 | | | CAP,FXD,ELCTLT:10UF,+50-20%,25V | 55680 | ULB1E100TAAANA |
| A1C1997 | 290-0804-00 | | | CAP,FXD,ELCTLT:10UF,+50-20%,25V | 55680 | ULB1E100TAAANA |
| A1CR1900 | 152-0141-02 | | | SEMICOND DVC,DI:SW,S1,30V,150MA,30V,DO-35 | 03508 | DA2527 (1N4152) |
| A1CR1902 | 152-0141-02 | | | SEMICOND DVC,DI:SW,S1,30V,150MA,30V,DO-35 | 03508 | DA2527 (1N4152) |
| A1CR1916 | 152-0322-00 | | | SEMICOND DVC,DI:SCHOTTKY,S1,15V,1.2PF,DO-35 | 50434 | 5082-2672 |
| A1CR1918 | 152-0141-02 | | | SEMICOND DVC,DI:SW,S1,30V,150MA,30V,DO-35 | 03508 | DA2527 (1N4152) |
| A1CR1922 | 152-0141-02 | | | SEMICOND DVC,DI:SW,S1,30V,150MA,30V,DO-35 | 03508 | DA2527 (1N4152) |
| A1CR1923 | 152-0141-02 | | | SEMICOND DVC,DI:SW,S1,30V,150MA,30V,DO-35 | 03508 | DA2527 (1N4152) |
| A1CR1927 | 152-0141-02 | | | SEMICOND DVC,DI:SW,S1,30V,150MA,30V,DO-35 | 03508 | DA2527 (1N4152) |
| A1CR1928 | 152-0141-02 | | | SEMICOND DVC,DI:SW,S1,30V,150MA,30V,DO-35 | 03508 | DA2527 (1N4152) |
| A1CR1929 | 152-0141-02 | | | SEMICOND DVC,DI:SW,S1,30V,150MA,30V,DO-35 | 03508 | DA2527 (1N4152) |
| A1CR1946 | 152-0141-02 | | | SEMICOND DVC,DI:SW,S1,30V,150MA,30V,DO-35 | 03508 | DA2527 (1N4152) |
| A1CR1947 | 152-0141-02 | | | SEMICOND DVC,DI:SW,S1,30V,150MA,30V,DO-35 | 03508 | DA2527 (1N4152) |
| A1CR1948 | 152-0141-02 | | | SEMICOND DVC,DI:SW,S1,30V,150MA,30V,DO-35 | 03508 | DA2527 (1N4152) |
| A1CR1963 | 152-0141-02 | | | SEMICOND DVC,DI:SW,S1,30V,150MA,30V,DO-35 | 03508 | DA2527 (1N4152) |
| A1E1946 | 276-0532-00 | B042761 | | SHLD BEAD,ELEC:FERRITE | 02114 | 56-590-65/4A6 |
| A1J1917 | 131-1003-00 | | | CONN,RCPT,ELEC:CKT BD MT,3 PRONG | 80009 | 131-1003-00 |
| A1J1924 | 131-1003-00 | | | CONN,RCPT,ELEC:CKT BD MT,3 PRONG | 80009 | 131-1003-00 |
| A1J1943 | 131-1003-00 | | | CONN,RCPT,ELEC:CKT BD MT,3 PRONG | 80009 | 131-1003-00 |
| A1J1992 | 131-1003-00 | | | CONN,RCPT,ELEC:CKT BD MT,3 PRONG | 80009 | 131-1003-00 |
| A1L1995 | 108-0245-00 | | | CHOKE,RF:FIXED,3.9UH | 76493 | B6310-1 |
| A1L1997 | 108-0245-00 | | | CHOKE,RF:FIXED,3.9UH | 76493 | B6310-1 |
| A1P1900 | 131-0589-00 | | | TERMINAL,PIN:0.46 L X 0.025 SQ PH BRZ (QUANTITY OF 8) | 22526 | 48283-029 |
| A1P1904 | 131-0608-00 | | | TERMINAL,PIN:0.365 L X 0.025 BRZ GLD PL (QUANTITY OF 8) | 22526 | 48283-036 |
| A1P1910 | 131-0608-00 | | | TERMINAL,PIN:0.365 L X 0.025 BRZ GLD PL (QUANTITY OF 4) | 22526 | 48283-036 |

| Component No. | Tektronix Part No. | Serial/Assembly No. Effective | Discount | Name & Description | Mfr. Code | Mfr. Part No. |
|---------------|--------------------|-------------------------------|----------|---|-----------|-----------------|
| A1P1917 | 131-0608-00 | | | TERMINAL,PIN:0.365 L X 0.025 BRZ GLD PL (QUANTITY OF 5) | 22526 | 48283-036 |
| A1Q1908 | 151-0508-00 | | | TRANSISTOR:UJT,SI,TO-98 | 03508 | X13T520 |
| A1Q1910 | 151-0341-00 | | | TRANSISTOR:NPN,SI,TO-106 | 04713 | SPS6919 |
| A1Q1916 | 151-0192-00 | | | TRANSISTOR:NPN,SI,TO-92 | 04713 | SPS8801 |
| A1Q1928 | 151-0271-00 | | | TRANSISTOR:PNP,SI,TO-92 | 04713 | SPS8236 |
| A1Q1934 | 151-0223-00 | | | TRANSISTOR:NPN,SI,625MW,TO-92 | 80009 | 151-0223-00 |
| A1Q1938 | 151-0223-00 | | | TRANSISTOR:NPN,SI,625MW,TD-92 | 80009 | 151-0223-00 |
| A1Q1942 | 151-0301-00 | | | TRANSISTOR:PNP,SI,TO-18 | 80009 | 151-0301-00 |
| A1Q1943 | 151-0198-00 | | | TRANSISTOR:SELECTED | 80009 | 151-0198-00 |
| A1Q1946 | 151-0198-00 | | | TRANSISTOR:SELECTED | 80009 | 151-0198-00 |
| A1Q1956 | 151-0302-00 | | | TRANSISTOR:NPN,SI,TO-18 | 04713 | ST899 |
| A1R301 | 303-0301-00 | | | RES,FXD,CMPSN:300 OHM,5%,1W | 01121 | GB3015 |
| A1R1900 | 311-1587-00 | | | RES,VAR,NONNW:PNL,10K OHM,1W,W/SW | 01121 | 12M435 |
| A1R1901 | 315-0106-00 | | | RES,FXD,FILM:10M OHM,5%,0.25W | 01121 | CB1065 |
| A1R1902 | 311-1319-00 | | | RES,VAR,NONNW:TRMR,10K OHM,0.5W | 32997 | 3006P-W84-103 |
| A1R1903 | 315-0101-00 | | | RES,FXD,FILM:100 OHM,5%,0.25W | 57668 | NTR25J-E 100E |
| A1R1905 | 315-0103-00 | | | RES,FXD,FILM:10K OHM,5%,0.25W | 19701 | 5043CX10K00J |
| A1R1906 | 315-0103-00 | | | RES,FXD,FILM:10K OHM,5%,0.25W | 19701 | 5043CX10K00J |
| A1R1908 | 315-0512-00 | | | RES,FXD,FILM:5.1K OHM,5%,0.25W | 57668 | NTR25J-E05K1 |
| A1R1909 | 315-0244-00 | | | RES,FXD,FILM:240K OHM,5%,0.25W | 19701 | 5043CX240K0J |
| A1R1910 | 315-0104-00 | | | RES,FXD,FILM:100K OHM,5%,0.25W | 57668 | NTR25J-E100K |
| A1R1911 | 321-0143-00 | | | RES,FXD,FILM:301 OHM,1%,0.125W,TC=TO | 07716 | CEAD301R0F |
| A1R1914 | 315-0471-00 | B010100 | B042057 | RES,FXD,FILM:470 OHM,5%,0.25W | 57668 | NTR25J-E470E |
| A1R1914 | 315-0201-00 | B042058 | | RES,FXD,FILM:200 OHM,5%,0.25W | 57668 | NTR25J-E200E |
| A1R1915 | 315-0104-00 | | | RES,FXD,FILM:100K OHM,5%,0.25W | 57668 | NTR25J-E100K |
| A1R1916 | 315-0512-00 | | | RES,FXD,FILM:5.1K OHM,5%,0.25W | 57668 | NTR25J-E05K1 |
| A1R1917 | 315-0153-00 | | | RES,FXD,FILM:15K OHM,5%,0.25W | 19701 | 5043CX15K00J |
| A1R1918 | 315-0106-00 | | | RES,FXD,FILM:10M OHM,5%,0.25W | 01121 | CB1065 |
| A1R1919 | 315-0105-00 | | | RES,FXD,FILM:1M OHM,5%,0.25W | 19701 | 5043CX1M000J |
| A1R1920 | 315-0101-00 | | | RES,FXD,FILM:100 OHM,5%,0.25W | 57668 | NTR25J-E 100E |
| A1R1921 | 315-0105-00 | | | RES,FXD,FILM:1M OHM,5%,0.25W | 19701 | 5043CX1M000J |
| A1R1922 | 315-0202-00 | | | RES,FXD,FILM:2K OHM,5%,0.25W | 57668 | NTR25J-E 2K |
| A1R1923 | 311-1339-00 | | | RES,VAR,NONNW:TRMR,5K OHM,0.75W | 02111 | 43P502T672 |
| A1R1924 | 311-1588-00 | | | RES,VAR,NONNW:PNL,5K OHM,1W,W/SW | 01121 | 20M718 |
| A1R1925 | 315-0202-00 | | | RES,FXD,FILM:2K OHM,5%,0.25W | 57668 | NTR25J-E 2K |
| A1R1926 | 315-0101-00 | | | RES,FXD,FILM:100 OHM,5%,0.25W | 57668 | NTR25J-E 100E |
| A1R1927 | 321-0226-00 | | | RES,FXD,FILM:2.21K OHM,1%,0.125W,TC=TO | 01121 | RNK2211F |
| A1R1928 | 321-0180-00 | | | RES,FXD,FILM:732 OHM,1%,0.125W,TC=TO | 07716 | CEAD732R0F |
| A1R1929 | 321-0190-00 | | | RES,FXD,FILM:931 OHM,1%,0.125W,TC=TO | 19701 | 5043ED931R0F |
| A1R1930 | 315-0431-00 | | | RES,FXD,FILM:430 OHM,5%,0.25W | 19701 | 5043CX430R0J |
| A1R1931 | 315-0510-00 | | | RES,FXD,FILM:51 OHM,5%,0.25W | 19701 | 5043CX51R00J |
| A1R1932 | 323-0189-00 | | | RES,FXD,FILM:909 OHM,1%,0.5W,TC=TO | 19701 | 5053RD909R0F |
| A1R1933 | 315-0101-00 | | | RES,FXD,FILM:100 OHM,5%,0.25W | 57668 | NTR25J-E 100E |
| A1R1934 | 315-0301-00 | | | RES,FXD,FILM:300 OHM,5%,0.25W | 57668 | NTR25J-E300E |
| A1R1935 | 315-0473-00 | | | RES,FXD,FILM:47K OHM,5%,0.25W | 57668 | NTR25J-E47K0 |
| A1R1936 | 315-0101-00 | | | RES,FXD,FILM:100 OHM,5%,0.25W | 57668 | NTR25J-E 100E |
| A1R1937 | 315-0123-00 | | | RES,FXD,FILM:12K OHM,5%,0.25W | 57668 | NTR25J-E12K0 |
| A1R1938 | 315-0331-00 | | | RES,FXD,FILM:330 OHM,5%,0.25W | 57668 | NTR25J-E330E |
| A1R1940 | 315-0510-00 | | | RES,FXD,FILM:51 OHM,5%,0.25W | 19701 | 5043CX51R00J |
| A1R1941 | 315-0510-00 | | | RES,FXD,FILM:51 OHM,5%,0.25W | 19701 | 5043CX51R00J |
| A1R1942 | 315-0204-00 | | | RES,FXD,FILM:200K OHM,5%,0.25W | 19701 | 5043CX200K0J |
| A1R1943 | 321-0097-00 | | | RES,FXD,FILM:100 OHM,1%,0.125W,TC=TO | 91637 | CMF551166100R0F |
| A1R1944 | 321-0262-00 | | | RES,FXD,FILM:5.23K OHM,1,0.125W,TC=TO | 19701 | 5033ED5K230F |
| A1R1945 | 301-0102-00 | | | RES,FXD,CMPSN:1K OHM,5%,0.50W | 19701 | 5053CX1K000J |
| A1R1946 | 321-0097-00 | | | RES,FXD,FILM:100 OHM,1%,0.125W,TC=TO | 91637 | CMF551166100R0F |
| A1R1948 | 321-0190-00 | | | RES,FXD,FILM:931 OHM,1%,0.125W,TC=TO | 19701 | 5043ED931R0F |
| A1R1950 | 315-0223-00 | | | RES,FXD,FILM:22K OHM,5%,0.25W | 19701 | 5043CX22K00J92U |

Replaceable Electrical Parts - 7904A

| Component No. | Tektronix Part No. | Serial/Assembly No. Effective Dscont | Name & Description | Mfr. Code | Mfr. Part No. |
|---------------|--------------------|--------------------------------------|---|-----------|-----------------|
| A1R1951 | 321-0481-00 | | RES,FXD,FILM:1M OHM,1%,0.125W,TC=TO | 19701 | 5043ED1M000F |
| A1R1952 | 321-0289-00 | | RES,FXD,FILM:10.0K OHM,1%,0.125W,TC=TO | 19701 | 5033ED10K00F |
| A1R1953 | 315-0104-00 | | RES,FXD,FILM:100K OHM,5%,0.25W | 57668 | NTR25J-E100K |
| A1R1954 | 315-0104-00 | | RES,FXD,FILM:100K OHM,5%,0.25W | 57668 | NTR25J-E100K |
| A1R1955 | 315-0103-00 | | RES,FXD,FILM:10K OHM,5%,0.25W | 19701 | 5043CX10K00J |
| A1R1956 | 315-0243-00 | | RES,FXD,FILM:24K OHM,5%,0.25W | 57668 | NTR25J-E24K0 |
| A1R1957 | 315-0821-00 | | RES,FXD,FILM:820 OHM,5%,0.25W | 19701 | 5043CX820R0J |
| A1R1960 | 321-0260-00 | | RES,FXD,FILM:4.99K OHM,1%,0.125W,TC=TO | 19701 | 5033ED4K990F |
| A1R1963 | 321-0283-00 | | RES,FXD,FILM:8.66K OHM,1%,0.125W,TC=TO | 19701 | 5043ED8K660F |
| A1R1964 | 321-0205-00 | | RES,FXD,FILM:1.33K OHM,1%,0.125W,TC=TO | 19701 | 5033ED1K330F |
| A1R1965 | 321-0260-00 | | RES,FXD,FILM:4.99K OHM,1%,0.125W,TC=TO | 19701 | 5033ED4K990F |
| A1R1966 | 315-0103-00 | | RES,FXD,FILM:10K OHM,5%,0.25W | 19701 | 5043CX10K00J |
| A1S1900 | ----- | | (PART OF A1R1900) | | |
| A1S1905 | 260-1380-00 | | SWITCH,PUSH:2 BUTTON,2 POLE,STORAGE LOGIC | 59821 | 2KBM020000619 |
| A1S1910 | ----- | | (PART OF A1S1905) | | |
| A1S1915 | 260-1380-00 | | SWITCH,PUSH:2 BUTTON,2 POLE,STORAGE LOGIC | 59821 | 2KBM020000619 |
| A1S1920 | ----- | | (PART OF A1S1915) | | |
| A1S1924 | ----- | | (PART OF A1R1924) | | |
| A1S1930 | 260-1208-00 | | SWITCH,PUSH:DPDT,28VDC,PUSH-PUSH | 31918 | ORDER BY DESCR |
| A1S1940 | 260-1208-00 | | SWITCH,PUSH:DPDT,28VDC,PUSH-PUSH | 31918 | ORDER BY DESCR |
| A1TP1908 | 214-0579-00 | | TERM,TEST POINT:BRS CD PL | 80009 | 214-0579-00 |
| A1TP1925 | 214-0579-00 | | TERM,TEST POINT:BRS CD PL | 80009 | 214-0579-00 |
| A1TP1952 | 214-0579-00 | | TERM,TEST POINT:BRS CD PL | 80009 | 214-0579-00 |
| A1TP1958 | 214-0579-00 | | TERM,TEST POINT:BRS CD PL | 80009 | 214-0579-00 |
| A1U1952 | 156-0686-00 | | MICROCKT,LINEAR:MOS,OPNL AMPL | 02735 | CA3130S |
| A1U1958 | 156-0067-00 | | MICROCKT,LINEAR:BIPOLAR,OPNL AMPL | 04713 | MC1741CP1 |
| A1VR1910 | 152-0280-00 | | SEMICON DVC,DI:ZEN,SI,6.2V,5%,0.4W,DO-7 OR DO-35 | 04713 | 1N753A |
| A2 | 670-5227-01 | | CIRCUIT BD ASSY:DISPLAY CONTROLLER | 80009 | 670-5227-01 |
| A2CR2009 | 152-0141-02 | | SEMICON DVC,DI:SW,SI,30V,150MA,30V,DO-35 | 03508 | DA2527 (1N4152) |
| A2CR2019 | 152-0141-02 | | SEMICON DVC,DI:SW,SI,30V,150MA,30V,DO-35 | 03508 | DA2527 (1N4152) |
| A2P2003 | 131-0608-00 | | TERMINAL,PIN:0.365 L X 0.025 BRZ GLD PL (QUANTITY OF 4) | 22526 | 48283-036 |
| A2P2005 | 131-0608-00 | | TERMINAL,PIN:0.365 L X 0.025 BRZ GLD PL (QUANTITY OF 7) | 22526 | 48283-036 |
| A2P2006 | 131-0608-00 | | TERMINAL,PIN:0.365 L X 0.025 BRZ GLD PL (QUANTITY OF 9) | 22526 | 48283-036 |
| A2R2005 | 311-1973-00 | | RES,VAR,NONW:PNL,2.5M OHM,20%,0.75 W | 01121 | 73M1G040L255M |
| A2R2007 | 315-0622-00 | | RES,FXD,FILM:6.2K OHM,5%,0.25W | 19701 | 5043CX6K200J |
| A2R2008 | 315-0303-00 | | RES,FXD,FILM:30K OHM,5%,0.25W | 19701 | 5043CX30K00J |
| A2R2009 | 321-0193-00 | | RES,FXD,FILM:1K OHM,1%,0.125W,TC=TO | 19701 | 5033ED1K000F |
| A2R2010 | 311-1375-00 | | RES,VAR,NONW:PNL,10K OHM,1W | 01121 | 73M1G040L103M |
| A2R2015 | 311-1372-00 | | RES,VAR,NONW:PNL,100K OHM,0.5W | 01121 | 73U1G040L104M |
| A2R2016 | 315-0154-00 | | RES,FXD,FILM:150K OHM,5%,0.25W | 57668 | NTR25J-E150K |
| A2R2017 | 315-0622-00 | | RES,FXD,FILM:6.2K OHM,5%,0.25W | 19701 | 5043CX6K200J |
| A2R2018 | 315-0303-00 | | RES,FXD,FILM:30K OHM,5%,0.25W | 19701 | 5043CX30K00J |
| A2R2019 | 321-0193-00 | | RES,FXD,FILM:1K OHM,1%,0.125W,TC=TO | 19701 | 5033ED1K000F |
| A2R2020 | 311-1375-00 | | RES,VAR,NONW:PNL,10K OHM,1W | 01121 | 73M1G040L103M |
| A2R2025 | 311-1372-00 | | RES,VAR,NONW:PNL,100K OHM,0.5W | 01121 | 73U1G040L104M |
| A2R2035 | 311-1972-00 | | RES,VAR,NONW:PNL,2K OHM,10%,2.0 W | 01121 | 70N1G100L202W |
| A2S2005 | 260-1208-00 | | SWITCH,PUSH:DPDT,28VDC,PUSH-PUSH | 31918 | ORDER BY OESCR |
| A3 | 670-4778-01 | | CIRCUIT BD ASSY:TRIGGER LIGHT | 80009 | 670-4778-01 |
| A3DS342 | 150-0048-01 | | LAMP,INCAND:5V,0.06A,#683,AGED & SEL | 58854 | 683AS15 |
| A3DS345 | 150-0048-01 | | LAMP,INCAND:5V,0.06A,#683,AGED & SEL | 58854 | 683AS15 |
| A3DS346 | 150-0048-01 | | LAMP,INCAND:5V,0.06A,#683,AGED & SEL | 58854 | 683AS15 |
| A3P346 | 131-0608-00 | | TERMINAL,PIN:0.365 L X 0.025 BRZ GLD PL (QUANTITY OF 4) | 22526 | 48283-036 |
| A4 | 670-4778-01 | | CIRCUIT BD ASSY:TRIGGER LIGHT | 80009 | 670-4778-01 |

| Component No. | Tektronix Part No. | Serial/Assembly No. Effective Dscnt | Name & Description | Mfr. Code | Mfr. Part No. |
|---------------|--------------------|-------------------------------------|--|-----------|------------------|
| A4DS362 | 150-0048-01 | | LAMP, INCAND:5V, 0.06A, #683, AGED & SEL | 58854 | 683AS15 |
| A4DS365 | 150-0048-01 | | LAMP, INCAND:5V, 0.06A, #683, AGED & SEL | 58854 | 683AS15 |
| A4DS366 | 150-0048-01 | | LAMP, INCAND:5V, 0.06A, #683, AGED & SEL | 58854 | 683AS15 |
| A4P366 | 131-0608-00 | | TERMINAL, PIN:0.365 L X 0.025 BRZ GLD PL | 22526 | 48283-036 |
| A5 | 670-4773-04 | | CIRCUIT BD ASSY:MODE SW | 80009 | 670-4773-04 |
| A5C324 | 283-0002-00 | | CAP, FXD, CER DI:0.01UF, +80-20%, 500V | 59821 | D103Z40Z5JULADEG |
| A5C325 | 283-0115-00 | | CAP, FXD, CER DI:47PF, 5%, 200V | 59821 | 2DDT60K470J |
| A5C326 | 283-0002-00 | | CAP, FXD, CER DI:0.01UF, +80-20%, 500V | 59821 | D103Z40Z5JULADEG |
| A5C376 | 285-1006-00 | | CAP, FXD, PLASTIC:0.22UF, 2%, 50V | TK2038 | 285-1006-00 |
| A5C384 | 283-0115-00 | | CAP, FXD, CER DI:47PF, 5%, 200V | 59821 | 2DDT60K470J |
| A5C386 | 283-0115-00 | | CAP, FXD, CER DI:47PF, 5%, 200V | 59821 | 2DDT60K470J |
| A5CR342 | 152-0141-02 | | SEMICOND DVC, DI:SW, SI, 30V, 150MA, 30V, DO-35 | 03508 | DA2527 (1N4152) |
| A5CR362 | 152-0141-02 | | SEMICOND DVC, DI:SW, SI, 30V, 150MA, 30V, DO-35 | 03508 | DA2527 (1N4152) |
| A5CR386 | 152-0141-02 | | SEMICOND DVC, DI:SW, SI, 30V, 150MA, 30V, DO-35 | 03508 | DA2527 (1N4152) |
| A5J301 | 131-1003-00 | | CONN, RCPT, ELEC:CKT BD MT, 3 PRONG | 80009 | 131-1003-00 |
| A5J392 | 131-1003-00 | | CONN, RCPT, ELEC:CKT BD MT, 3 PRONG | 80009 | 131-1003-00 |
| A5P302 | 131-0608-00 | | TERMINAL, PIN:0.365 L X 0.025 BRZ GLD PL (QUANTITY OF 10) | 22526 | 48283-036 |
| A5P303 | 131-0608-00 | | TERMINAL, PIN:0.365 L X 0.025 BRZ GLD PL (QUANTITY OF 10) | 22526 | 48283-036 |
| A5P304 | 131-0608-00 | | TERMINAL, PIN:0.365 L X 0.025 BRZ GLD PL (QUANTITY OF 5) | 22526 | 48283-036 |
| A5P305 | 131-0608-00 | | TERMINAL, PIN:0.365 L X 0.025 BRZ GLD PL (QUANTITY OF 7) | 22526 | 48283-036 |
| A5P306 | 131-0608-00 | | TERMINAL, PIN:0.365 L X 0.025 BRZ GLD PL (QUANTITY OF 8) | 22526 | 48283-036 |
| A5P308 | 131-0608-00 | | TERMINAL, PIN:0.365 L X 0.025 BRZ GLD PL (QUANTITY OF 2) | 22526 | 48283-036 |
| A5P309 | 131-0608-00 | | TERMINAL, PIN:0.365 L X 0.025 BRZ GLD PL (QUANTITY OF 10) | 22526 | 48283-036 |
| A5P310 | 131-0608-00 | | TERMINAL, PIN:0.365 L X 0.025 BRZ GLD PL (QUANTITY OF 4) | 22526 | 48283-036 |
| A5P318 | 131-0608-00 | | TERMINAL, PIN:0.365 L X 0.025 BRZ GLD PL (QUANTITY OF 5) | 22526 | 48283-036 |
| A5Q342 | 151-0302-00 | | TRANSISTOR:NPN, SI, TO-18 | 04713 | ST899 |
| A5Q346 | 151-0302-00 | | TRANSISTOR:NPN, SI, TO-18 | 04713 | ST899 |
| A5Q362 | 151-0302-00 | | TRANSISTOR:NPN, SI, TO-18 | 04713 | ST899 |
| A5Q366 | 151-0302-00 | | TRANSISTOR:NPN, SI, TO-18 | 04713 | ST899 |
| A5Q376 | 151-0192-00 | | TRANSISTOR:NPN, SI, TO-92 | 04713 | SPS8801 |
| A5Q382 | 151-0192-00 | | TRANSISTOR:NPN, SI, TO-92 | 04713 | SPS8801 |
| A5Q384 | 151-0342-00 | | TRANSISTOR:PMP, SI, TO-92 | 07263 | S035928 |
| A5R324 | 315-0152-00 | | RES, FXD, FILM:1.5K OHM, 5%, 0.25W | 57668 | NTR25J-E01K5 |
| A5R325 | 311-1373-00 | | RES, VAR, NONWV:PVL, 5K OHM, 1W | 32997 | 81C10-E20-8A0344 |
| A5R326 | 315-0152-00 | | RES, FXD, FILM:1.5K OHM, 5%, 0.25W | 57668 | NTR25J-E01K5 |
| A5R341 | 307-0109-00 | | RES, FXD, CMPSN:8.2 OHM, 5%, 0.25W | 80009 | 307-0109-00 |
| A5R342 | 315-0202-00 | | RES, FXD, FILM:2K OHM, 5%, 0.25W | 57668 | NTR25J-E 2K |
| A5R343 | 315-0162-00 | | RES, FXD, FILM:1.6K OHM, 5%, 0.25W | 19701 | 5043CX1K600J |
| A5R345 | 307-0109-00 | | RES, FXD, CMPSN:8.2 OHM, 5%, 0.25W | 80009 | 307-0109-00 |
| A5R346 | 315-0202-00 | | RES, FXD, FILM:2K OHM, 5%, 0.25W | 57668 | NTR25J-E 2K |
| A5R347 | 307-0109-00 | | RES, FXD, CMPSN:8.2 OHM, 5%, 0.25W | 80009 | 307-0109-00 |
| A5R361 | 307-0109-00 | | RES, FXD, CMPSN:8.2 OHM, 5%, 0.25W | 80009 | 307-0109-00 |
| A5R362 | 315-0202-00 | | RES, FXD, FILM:2K OHM, 5%, 0.25W | 57668 | NTR25J-E 2K |
| A5R363 | 315-0162-00 | | RES, FXD, FILM:1.6K OHM, 5%, 0.25W | 19701 | 5043CX1K600J |
| A5R365 | 307-0109-00 | | RES, FXD, CMPSN:8.2 OHM, 5%, 0.25W | 80009 | 307-0109-00 |
| A5R366 | 315-0202-00 | | RES, FXD, FILM:2K OHM, 5%, 0.25W | 57668 | NTR25J-E 2K |
| A5R367 | 307-0109-00 | | RES, FXD, CMPSN:8.2 OHM, 5%, 0.25W | 80009 | 307-0109-00 |
| A5R368 | 315-0512-00 | | RES, FXD, FILM:5.1K OHM, 5%, 0.25W | 57668 | NTR25J-E05K1 |
| A5R372 | 315-0823-00 | | RES, FXD, FILM:82K OHM, 5%, 0.25W | 57668 | NTR25J-E82K |
| A5R373 | 321-0258-00 | | RES, FXD, FILM:4.75K OHM, 1%, 0.125W, TC=TO | 19701 | 5033D4K750F |

Replaceable Electrical Parts - 7904A

| Component No. | Tektronix Part No. | Serial/Assembly No. Effective | Discount | Name & Description | Mfr. Code | Mfr. Part No. |
|---------------|--------------------|-------------------------------|----------|---|-----------|------------------|
| A5R374 | 321-0822-06 | | | RES,FXD,FILM:1.76K OHM,0.25%,0.125W,TC=T9 | 19701 | 5033RE1K76DC |
| A5R375 | 311-1566-00 | | | RES,VAR,NONNW:TRMR,200 OHM,0.5W | 32997 | 3352T-1-201 |
| A5R376 | 321-0321-07 | | | RES,FXD,FILM:21.5K OHM,0.1%,0.125W,TC=T9 | 19701 | 5033RE21K50B |
| A5R380 | 315-0362-00 | | | RES,FXD,FILM:3.6K OHM,5%,0.25W | 19701 | 5043CX3K600J |
| A5R381 | 321-0321-07 | | | RES,FXD,FILM:21.5K OHM,0.1%,0.125W,TC=T9 | 19701 | 5033RE21K50B |
| A5R382 | 315-0123-00 | | | RES,FXD,FILM:12K OHM,5%,0.25W | 57668 | NTR25J-E12KO |
| A5R383 | 321-0164-00 | | | RES,FXD,FILM:499 OHM,1%,0.125W,TC=T0 | 19701 | 5033ED499ROF |
| A5R384 | 308-0307-00 | | | RES,FXD,WW:5K OHM,1%,3W | 00213 | 1240S-5000-1 |
| A5R385 | 311-1225-00 | | | RES,VAR,NONNW:TRMR,1K OHM,0.5W | 32997 | 3386F-T04-102 |
| A5R387 | 321-1611-07 | | | RES,FXD,FILM:550 OHM,0.1%,0.125W,TC=T9 | 19701 | 5033RE550ROB |
| A5R389 | 321-1008-04 | | | RES,FXD,FILM:12.0 OHM,0.1%,0.125W,TC=T2 | 57668 | CRB14 BYE 12 OHM |
| A5R392 | 321-1612-07 | | | RES,FXD,FILM:4.455K OHM,0.1%,0.125W,TC=T9 | 19701 | 5033RE4K455B |
| A5R393 | 321-1611-07 | | | RES,FXD,FILM:550 OHM,0.1%,0.125W,TC=T9 | 19701 | 5033RE550ROB |
| A5R394 | 321-1612-07 | | | RES,FXD,FILM:4.455K OHM,0.1%,0.125W,TC=T9 | 19701 | 5033RE4K455B |
| A5R395 | 321-1611-07 | | | RES,FXD,FILM:550 OHM,0.1%,0.125W,TC=T9 | 19701 | 5033RE550ROB |
| A5R396 | 321-1612-07 | | | RES,FXD,FILM:4.455K OHM,0.1%,0.125W,TC=T9 | 19701 | 5033RE4K455B |
| A5R397 | 321-0813-07 | | | RES,FXD,FILM:495 OHM,0.1%,0.125W,TC=T9 | 19701 | 5033RE495OB |
| A5S315 | 263-0021-02 | | | SWITCH PB ASSY:4 LATCH,7.5 MM,8 CONTACTS | 80009 | 263-0021-02 |
| A5S325 | 263-0022-02 | | | SWITCH PB ASSY:5 LATCH,7.5 MM,10 CONTACTS | 80009 | 263-0022-02 |
| A5S345 | 263-0013-10 | | | SWITCH PB ASSY:3 LATCH,10 MM,W/3 CONTACTS | 80009 | 263-0013-10 |
| A5S365 | 263-0013-10 | | | SWITCH PB ASSY:3 LATCH,10 MM,W/3 CONTACTS | 80009 | 263-0013-10 |
| A5S395 | 263-0013-11 | | | SWITCH PB ASSY:3 LATCH,10 MM,5 CONTACTS | 80009 | 263-0013-11 |
| A5TP301 | 214-0579-00 | | | TERM,TEST POINT:BRS CD PL | 80009 | 214-0579-00 |
| A5TP362 | 214-0579-00 | | | TERM,TEST POINT:BRS CD PL | 80009 | 214-0579-00 |
| A5TP363 | 214-0579-00 | | | TERM,TEST POINT:BRS CD PL | 80009 | 214-0579-00 |
| A5TP365 | 214-0579-00 | | | TERM,TEST POINT:BRS CD PL | 80009 | 214-0579-00 |
| A5TP366 | 214-0579-00 | | | TERM,TEST POINT:BRS CD PL | 80009 | 214-0579-00 |
| A5TP367 | 214-0579-00 | | | TERM,TEST POINT:BRS CD PL | 80009 | 214-0579-00 |
| A5TP368 | 214-0579-00 | | | TERM,TEST POINT:BRS CD PL | 80009 | 214-0579-00 |
| A5TP369 | 214-0579-00 | | | TERM,TEST POINT:BRS CD PL | 80009 | 214-0579-00 |
| A5U352 | 156-0384-02 | | | MICROCKT,DGTL:QUAD 2-INP NAND GATE,SCRN | 07263 | 74LS03PCQR |
| A5U362 | 156-0386-02 | | | MICROCKT,DGTL:TRIPLE 3-INP NAND GATE,SCRN | 07263 | 74LS10PCQR |
| A5U364 | 156-0382-02 | | | MICROCKT,DGTL:QUAD 2 INP NAND GATE BURN | 1B324 | N74LS00NB |
| A5U366 | 156-0382-02 | | | MICROCKT,DGTL:QUAD 2 INP NAND GATE BURN | 1B324 | N74LS00NB |
| A5U368 | 156-0722-02 | | | MICROCKT,DGTL:TRIPLE 3-INP NAND W/OC OUT | 01295 | SN74LS12NP3 |
| A6 | 670-4775-00 | B010100 | B010939 | CIRCUIT BD ASSY:MAIN INTERFACE | 80009 | 670-4775-00 |
| A6 | 670-4775-01 | B010940 | B031870 | CIRCUIT BD ASSY:MAIN INTERFACE | 80009 | 670-4775-01 |
| A6 | 670-4775-02 | B031871 | | CIRCUIT BD ASSY:MAIN INTFC | 80009 | 670-4775-02 |
| A6C2 | 290-0747-00 | B010100 | B031870 | CAP,FXD,ELCTLT:100UF,+50-20%,25WVDC | 54473 | ECE-B25V100L |
| A6C2 | 290-0966-00 | B031871 | | CAP,FXD,ELCTLT:220UF,+50-20%,25V | 55680 | TLB1E221TCAANA |
| A6C3 | 285-0674-00 | | | CAP,FXD,PLASTIC:0.01UF,10%,100V | 84411 | TEK270-10391 |
| A6C4 | 290-0747-00 | | | CAP,FXD,ELCTLT:100UF,+50-20%,25WVDC | 54473 | ECE-B25V100L |
| A6C5 | 285-0674-00 | | | CAP,FXD,PLASTIC:0.01UF,10%,100V | 84411 | TEK270-10391 |
| A6C6 | 290-0194-00 | B010100 | B010939 | CAP,FXD,ELCTLT:10UF,+50-10%,100V | 00853 | 556DC100T100B |
| A6C6 | 290-0969-00 | B010940 | | CAP,FXD,ELCTLT:22UF,+50-10%,100V | 55680 | TLB2A220TAAANA |
| A6C8 | 290-0194-00 | B010100 | B010939 | CAP,FXD,ELCTLT:10UF,+50-10%,100V | 00853 | 556DC100T100B |
| A6C8 | 290-0969-00 | B010940 | | CAP,FXD,ELCTLT:22UF,+50-10%,100V | 55680 | TLB2A220TAAANA |
| A6C9 | 290-0747-00 | | | CAP,FXD,ELCTLT:100UF,+50-20%,25WVDC | 54473 | ECE-B25V100L |
| A6C71 | 281-0547-00 | | | CAP,FXD,CER DI:2.7PF,+/-0.25PF,500V | 52763 | 2R0PL2007 2P70CC |
| A6C85 | 283-0111-00 | | | CAP,FXD,CER DI:0.1UF,20%,50V | 04222 | SR305C104MAA |
| A6C87 | 283-0111-00 | | | CAP,FXD,CER DI:0.1UF,20%,50V | 04222 | SR305C104MAA |
| A6CR52 | 152-0141-02 | | | SEMICON DVC,DI:SW,SI,30V,150MA,30V,DO-35 | 03508 | DA2527 (1N4152) |
| A6CR71 | 152-0141-02 | | | SEMICON DVC,DI:SW,SI,30V,150MA,30V,DO-35 | 03508 | DA2527 (1N4152) |
| A6CR81 | 152-0141-02 | | | SEMICON DVC,DI:SW,SI,30V,150MA,30V,DO-35 | 03508 | DA2527 (1N4152) |
| A6CR82 | 152-0141-02 | | | SEMICON DVC,DI:SW,SI,30V,150MA,30V,DO-35 | 03508 | DA2527 (1N4152) |
| A6CR83 | 152-0141-02 | | | SEMICON DVC,DI:SW,SI,30V,150MA,30V,DO-35 | 03508 | DA2527 (1N4152) |
| A6CR86 | 152-0141-02 | | | SEMICON DVC,DI:SW,SI,30V,150MA,30V,DO-35 | 03508 | DA2527 (1N4152) |
| A6CR88 | 152-0141-02 | | | SEMICON DVC,DI:SW,SI,30V,150MA,30V,DO-35 | 03508 | DA2527 (1N4152) |

| Component No. | Tektronix Part No. | Serial/Assembly No. Effective Discont | Name & Description | Mfr. Code | Mfr. Part No. |
|---------------|--------------------|---------------------------------------|---|-----------|---------------|
| A6J1 | 131-0767-10 | | CONN,RCPT,ELEC:CKT BD,38/76 CONTACT | 80009 | 131-0767-10 |
| A6J2 | 131-0767-10 | | CONN,RCPT,ELEC:CKT BD,38/76 CONTACT | 80009 | 131-0767-10 |
| A6J3 | 131-0767-10 | | CONN,RCPT,ELEC:CKT BD,38/76 CONTACT | 80009 | 131-0767-10 |
| A6J4 | 131-0767-10 | | CONN,RCPT,ELEC:CKT BD,38/76 CONTACT | 80009 | 131-0767-10 |
| A6J38 | 131-1003-00 | | CONN,RCPT,ELEC:CKT BD MT,3 PRONG | 80009 | 131-1003-00 |
| A6J39 | 131-1003-00 | | CONN,RCPT,ELEC:CKT BD MT,3 PRONG | 80009 | 131-1003-00 |
| A6J71 | 131-1003-00 | | CONN,RCPT,ELEC:CKT BD MT,3 PRONG | 80009 | 131-1003-00 |
| A6J78 | 131-1003-00 | | CONN,RCPT,ELEC:CKT BD MT,3 PRONG | 80009 | 131-1003-00 |
| A6J90 | 131-1003-00 | | CONN,RCPT,ELEC:CKT BD MT,3 PRONG | 80009 | 131-1003-00 |
| A6J91 | 131-1003-00 | | CONN,RCPT,ELEC:CKT BD MT,3 PRONG | 80009 | 131-1003-00 |
| A6J92 | 131-1003-00 | | CONN,RCPT,ELEC:CKT BD MT,3 PRONG | 80009 | 131-1003-00 |
| A6J93 | 131-1003-00 | | CONN,RCPT,ELEC:CKT BD MT,3 PRONG | 80009 | 131-1003-00 |
| A6J94 | 131-1003-00 | | CONN,RCPT,ELEC:CKT BD MT,3 PRONG | 80009 | 131-1003-00 |
| A6J99 | 131-1003-00 | | CONN,RCPT,ELEC:CKT BD MT,3 PRONG | 80009 | 131-1003-00 |
| A6P2 | 131-0608-00 | | TERMINAL,PIN:0.365 L X 0.025 BRZ GLD PL (QUANTITY OF 10) | 22526 | 48283-036 |
| A6P3 | 131-0608-00 | | TERMINAL,PIN:0.365 L X 0.025 BRZ GLD PL (QUANTITY OF 10) | 22526 | 48283-036 |
| A6P9 | 131-0608-00 | | TERMINAL,PIN:0.365 L X 0.025 BRZ GLD PL (QUANTITY OF 10) | 22526 | 48283-036 |
| A6P65 | 131-0608-00 | | TERMINAL,PIN:0.365 L X 0.025 BRZ GLD PL (QUANTITY OF 10) | 22526 | 48283-036 |
| A6P66 | 131-0608-00 | | TERMINAL,PIN:0.365 L X 0.025 BRZ GLD PL (QUANTITY OF 10) | 22526 | 48283-036 |
| A6P67 | 131-0608-00 | | TERMINAL,PIN:0.365 L X 0.025 BRZ GLD PL (QUANTITY OF 10) | 22526 | 48283-036 |
| A6P79 | 131-0608-00 | | TERMINAL,PIN:0.365 L X 0.025 BRZ GLD PL (QUANTITY OF 5) | 22526 | 48283-036 |
| A6P80 | 131-0608-00 | | TERMINAL,PIN:0.365 L X 0.025 BRZ GLD PL (QUANTITY OF 7) | 22526 | 48283-036 |
| A6P82 | 131-0589-00 | | TERMINAL,PIN:0.46 L X 0.025 SQ PH BRZ (QUANTITY OF 10) | 22526 | 48283-029 |
| A6P83 | 131-0589-00 | | TERMINAL,PIN:0.46 L X 0.025 SQ PH BRZ (QUANTITY OF 8) | 22526 | 48283-029 |
| A6P84 | 131-0608-00 | | TERMINAL,PIN:0.365 L X 0.025 BRZ GLD PL (QUANTITY OF 5) | 22526 | 48283-036 |
| A6P85 | 131-0608-00 | | TERMINAL,PIN:0.365 L X 0.025 BRZ GLD PL (QUANTITY OF 9) | 22526 | 48283-036 |
| A6P87 | 131-0608-00 | | TERMINAL,PIN:0.365 L X 0.025 BRZ GLD PL (QUANTITY OF 7) | 22526 | 48283-036 |
| A6P89 | 131-0608-00 | | TERMINAL,PIN:0.365 L X 0.025 BRZ GLD PL (QUANTITY OF 10) | 22526 | 48283-036 |
| A6Q75 | 151-0192-00 | | TRANSISTOR:NPN,SI,T0-92 | 04713 | SPS8801 |
| A6R20 | 315-0470-00 | | RES,FXD,FILM:47 OHM,5%,0.25W | 57668 | NTR25J-E47E0 |
| A6R22 | 321-0260-00 | | RES,FXD,FILM:4.99K OHM,1%,0.125W,TC=TO | 19701 | 5033ED4K990F |
| A6R23 | 321-0260-00 | | RES,FXD,FILM:4.99K OHM,1%,0.125W,TC=TO | 19701 | 5033ED4K990F |
| A6R40 | 315-0470-00 | | RES,FXD,FILM:47 OHM,5%,0.25W | 57668 | NTR25J-E47E0 |
| A6R42 | 321-0260-00 | | RES,FXD,FILM:4.99K OHM,1%,0.125W,TC=TO | 19701 | 5033ED4K990F |
| A6R43 | 321-0260-00 | | RES,FXD,FILM:4.99K OHM,1%,0.125W,TC=TO | 19701 | 5033ED4K990F |
| A6R52 | 315-0472-00 | | RES,FXD,FILM:4.7K OHM,5%,0.25W | 57668 | NTR25J-E04K7 |
| A6R60 | 315-0470-00 | | RES,FXD,FILM:47 OHM,5%,0.25W | 57668 | NTR25J-E47E0 |
| A6R66 | 315-0302-00 | | RES,FXD,FILM:3K OHM,5%,0.25W | 57668 | NTR25J-E03K0 |
| A6R67 | 315-0202-00 | | RES,FXD,FILM:2K OHM,5%,0.25W | 57668 | NTR25J-E 2K |
| A6R71 | 315-0202-00 | | RES,FXD,FILM:2K OHM,5%,0.25W | 57668 | NTR25J-E 2K |
| A6R74 | 315-0202-00 | | RES,FXD,FILM:2K OHM,5%,0.25W | 57668 | NTR25J-E 2K |
| A6R75 | 315-0102-00 | | RES,FXD,FILM:1K OHM,5%,0.25W | 57668 | NTR25J-E01K0 |
| A6R80 | 315-0470-00 | | RES,FXD,FILM:47 OHM,5%,0.25W | 57668 | NTR25J-E47E0 |
| A6R83 | 315-0243-00 | | RES,FXD,FILM:24K OHM,5%,0.25W | 57668 | NTR25J-E24K0 |
| A6R85 | 315-0105-00 | | RES,FXD,FILM:1M OHM,5%,0.25W | 19701 | 5043CX1M000J |
| A6R86 | 315-0152-00 | | RES,FXD,FILM:1.5K OHM,5%,0.25W | 57668 | NTR25J-E01K5 |

Replaceable Electrical Parts - 7904A

| Component No. | Tektronix Part No. | Serial/Assembly No. Effective Dscont | Name & Description | Mfr. Code | Mfr. Part No. |
|---------------|--------------------|--------------------------------------|---|-----------|-----------------|
| A6R87 | 315-0103-00 | | RES,FXD,FILM:10K OHM,5%,0.25W | 19701 | 5043CX10K00J |
| A6R88 | 315-0152-00 | | RES,FXD,FILM:1.5K OHM,5%,0.25W | 57668 | NTR25J-E01K5 |
| A6R90 | 315-0202-00 | | RES,FXD,FILM:2K OHM,5%,0.25W | 57668 | NTR25J-E 2K |
| A6R91 | 315-0132-00 | | RES,FXD,FILM:1.3K OHM,5%,0.25W | 57668 | NTR25J-E01K3 |
| A6R92 | 315-0470-00 | | RES,FXD,FILM:47 OHM,5%,0.25W | 57668 | NTR25J-E47E0 |
| A6R93 | 321-0231-00 | | RES,FXD,FILM:2.49K OHM,1%,0.125W,TC=TO | 19701 | 5033ED2K49F |
| A6R94 | 323-0160-00 | | RES,FXD,FILM:453 OHM,1%,0.5W,TC=TO | 19701 | 5053RD453ROF |
| A6R95 | 321-0231-00 | | RES,FXD,FILM:2.49K OHM,1%,0.125W,TC=TO | 19701 | 5033ED2K49F |
| A6R97 | 315-0132-00 | | RES,FXD,FILM:1.3K OHM,5%,0.25W | 57668 | NTR25J-E01K3 |
| A6R99 | 315-0132-00 | | RES,FXD,FILM:1.3K OHM,5%,0.25W | 57668 | NTR25J-E01K3 |
| A7 | 670-8051-00 | | CIRCUIT BD ASSY:FRONT PANEL DISPLAY | 80009 | 670-8051-00 |
| A7P11 | 131-1149-00 | | CONTACT,ELEC:CKT BD EDGE,PH BRZ SIL PL (QUANTITY OF 2) | 80009 | 131-1149-00 |
| A7P12 | 131-1149-00 | | CONTACT,ELEC:CKT BD EDGE,PH BRZ SIL PL (QUANTITY OF 2) | 80009 | 131-1149-00 |
| A7P13 | 131-1149-00 | | CONTACT,ELEC:CKT BD EDGE,PH BRZ SIL PL (QUANTITY OF 2) | 80009 | 131-1149-00 |
| A8 | 670-8051-00 | | CIRCUIT BD ASSY:FRONT PANEL DISPLAY | 80009 | 670-8051-00 |
| A8P11 | 131-1149-00 | | CONTACT,ELEC:CKT BD EDGE,PH BRZ SIL PL (QUANTITY OF 2) | 80009 | 131-1149-00 |
| A8P12 | 131-1149-00 | | CONTACT,ELEC:CKT BD EDGE,PH BRZ SIL PL (QUANTITY OF 2) | 80009 | 131-1149-00 |
| A8P13 | 131-1149-00 | | CONTACT,ELEC:CKT BD EDGE,PH BRZ SIL PL (QUANTITY OF 2) | 80009 | 131-1149-00 |
| A9 | 670-8054-00 | | CIRCUIT BD ASSY:FRONT PANEL DISPLAY | 80009 | 670-8054-00 |
| A9P11 | 131-1149-00 | | CONTACT,ELEC:CKT BD EDGE,PH BRZ SIL PL (QUANTITY OF 2) | 80009 | 131-1149-00 |
| A9P12 | 131-1149-00 | | CONTACT,ELEC:CKT BD EDGE,PH BRZ SIL PL (QUANTITY OF 2) | 80009 | 131-1149-00 |
| A9P13 | 131-1149-00 | | CONTACT,ELEC:CKT BD EDGE,PH BRZ SIL PL (QUANTITY OF 2) | 80009 | 131-1149-00 |
| A9R81 | 317-0510-00 | | RES,FXD,CMPSN:51 OHM,5%,0.125W | 01121 | BB5105 |
| A9R82 | 317-0510-00 | | RES,FXD,CMPSN:51 OHM,5%,0.125W | 01121 | BB5105 |
| A10 | 670-8055-00 | | CIRCUIT BD ASSY:FRONT PANEL DISPLAY | 80009 | 670-8055-00 |
| A10P11 | 131-1149-00 | | CONTACT,ELEC:CKT BD EDGE,PH BRZ SIL PL (QUANTITY OF 2) | 80009 | 131-1149-00 |
| A10P12 | 131-1149-00 | | CONTACT,ELEC:CKT BD EDGE,PH BRZ SIL PL (QUANTITY OF 2) | 80009 | 131-1149-00 |
| A10P13 | 131-1149-00 | | CONTACT,ELEC:CKT BD EDGE,PH BRZ SIL PL (QUANTITY OF 2) | 80009 | 131-1149-00 |
| A10R61 | 317-0510-00 | | RES,FXD,CMPSN:51 OHM,5%,0.125W | 01121 | BB5105 |
| A10R62 | 317-0510-00 | | RES,FXD,CMPSN:51 OHM,5%,0.125W | 01121 | BB5105 |
| A11 | 670-4641-00 | | CIRCUIT BD ASSY:FAN | 80009 | 670-4641-00 |
| A11B20 | 147-0035-00 | | MOTOR,DC:BRUSHLESS,3000 RPM,10-15V | 25088 | 1A03001-0A |
| A11C10 | 290-0778-00 | | CAP,FXD,ELCTLT:1UF,20%,50V,NPLZD | 54473 | ECE-A50N1 |
| A11C13 | 290-0768-00 | | CAP,FXD,ELCTLT:10UF,+50-20%,100WVDC | 54473 | ECE-A100V10L |
| A11CR10 | 152-0141-02 | | SEMICON DVC,DI:SW,S1,30V,150MA,30V,DO-35 | 03508 | DA2527 (1N4152) |
| A11CR13 | 152-0141-02 | | SEMICON DVC,DI:SW,S1,30V,150MA,30V,DO-35 | 03508 | DA2527 (1N4152) |
| A11CR21 | 152-0141-02 | | SEMICON DVC,DI:SW,S1,30V,150MA,30V,DO-35 | 03508 | DA2527 (1N4152) |
| A11CR22 | 152-0141-02 | | SEMICON DVC,DI:SW,S1,30V,150MA,30V,DO-35 | 03508 | DA2527 (1N4152) |
| A11CR23 | 152-0141-02 | | SEMICON DVC,DI:SW,S1,30V,150MA,30V,DO-35 | 03508 | DA2527 (1N4152) |
| A11CR24 | 152-0141-02 | | SEMICON DVC,DI:SW,S1,30V,150MA,30V,DO-35 | 03508 | DA2527 (1N4152) |
| A11P80 | 131-0608-00 | | TERMINAL,PIN:0.365 L X 0.025 BRZ GLD PL (QUANTITY OF 2) | 22526 | 48283-036 |
| A11Q10 | 151-0301-00 | | TRANSISTOR:PNP,SI,TO-18 | 80009 | 151-0301-00 |
| A11Q20 | 156-0281-00 | | MICROCKT,LINEAR:4-XSTR,HIGH CUR ARRAY | 02735 | 89164 |
| A11R10 | 301-0271-00 | | RES,FXD,FILM:270 OHM,5%,0.5W | 19701 | 5053CX270ROJ |
| A11R11 | 315-0470-00 | | RES,FXD,FILM:47 OHM,5%,0.25W | 57668 | NTR25J-E47E0 |
| A11R13 | 301-0271-00 | | RES,FXD,FILM:270 OHM,5%,0.5W | 19701 | 5053CX270ROJ |
| A11R20 | 307-0059-00 | | RES,FXD,CMPSN:6.2 OHM,5%,0.5W | 01121 | EB62G5 |

| Component No. | Tektronix Part No. | Serial/Assembly No. Effective | Discount | Name & Description | Mfr. Code | Mfr. Part No. |
|---------------|--------------------|-------------------------------|----------|--|-----------|------------------|
| A11R24 | 321-0201-00 | | | RES, FXD, FILM: 1.21K OHM, 1%, 0.125W, TC=TO | 19701 | 5043ED1K210F |
| A11R25 | 321-0239-00 | | | RES, FXD, FILM: 3.01K OHM, 1%, 0.125W, TC=TO | 19701 | 5043ED3K010F |
| A11R27 | 321-0022-00 | | | RES, FXD, FILM: 16.5 OHM, 1%, 0.125W, TC=TO | 57668 | RB14FXE 16E5 |
| A12 | 620-0283-01 | | | POWER SUPPLY: LOW VOLTAGE (INCLUDES A12, A22, A23 ASSEMBLIES) | 80009 | 620-0283-01 |
| A12C16 | 290-0628-00 | | | CAP, FXD, ELCTLT: 950UF, +50-10%, 200V | 56289 | 36D7560 |
| A12C17 | 290-0628-00 | | | CAP, FXD, ELCTLT: 950UF, +50-10%, 200V | 56289 | 36D7560 |
| A12C37 | 285-0938-00 | | | CAP, FXD, PLASTIC: 0.03UF, 5%, 900V | 50558 | PA6-0738J |
| A12C154 | 290-0898-00 | | | CAP, FXD, ELCTLT: 2600UF, +75-10%, 35V | 56289 | 602DX262G035AA28 |
| A12F10 | 159-0017-00 | | | FUSE, CARTRIDGE: 3AG, 4A, 250V, FAST BLOW | 71400 | MTH-CW-4 |
| A12FL10 | 119-0420-00 | | | FILTER, RFI: 6A, 250VAC, 400HZ | 02777 | F-11935-6 |
| A12L37 | 108-0761-00 | | | COIL, RF: FIXED, 1MH | 54937 | 108-0761-00 |
| A12Q28 | 151-0656-00 | | | TRANSISTOR: DARLINGTON, NPN, SI, TO-220 | 02735 | 2N6044 |
| A12Q34 | 151-0632-00 | | | TRANSISTOR: NPN, SILICON, TO-220 | 04713 | MJE13007 |
| A12Q40 | 151-0632-00 | | | TRANSISTOR: NPN, SILICON, TO-220 | 04713 | MJE13007 |
| A12Q58 | 151-0657-00 | | | TRANSISTOR: DARLINGTON, PNP, SI, TO-220 | 04713 | SJE1973 |
| A12Q74 | 151-0656-00 | | | TRANSISTOR: DARLINGTON, NPN, SI, TO-220 | 02735 | 2N6044 |
| A12Q94 | 151-0657-00 | | | TRANSISTOR: DARLINGTON, PNP, SI, TO-220 | 04713 | SJE1973 |
| A12Q122 | 151-0349-00 | | | TRANSISTOR: NPN, SI, SELECTED, TO-127 | 04713 | SJE924 |
| A12Q126 | 151-0477-01 | | | TRANSISTOR: SCREENED | 80009 | 151-0477-01 |
| A12R6 | 303-0105-00 | | | RES, FXD, CMPSN: 1M OHM, 5%, 1W | 01121 | GB1055 |
| A12S12 | 260-1300-00 | | | SWITCH, SLIDE: DPDT, 3A, 125VAC | 82389 | 46206LFE |
| A12S99 | 260-0450-00 | | | SWITCH, SLIDE: DPTT, 0.5A, 125VAC | 82389 | 11D-1007 |
| A12T110 | 120-1183-00 | | | XFMR, PWR, STPDN: HIGH FREQUENCY | 75498 | 120-1183-00 |
| A12A1 | 670-5959-03 | B010100 | B031832 | CIRCUIT 8D ASSY: CONTROLLED RECTIFIER | 80009 | 670-5959-03 |
| A12A1 | 670-5959-04 | 8031833 | 8042342 | CIRCUIT 8D ASSY: CONTROLLED RECTIFIER | 80009 | 670-5959-04 |
| A12A1 | 670-5959-05 | 8042343 | | CIRCUIT 8D ASSY: CONTROLLER RECTIFIER (PART OF 620-0283-XX) | 80009 | 670-5959-05 |
| A12A1C52 | 283-0003-00 | B010100 | B031832 | CAP, FXD, CER DI: 0.01UF, +80-20%, 150V | 59821 | D103Z40Z5UJDC EX |
| A12A1C52 | 285-1340-00 | B031833 | | CAP, FXD, MTLZD: 0.01UF, 10%, 63V | 55112 | 185/0.01/K/63AAA |
| A12A1C54 | 290-0573-00 | | | CAP, FXD, ELCTLT: 2.7UF, 20%, 50V | 05397 | T368B275M050AS |
| A12A1C55 | 283-0028-00 | | | CAP, FXD, CER DI: 0.0022UF, 20%, 50V | 59660 | 0805585Y5S0222M |
| A12A1C64 | 290-0263-00 | | | CAP, FXD, ELCTLT: 2.7UF, 10%, 15V | 05397 | T320A275K015AS |
| A12A1C66 | 283-0003-00 | 8010100 | 8031832 | CAP, FXD, CER DI: 0.01UF, +80-20%, 150V | 59821 | D103Z40Z5UJDC EX |
| A12A1C66 | 285-1340-00 | 8031833 | | CAP, FXD, MTLZD: 0.01UF, 10%, 63V | 55112 | 185/0.01/K/63AAA |
| A12A1C67 | 290-0523-00 | B010100 | B031832 | CAP, FXD, ELCTLT: 2.2UF, 20%, 20V | 05397 | T368A225M020AS |
| A12A1C67 | 290-0573-00 | B031833 | | CAP, FXD, ELCTLT: 2.7UF, 20%, 50V | 05397 | T368B275M050AS |
| A12A1C70 | 290-0534-00 | B010100 | 8031832 | CAP, FXD, ELCTLT: 1UF, 20%, 35V | 05397 | T368A105M035AZ |
| A12A1C70 | 285-1338-00 | B031833 | | CAP, FXD, MTLZD: 1.0UF, 10%, 50V | 55112 | 185/1.0/K/50/AGA |
| A12A1C71 | 290-0534-00 | B010100 | 8031832 | CAP, FXD, ELCTLT: 1UF, 20%, 35V | 05397 | T368A105M035AZ |
| A12A1C71 | 285-1338-00 | 8031833 | | CAP, FXD, MTLZD: 1.0UF, 10%, 50V | 55112 | 185/1.0/K/50/AGA |
| A12A1C74 | 283-0594-00 | | | CAP, FXD, MICA DI: 0.001UF, 1%, 100V | 00853 | D151F102F0 |
| A12A1C77 | 283-0060-00 | B010100 | B031832 | CAP, FXD, CER DI: 100PF, 5%, 200V | 59660 | 855-535U2J101J |
| A12A1C77 | 283-0084-00 | B031833 | | CAP, FXD, CER DI: 270PF, 5%, 1000V | 59660 | 838533X5F02715 |
| A12A1C78 | 283-0060-00 | B010100 | B031832 | CAP, FXD, CER DI: 100PF, 5%, 200V | 59660 | 855-535U2J101J |
| A12A1C78 | 283-0084-00 | B031833 | | CAP, FXD, CER DI: 270PF, 5%, 1000V | 59660 | 838533X5F02715 |
| A12A1C80 | 283-0080-00 | B010100 | B031832 | CAP, FXD, CER DI: 0.022UF, +80-20%, 25V | 59821 | 2DDU60E223Z |
| A12A1C86 | 290-0580-00 | | | CAP, FXD, ELCTLT: 0.27UF, 20%, 50V | 05397 | T368A274M050AZ |
| A12A1C90 | 290-0778-00 | | | CAP, FXD, ELCTLT: 1UF, 20%, 50V, NPLZD | 54473 | ECE-A50N1 |
| A12A1C92 | 285-1123-00 | | | CAP, FXD, PLASTIC: 1UF, 20%, 200V | 14731 | 230B1C105M |
| A12A1C94 | 285-0695-00 | | | CAP, FXD, PLASTIC: 0.01UF, 10%, 200V | 56289 | 192P10392 |
| A12A1C121 | 285-0892-00 | | | CAP, FXD, PLASTIC: 0.22UF, 10%, 200V | 14752 | 650B1C224K |
| A12A1C124 | 290-0758-00 | | | CAP, FXD, ELCTLT: 2.2UF, +50-10%, 200V | 56289 | 502D227 |
| A12A1C125 | 290-0758-00 | | | CAP, FXD, ELCTLT: 2.2UF, +50-10%, 200V | 56289 | 502D227 |
| A12A1C132 | 290-0768-00 | | | CAP, FXD, ELCTLT: 10UF, +50-20%, 100WVDC | 54473 | ECE-A100V10L |
| A12A1C133 | 290-0768-00 | | | CAP, FXD, ELCTLT: 10UF, +50-20%, 100WVDC | 54473 | ECE-A100V10L |
| A12A1C134 | 290-0768-00 | | | CAP, FXD, ELCTLT: 10UF, +50-20%, 100WVDC | 54473 | ECE-A100V10L |
| A12A1C135 | 290-0768-00 | | | CAP, FXD, ELCTLT: 10UF, +50-20%, 100WVDC | 54473 | ECE-A100V10L |
| A12A1C142 | 290-0772-00 | | | CAP, FXD, ELCTLT: 330UF, +50-10%, 25VDC | 54473 | ECE-BIEV30S |

Replaceable Electrical Parts - 7904A

| Component No. | Tektronix Part No. | Serial/Assembly No. Effective | Dscont | Name & Description | Mfr. Code | Mfr. Part No. |
|---------------|--------------------|-------------------------------|---------|---|-----------|------------------|
| A12A1C143 | 290-0770-00 | | | CAP,FXD,ELCTLT:100UF,+50-20%,25VDC | 54473 | ECE-A25V100L |
| A12A1C144 | 290-0772-00 | | | CAP,FXD,ELCTLT:330UF,+50-10%,25VDC | 54473 | ECE-BIEV30S |
| A12A1C145 | 290-0770-00 | | | CAP,FXD,ELCTLT:100UF,+50-20%,25VDC | 54473 | ECE-A25V100L |
| A12A1C152 | 290-0771-00 | | | CAP,FXD,ELCTLT:220UF,+50-10%,10VDC | 55680 | ULA1A221TPA2 |
| A12A1C153 | 290-0771-00 | | | CAP,FXD,ELCTLT:220UF,+50-10%,10VDC | 55680 | ULA1A221TPA2 |
| A12A1C155 | 290-0773-00 | | | CAP,FXD,ELCTLT:1000UF,+50-10%,10VDC | 54473 | ECEB1AV102S |
| A12A1C156 | 290-0771-00 | | | CAP,FXD,ELCTLT:220UF,+50-10%,10VDC | 55680 | ULA1A221TPA2 |
| A12A1C172 | 290-0746-00 | | | CAP,FXD,ELCTLT:47UF,+50-20%,16V | 54473 | ECE-A6V47L |
| A12A1C179 | 283-0177-00 | B010100 | B031832 | CAP,FXD,CER DI:1UF,+80-20%,25V | 04222 | SR305E105ZAA |
| A12A1C179 | 285-1338-00 | B031833 | | CAP,FXD,MTLZD:1.0UF,10%,50V | 55112 | 185/1.0/K/50/AGA |
| A12A1C183 | 283-0111-00 | B010100 | B031832 | CAP,FXD,CER DI:0.1UF,20%,50V | 04222 | SR305C104MAA |
| A12A1C183 | 285-1300-01 | B031833 | | CAP,FXD,MTLZD:0.1UF,10%,63V | 55112 | 185/0.1/K/63/ABA |
| A12A1CR52 | 152-0333-00 | | | SEMICON DVC,DI:SW,SI,55V,200MA,DO-35 | 07263 | FDH-6012 |
| A12A1CR59 | 152-0333-00 | | | SEMICON DVC,DI:SW,SI,55V,200MA,DO-35 | 07263 | FDH-6012 |
| A12A1CR65 | 152-0141-02 | | | SEMICON DVC,DI:SW,SI,30V,150MA,30V,DO-35 | 03508 | DA2527 (1N4152) |
| A12A1CR66 | 152-0141-02 | | | SEMICON DVC,DI:SW,SI,30V,150MA,30V,DO-35 | 03508 | DA2527 (1N4152) |
| A12A1CR73 | 152-0333-00 | | | SEMICON DVC,DI:SW,SI,55V,200MA,DO-35 | 07263 | FDH-6012 |
| A12A1CR74 | 152-0333-00 | | | SEMICON DVC,DI:SW,SI,55V,200MA,DO-35 | 07263 | FDH-6012 |
| A12A1CR75 | 152-0333-00 | | | SEMICON DVC,DI:SW,SI,55V,200MA,DO-35 | 07263 | FDH-6012 |
| A12A1CR76 | 152-0333-00 | | | SEMICON DVC,DI:SW,SI,55V,200MA,DO-35 | 07263 | FDH-6012 |
| A12A1CR81 | 152-0333-00 | | | SEMICON DVC,DI:SW,SI,55V,200MA,DO-35 | 07263 | FDH-6012 |
| A12A1CR82 | 152-0333-00 | | | SEMICON DVC,DI:SW,SI,55V,200MA,DO-35 | 07263 | FDH-6012 |
| A12A1CR83 | 152-0333-00 | | | SEMICON DVC,DI:SW,SI,55V,200MA,DO-35 | 07263 | FDH-6012 |
| A12A1CR84 | 152-0333-00 | | | SEMICON DVC,DI:SW,SI,55V,200MA,DO-35 | 07263 | FDH-6012 |
| A12A1CR90 | 152-0141-02 | | | SEMICON DVC,DI:SW,SI,30V,150MA,30V,DO-35 | 03508 | DA2527 (1N4152) |
| A12A1CR120 | 152-0242-00 | | | SEMICON DVC,DI:SIG,SI,225V,0.2A,DO-7 | 07263 | FDH5004 |
| A12A1CR121 | 152-0242-00 | | | SEMICON DVC,DI:SIG,SI,225V,0.2A,DO-7 | 07263 | FDH5004 |
| A12A1CR122 | 152-0242-00 | | | SEMICON DVC,DI:SIG,SI,225V,0.2A,DO-7 | 07263 | FDH5004 |
| A12A1CR123 | 152-0242-00 | | | SEMICON DVC,DI:SIG,SI,225V,0.2A,DO-7 | 07263 | FDH5004 |
| A12A1CR124 | 152-0242-00 | | | SEMICON DVC,DI:SIG,SI,225V,0.2A,DO-7 | 07263 | FDH5004 |
| A12A1CR125 | 152-0242-00 | | | SEMICON DVC,DI:SIG,SI,225V,0.2A,DO-7 | 07263 | FDH5004 |
| A12A1CR127 | 152-0242-00 | | | SEMICON DVC,DI:SIG,SI,225V,0.2A,DO-7 | 07263 | FDH5004 |
| A12A1CR130 | 152-0586-00 | | | SEMICON DVC,DI:RECT,SI,600V,0.5A | 25403 | BYV96D OR BYV95C |
| A12A1CR131 | 152-0586-00 | | | SEMICON DVC,DI:RECT,SI,600V,0.5A | 25403 | BYV96D OR BYV95C |
| A12A1CR132 | 152-0586-00 | | | SEMICON DVC,DI:RECT,SI,600V,0.5A | 25403 | BYV96D OR BYV95C |
| A12A1CR133 | 152-0586-00 | | | SEMICON DVC,DI:RECT,SI,600V,0.5A | 25403 | BYV96D OR BYV95C |
| A12A1CR140 | 152-0397-00 | | | SEMICON DVC,DI:RECT,SI,100V,12A | 80009 | 152-0397-00 |
| A12A1CR141 | 152-0397-00 | | | SEMICON DVC,DI:RECT,SI,100V,12A | 80009 | 152-0397-00 |
| A12A1CR142 | 152-0397-00 | | | SEMICON DVC,DI:RECT,SI,100V,12A | 80009 | 152-0397-00 |
| A12A1CR143 | 152-0397-00 | | | SEMICON DVC,DI:RECT,SI,100V,12A | 80009 | 152-0397-00 |
| A12A1CR151 | 152-0692-00 | | | SEMICON DVC,DI:SI,20V,30A,T0-3 | 04713 | SD241 |
| A12A1CR161 | 152-0008-00 | B010100 | B021704 | SEMICON DVC,DI:SIG,GE,60V,60MA,A38A | 14433 | G1409 |
| A12A1CR161 | 152-0725-00 | B021705 | | SEMICON DVC,DI:SI,SCHOTTKY,20V,1.2PF,DO-35 | 21847 | A2X1582 |
| A12A1CR171 | 152-0141-02 | | | SEMICON DVC,DI:SW,SI,30V,150MA,30V,DO-35 | 03508 | DA2527 (1N4152) |
| A12A1CR183 | 152-0141-02 | | | SEMICON DVC,DI:SW,SI,30V,150MA,30V,DO-35 | 03508 | DA2527 (1N4152) |
| A12A1L132 | 108-0473-00 | | | COIL,RF:FIXED,174UH | TK2042 | ORDER BY DESC |
| A12A1L134 | 108-0473-00 | | | COIL,RF:FIXED,174UH | TK2042 | ORDER BY DESC |
| A12A1L142 | 108-0680-00 | | | COIL,RF:FIXED,27UH | TK1345 | 108-0680-00 |
| A12A1L144 | 108-0680-00 | | | COIL,RF:FIXED,27UH | TK1345 | 108-0680-00 |
| A12A1L152 | 108-0473-00 | | | COIL,RF:FIXED,174UH | TK2042 | ORDER BY DESC |
| A12A1L154 | 108-0556-00 | | | COIL,RF:FIXED,12UH | TK1345 | 108-0556-00 |
| A12A1P5 | 131-0608-00 | | | TERMINAL,PIN:0.365 L X 0.025 BRZ GLD PL (QUANTITY OF 4) | 22526 | 48283-036 |
| A12A1P40 | 131-0589-00 | B010100 | B031832 | TERMINAL,PIN:0.46 L X 0.025 SQ PH BRZ (QUANTITY OF 4) | 22526 | 48283-029 |
| A12A1P48 | 131-0608-00 | B010100 | B031832 | TERMINAL,PIN:0.365 L X 0.025 BRZ GLD PL (QUANTITY OF 5) | 22526 | 48283-036 |
| A12A1P50 | 131-0608-00 | B010100 | B031832 | TERMINAL,PIN:0.365 L X 0.025 BRZ GLD PL (QUANTITY OF 7) | 22526 | 48283-036 |

| Component No. | Tektronix Part No. | Serial/Assembly No. Effective | Discont | Name & Description | Mfr. Code | Mfr. Part No. |
|---------------|--------------------|-------------------------------|---------|--|-----------|-----------------|
| A12A1P52 | 131-0608-00 | B010100 | B031832 | TERMINAL, PIN:0.365 L X 0.025 BRZ GLD PL (QUANTITY OF 6) | 22526 | 48283-036 |
| A12A1P54 | 131-0608-00 | B010100 | B031832 | TERMINAL, PIN:0.365 L X 0.025 BRZ GLD PL (QUANTITY OF 4) | 22526 | 48283-036 |
| A12A1Q52 | 151-0302-00 | | | TRANSISTOR:NPN,SI, TO-18 | 04713 | ST899 |
| A12A1Q54 | 151-0273-00 | | | TRANSISTOR:SELECTED | 03508 | X16E3616 |
| A12A1Q162 | 151-0190-05 | B010100 | B031832 | TRANSISTOR:SELECTED 2N3904 | 80009 | 151-0190-05 |
| A12A1Q162 | 151-0190-00 | B031833 | | TRANSISTOR:NPN,SI, TO-92 | 80009 | 151-0190-00 |
| A12A1Q171 | 151-0190-05 | B010100 | B031832 | TRANSISTOR:SELECTED 2N3904 | 80009 | 151-0190-05 |
| A12A1Q171 | 151-0190-00 | B031833 | | TRANSISTOR:NPN,SI, TO-92 | 80009 | 151-0190-00 |
| A12A1Q173 | 151-0188-03 | B010100 | B031832 | TRANSISTOR:SELECTED | 80009 | 151-0188-03 |
| A12A1Q173 | 151-0188-00 | B031833 | | TRANSISTOR:PMP,SI, TO-92 | 80009 | 151-0188-00 |
| A12A1Q177 | 151-0188-03 | B010100 | B031832 | TRANSISTOR:SELECTED | 80009 | 151-0188-03 |
| A12A1Q177 | 151-0188-00 | B031833 | | TRANSISTOR:PMP,SI, TO-92 | 80009 | 151-0188-00 |
| A12A1R52 | 315-0512-00 | | | RES,FXD, FILM:5.1K OHM,5%,0.25W | 57668 | NTR25J-E05K1 |
| A12A1R54 | 315-0753-00 | | | RES,FXD, FILM:75K OHM,5%,0.25W | 57668 | NTR25J-E75K0 |
| A12A1R55 | 315-0201-00 | | | RES,FXD, FILM:200 OHM,5%,0.25W | 57668 | NTR25J-E200E |
| A12A1R59 | 315-0562-00 | | | RES,FXD, FILM:5.6K OHM,5%,0.25W | 57668 | NTR25J-E05K6 |
| A12A1R60 | 315-0224-00 | | | RES,FXD, FILM:220K OHM,5%,0.25W | 57668 | NTR25J-E220K |
| A12A1R61 | 315-0123-00 | | | RES,FXD, FILM:12K OHM,5%,0.25W | 57668 | NTR25J-E12K0 |
| A12A1R62 | 315-0301-00 | | | RES,FXD, FILM:300 OHM,5%,0.25W | 57668 | NTR25J-E300E |
| A12A1R63 | 315-0184-00 | | | RES,FXD, FILM:47 OHM,5%,0.25W | 57668 | NTR25J-E47E0 |
| A12A1R64 | 315-0102-00 | | | RES,FXD, FILM:1K OHM,5%,0.25W | 57668 | NTR25JE01K0 |
| A12A1R66 | 315-0202-00 | | | RES,FXD, FILM:2K OHM,5%,0.25W | 57668 | NTR25J-E 2K |
| A12A1R67 | 315-0154-00 | | | RES,FXD, FILM:150K OHM,5%,0.25W | 57668 | NTR25J-E150K |
| A12A1R70 | 315-0560-00 | | | RES,FXD, FILM:56 OHM,5%,0.25W | 57668 | NTR25J-E56E0 |
| A12A1R71 | 315-0560-00 | | | RES,FXD, FILM:56 OHM,5%,0.25W | 57668 | NTR25J-E56E0 |
| A12A1R74 | 321-0346-00 | | | RES,FXD, FILM:39.2K OHM,1%,0.125W,TC=TO | 19701 | 5043ED39K20F |
| A12A1R80 | 315-0471-00 | | | RES,FXD, FILM:470 OHM,5%,0.25W | 57668 | NTR25J-E470E |
| A12A1R81 | 321-0334-00 | | | RES,FXD, FILM:29.4K OHM,1%,0.125W,TC=TO | 07716 | CEAD29401F |
| A12A1R82 | 321-0340-00 | | | RES,FXD, FILM:34.0K OHM,1%,0.125W,TC=TO | 19701 | 5043ED34K00F |
| A12A1R83 | 321-0193-00 | | | RES,FXD, FILM:1K OHM,1%,0.125W,TC=TO | 19701 | 5033ED1K00F |
| A12A1R84 | 321-0005-00 | | | RES,FXD, FILM:11.0 OHM,1%,0.125W,TC=TO | 91637 | CMF55116G1R00F |
| A12A1R86 | 321-0284-00 | | | RES,FXD, FILM:8.87K OHM,1%,0.125W,TC=TO | 19701 | 5043ED8K870F |
| A12A1R87 | 321-0283-00 | | | RES,FXD, FILM:8.66K OHM,1%,0.125W,TC=TO | 19701 | 5043ED8K660F |
| A12A1R88 | 315-0122-00 | | | RES,FXD, FILM:1.2K OHM,5%,0.25W | 57668 | NTR25J-E01K2 |
| A12A1R90 | 315-0272-00 | | | RES,FXD, FILM:2.7K OHM,5%,0.25W | 57668 | NTR25J-E02K7 |
| A12A1R92 | 315-0105-00 | | | RES,FXD, FILM:1M OHM,5%,0.25W | 19701 | 5043CX1M000J |
| A12A1R93 | 311-1239-00 | B010100 | B031832 | RES,VAR,NONWV:TRMR,2.5K OHM,0.5W | 32997 | 3386X-T07-252 |
| A12A1R93 | 311-2273-00 | B031833 | | RES,VAR,NONWV:TRMR,2K OHM,20%,0.5W | TK1450 | GF06VT 2 K OHM |
| A12A1R94 | 315-0203-00 | | | RES,FXD, FILM:20K OHM,5%,0.25W | 57668 | NTR25J-E 20K |
| A12A1R95 | 321-0419-00 | B010100 | B042342 | RES,FXD, FILM:226K OHM,1%,0.125W,TC=TO | 07716 | CEAD22602F |
| A12A1R95 | 321-0418-00 | B042343 | | RES,FXD, FILM:221K OHM,1%,0.125W,TC=TO | 07716 | CEAD22102F |
| A12A1R120 | 315-0150-00 | | | RES,FXD, FILM:15 OHM,5%,0.25W | 19701 | 5043CX15R00J |
| A12A1R121 | 315-0101-00 | | | RES,FXD, FILM:100 OHM,5%,0.25W | 57668 | NTR25J-E 100E |
| A12A1R127 | 301-0391-00 | | | RES,FXD, FILM:390 OHM,5%,0.5W | 01121 | EB3915 |
| A12A1R161 | 315-0473-00 | | | RES,FXD, FILM:47K OHM,5%,0.25W | 57668 | NTR25J-E47K0 |
| A12A1R162 | 315-0472-00 | | | RES,FXD, FILM:4.7K OHM,5%,0.25W | 57668 | NTR25J-E04K7 |
| A12A1R170 | 315-0100-00 | | | RES,FXD, FILM:10 OHM,5%,0.25W | 19701 | 5043CX10RR00J |
| A12A1R171 | 315-0274-00 | | | RES,FXD, FILM:270K OHM,5%,0.25W | 57668 | NTR25J-E270K |
| A12A1R172 | 315-0474-00 | | | RES,FXD, FILM:470K OHM,5%,0.25W | 19701 | 5043CX470K0J92U |
| A12A1R173 | 315-0272-00 | | | RES,FXD, FILM:2.7K OHM,5%,0.25W | 57668 | NTR25J-E02K7 |
| A12A1R174 | 315-0182-00 | | | RES,FXD, FILM:1.8K OHM,5%,0.25W | 57668 | NTR25J-E1K8 |
| A12A1R176 | 315-0203-00 | | | RES,FXD, FILM:20K OHM,5%,0.25W | 57668 | NTR25J-E 20K |
| A12A1R177 | 315-0203-00 | | | RES,FXD, FILM:20K OHM,5%,0.25W | 57668 | NTR25J-E 20K |
| A12A1R179 | 315-0472-00 | | | RES,FXD, FILM:4.7K OHM,5%,0.25W | 57668 | NTR25J-E04K7 |
| A12A1R181 | 315-0334-00 | | | RES,FXD, FILM:330K OHM,5%,0.25W | 57668 | NTR25J-E 330K |
| A12A1R182 | 315-0754-00 | | | RES,FXD, FILM:750K OHM,5%,0.25W,MI | 19701 | 5043CX750K0J |

Replaceable Electrical Parts - 7904A

| Component No. | Tektronix Part No. | Serial/Assembly No. Effective | Discont | Name & Description | Mfr. Code | Mfr. Part No. |
|---------------|--------------------|-------------------------------|---------|--|-----------|------------------|
| A12A1TPO | 214-0579-00 | B010100 | B031B32 | TERM,TEST POINT:BRS CD PL | 80009 | 214-0579-00 |
| A12A1TP126 | 214-0579-00 | B010100 | B031B32 | TERM,TEST POINT:BRS CD PL | 80009 | 214-0579-00 |
| A12A1U75 | 155-0067-02 | | | MICROCKT,DGTL:POWER SPLY RGLTR | 80009 | 155-0067-02 |
| A12A1U179 | 156-0481-02 | | | MICROCKT,DGTL:TRIPLE 3-INP & GATE,SCRN | 80009 | 156-0481-02 |
| A12A1VR52 | 152-0590-00 | | | SEMICON DVC,DI:ZEN,SI,1BV,5%,400MW | 80009 | 152-0590-00 |
| A12A1VR72 | 152-0243-00 | | | SEMICON DVC,DI:ZEN,SI,15V,5%,0.4W,DO-7 | 14433 | Z5412 |
| A12A1VR88 | 152-0212-00 | B010100 | B042342 | SEMICON DVC,DI:ZEN,SI,9V,5%,0.5W,DO-7 | 04713 | SZ50646RL |
| A12A1VR88 | 152-1006-00 | B042343 | | SEMICON DVC,DI:ZENER,SI,9V,2%,500MV,DO-7 | 80009 | 152-1006-00 |
| A13 | 670-4777-20 | | | CIRCUIT BD ASSY:LOGIC | B0009 | 670-4777-20 |
| A13C4301 | 283-0177-00 | | | CAP,FXD,CER DI:1UF,+80-20%,25V | 04222 | SR305E10SZA |
| A13C4302 | 283-0177-00 | | | CAP,FXD,CER DI:1UF,+80-20%,25V | 04222 | SR305E10SZA |
| A13C4303 | 283-0177-00 | | | CAP,FXD,CER DI:1UF,+80-20%,25V | 04222 | SR305E10SZA |
| A13C4304 | 283-0177-00 | | | CAP,FXD,CER DI:1UF,+80-20%,25V | 04222 | SR305E10SZA |
| A13C4305 | 290-0755-00 | | | CAP,FXD,ELCTL:100UF,+50%-20%,10WVDC | 54473 | ECE-A10V100L |
| A13C4314 | 283-0672-00 | | | CAP,FXD,MICA DI:200PF,1%,500V | 00853 | D155F2010F0 |
| A13C4315 | 281-0603-00 | | | CAP,FXD,CER DI:39PF,5%,500V | 52763 | 2RDPLZ007 39PQJC |
| A13C4316 | 283-0177-00 | | | CAP,FXD,CER DI:1UF,+80-20%,25V | 04222 | SR305E10SZA |
| A13C4335 | 281-0603-00 | | | CAP,FXD,CER DI:39PF,5%,500V | 52763 | 2RDPLZ007 39PQJC |
| A13C4336 | 281-0549-00 | | | CAP,FXD,CER DI:68PF,10%,500V | 52763 | 2RDPLZ007 68PQKJ |
| A13C4342 | 283-0032-00 | | | CAP,FXD,CER DI:470PF,5%,500V | 59660 | 831-000-Z5E0471J |
| A13C4343 | 281-0782-00 | | | CAP,FXD,CER DI:33 PF,10%,500V | 52763 | 2RDPLZ007 33PQKE |
| A13C4345 | 281-0782-00 | | | CAP,FXD,CER DI:33 PF,10%,500V | 52763 | 2RDPLZ007 33PQKE |
| A13C4346 | 283-0032-00 | | | CAP,FXD,CER DI:470PF,5%,500V | 59660 | 831-000-Z5E0471J |
| A13C4347 | 283-0638-00 | | | CAP,FXD,MICA DI:130PF,1%,500V | 00853 | D155F131F0 |
| A13C4423 | 281-0603-00 | | | CAP,FXD,CER DI:39PF,5%,500V | 52763 | 2RDPLZ007 39PQJC |
| A13C4441 | 281-0603-00 | | | CAP,FXD,CER DI:39PF,5%,500V | 52763 | 2RDPLZ007 39PQJC |
| A13C4449 | 283-0003-00 | | | CAP,FXD,CER DI:0.01UF,+80-20%,150V | 59821 | D103Z40Z5UJDCX |
| A13C4461 | 281-0589-00 | | | CAP,FXD,CER DI:170PF,5%,500V | 52763 | 2RDPLZ007170PJK |
| A13C4467 | 281-0589-00 | | | CAP,FXD,CER DI:170PF,5%,500V | 52763 | 2RDPLZ007170PJK |
| A13C4470 | 283-0111-00 | | | CAP,FXD,CER DI:0.1UF,20%,50V | 04222 | SR305C104MAA |
| A13C4475 | 283-0177-00 | | | CAP,FXD,CER DI:1UF,+80-20%,25V | 04222 | SR305E10SZA |
| A13C4483 | 283-0000-00 | | | CAP,FXD,CER DI:0.001UF,+100-0%,500V | 59660 | 831-610-Y5U0102P |
| A13C4484 | 283-0177-00 | | | CAP,FXD,CER DI:1UF,+80-20%,25V | 04222 | SR305E10SZA |
| A13C4485 | 283-0060-00 | | | CAP,FXD,CER DI:100PF,5%,200V | 59660 | B55-535U2J101J |
| A13CR4322 | 152-0242-00 | | | SEMICON DVC,DI:SIG,SI,225V,0.2A,DO-7 | 07263 | FDH5004 |
| A13CR4323 | 152-0322-00 | | | SEMICON DVC,DI:SCHOTTKY,SI,15V,1.2PF,DO-35 | 50434 | 5082-2672 |
| A13CR4354 | 152-0141-02 | | | SEMICON DVC,DI:SW,SI,30V,150MA,30V,DO-35 | 03508 | DA2527 (1N4152) |
| A13CR4355 | 152-0141-02 | | | SEMICON DVC,DI:SW,SI,30V,150MA,30V,DO-35 | 03508 | DA2527 (1N4152) |
| A13CR4356 | 152-0141-02 | | | SEMICON DVC,DI:SW,SI,30V,150MA,30V,DO-35 | 03508 | DA2527 (1N4152) |
| A13CR4357 | 152-0141-02 | | | SEMICON DVC,DI:SW,SI,30V,150MA,30V,DO-35 | 03508 | DA2527 (1N4152) |
| A13CR4368 | 152-0141-02 | | | SEMICON DVC,DI:SW,SI,30V,150MA,30V,DO-35 | 03508 | DA2527 (1N4152) |
| A13CR4369 | 152-0141-02 | | | SEMICON DVC,DI:SW,SI,30V,150MA,30V,DO-35 | 03508 | DA2527 (1N4152) |
| A13CR4433 | 152-0141-02 | | | SEMICON DVC,DI:SW,SI,30V,150MA,30V,DO-35 | 03508 | DA2527 (1N4152) |
| A13CR4434 | 152-0141-02 | | | SEMICON DVC,DI:SW,SI,30V,150MA,30V,DO-35 | 03508 | DA2527 (1N4152) |
| A13CR4448 | 152-0141-02 | | | SEMICON DVC,DI:SW,SI,30V,150MA,30V,DO-35 | 03508 | DA2527 (1N4152) |
| A13CR4449 | 152-0141-02 | | | SEMICON DVC,DI:SW,SI,30V,150MA,30V,DO-35 | 03508 | DA2527 (1N4152) |
| A13CR4461 | 152-0141-02 | | | SEMICON DVC,DI:SW,SI,30V,150MA,30V,DO-35 | 03508 | DA2527 (1N4152) |
| A13CR4467 | 152-0141-02 | | | SEMICON DVC,DI:SW,SI,30V,150MA,30V,DO-35 | 03508 | DA2527 (1N4152) |
| A13CR4471 | 152-0153-00 | | | SEMICON DVC,DI:SW,SI,10V,50MA,DO-7 | 07263 | FD7003 |
| A13CR4472 | 152-0141-02 | | | SEMICON DVC,DI:SW,SI,30V,150MA,30V,DO-35 | 03508 | DA2527 (1N4152) |
| A13CR4473 | 152-0141-02 | | | SEMICON DVC,DI:SW,SI,30V,150MA,30V,DO-35 | 03508 | DA2527 (1N4152) |
| A13CR4474 | 152-0141-02 | | | SEMICON DVC,DI:SW,SI,30V,150MA,30V,DO-35 | 03508 | DA2527 (1N4152) |
| A13CR4487 | 152-0075-00 | B010100 | B021704 | SEMICON DVC,DI:SW,GE,22V,80MW,DO-7 | B0009 | 152-0075-00 |
| A13CR4487 | 152-0664-00 | B021705 | | SEMICON DVC,DI:SCHOTTKY,SW,SI,70V,DO-35 | 80009 | 152-0664-00 |
| A13CR4491 | 152-0075-00 | | | SEMICON DVC,DI:SW,GE,22V,80MW,DO-7 | 80009 | 152-0075-00 |
| A13CR4492 | 152-0141-02 | | | SEMICON DVC,DI:SW,SI,30V,150MA,30V,DO-35 | 03508 | DA2527 (1N4152) |
| A13CR4493 | 152-0141-02 | | | SEMICON DVC,DI:SW,SI,30V,150MA,30V,DO-35 | 03508 | DA2527 (1N4152) |
| A13CR4494 | 152-0581-00 | | | SEMICON DVC,DI:RECT,SI,20V,1A,A59 | 04713 | 1N5817 |

| Component No. | Tektronix Part No. | Serial/Assembly No. Effective Dscont | Name & Description | Mfr. Code | Mfr. Part No. |
|---------------|--------------------|--------------------------------------|--|-----------|-----------------|
| A13CR4495 | 152-0141-02 | | SEMICON DVC,DI:SW,SI,30V,150MA,30V,DO-35 | 03508 | DA2527 (1N4152) |
| A13CR4496 | 152-0141-02 | | SEMICON DVC,DI:SW,SI,30V,150MA,30V,DO-35 | 03508 | DA2527 (1N4152) |
| A13CR4498 | 152-0141-02 | | SEMICON DVC,DI:SW,SI,30V,150MA,30V,DO-35 | 03508 | DA2527 (1N4152) |
| A13CR4499 | 152-0581-00 | | SEMICON DVC,DI:RECT,SI,20V,1A,A59 | 04713 | 1N5817 |
| A13J4406 | 131-1003-00 | | CONN,RCPT,ELEC:CKT BD MT,3 PRONG | 80009 | 131-1003-00 |
| A13L4301 | 108-0245-00 | | CHOKE,RF:FIXED,3.9UH | 76493 | 86310-1 |
| A13L4302 | 108-0245-00 | | CHOKE,RF:FIXED,3.9UH | 76493 | 86310-1 |
| A13L4303 | 108-0245-00 | | CHOKE,RF:FIXED,3.9UH | 76493 | 86310-1 |
| A13L4304 | 108-0245-00 | | CHOKE,RF:FIXED,3.9UH | 76493 | 86310-1 |
| A13L4317 | 108-0245-00 | | CHOKE,RF:FIXED,3.9UH | 76493 | 86310-1 |
| A13L4342 | 108-0245-00 | | CHOKE,RF:FIXED,3.9UH | 76493 | 86310-1 |
| A13L4344 | 108-0245-00 | | CHOKE,RF:FIXED,3.9UH | 76493 | 86310-1 |
| A13LR4338 | 108-0543-00 | | COIL,RF:FIXED,1.1UH | TK1345 | 108-0543-00 |
| A13LR4359 | 108-0543-00 | | COIL,RF:FIXED,1.1UH | TK1345 | 108-0543-00 |
| A13LR4368 | 108-0543-00 | | COIL,RF:FIXED,1.1UH | TK1345 | 108-0543-00 |
| A13LR4412 | 108-0543-00 | | COIL,RF:FIXED,1.1UH | TK1345 | 108-0543-00 |
| A13Q4336 | 151-0198-00 | | TRANSISTOR:SELECTED | 80009 | 151-0198-00 |
| A13Q4364 | 151-0198-00 | | TRANSISTOR:SELECTED | 80009 | 151-0198-00 |
| A13Q4374 | 151-0188-00 | | TRANSISTOR:PNP,SI,T0-92 | 80009 | 151-0188-00 |
| A13Q4382 | 151-0192-00 | | TRANSISTOR:NPN,SI,T0-92 | 04713 | SPS8801 |
| A13Q4392 | 151-0192-00 | | TRANSISTOR:NPN,SI,T0-92 | 04713 | SPS8801 |
| A13Q4424 | 151-0192-00 | | TRANSISTOR:NPN,SI,T0-92 | 04713 | SPS8801 |
| A13Q4432 | 151-0223-00 | | TRANSISTOR:NPN,SI,625MW,T0-92 | 80009 | 151-0223-00 |
| A13Q4438 | 151-0192-00 | | TRANSISTOR:NPN,SI,T0-92 | 04713 | SPS8801 |
| A13Q4442 | 151-0192-00 | | TRANSISTOR:NPN,SI,T0-92 | 04713 | SPS8801 |
| A13Q4448 | 151-0216-00 | | TRANSISTOR:PNP,SI,T0-92 | 04713 | SPS8803 |
| A13Q4456 | 151-1022-00 | | TRANSISTOR:FET,N-CHAN,SI,T0-18 | 80009 | 151-1022-00 |
| A13Q4462 | 151-0192-00 | | TRANSISTOR:NPN,SI,T0-92 | 04713 | SPS8801 |
| A13Q4468 | 151-0192-00 | | TRANSISTOR:NPN,SI,T0-92 | 04713 | SPS8801 |
| A13Q4480 | 151-0188-00 | | TRANSISTOR:PNP,SI,T0-92 | 80009 | 151-0188-00 |
| A13Q4488 | 151-0192-00 | | TRANSISTOR:NPN,SI,T0-92 | 04713 | SPS8801 |
| A13Q4492 | 151-0188-00 | | TRANSISTOR:PNP,SI,T0-92 | 80009 | 151-0188-00 |
| A13Q4494 | 151-0302-00 | | TRANSISTOR:NPN,SI,T0-18 | 04713 | ST899 |
| A13Q4498 | 151-0302-00 | | TRANSISTOR:NPN,SI,T0-18 | 04713 | ST899 |
| A13R4302 | 315-0100-00 | | RES,FXD,FILM:10 OHM,5%,0.25W | 19701 | 5043CX10R00J |
| A13R4304 | 315-0223-00 | | RES,FXD,FILM:22K OHM,5%,0.25W | 19701 | 5043CX22K00J92U |
| A13R4305 | 321-0193-00 | | RES,FXD,FILM:1K OHM,1%,0.125W,TC=TO | 19701 | 5033ED1K00F |
| A13R4306 | 315-0223-00 | | RES,FXD,FILM:22K OHM,5%,0.25W | 19701 | 5043CX22K00J92U |
| A13R4307 | 321-0193-00 | | RES,FXD,FILM:1K OHM,1%,0.125W,TC=TO | 19701 | 5033ED1K00F |
| A13R4312 | 321-0147-00 | | RES,FXD,FILM:332 OHM,1%,0.125W,TC=TO | 07716 | CEAD332R0F |
| A13R4313 | 321-0239-00 | | RES,FXD,FILM:3.01K OHM,1%,0.125W,TC=TO | 19701 | 5043ED3K010F |
| A13R4314 | 315-0912-00 | | RES,FXD,FILM:9.1K OHM,5%,0.25W | 57668 | NTR25J-E09K1 |
| A13R4315 | 315-0512-00 | | RES,FXD,FILM:5.1K OHM,5%,0.25W | 57668 | NTR25J-E05K1 |
| A13R4316 | 315-0201-00 | | RES,FXD,FILM:200 OHM,5%,0.25W | 57668 | NTR25J-E200E |
| A13R4318 | 315-0101-00 | | RES,FXD,FILM:100 OHM,5%,0.25W | 57668 | NTR25J-E 10DE |
| A13R4319 | 315-0512-00 | | RES,FXD,FILM:5.1K OHM,5%,0.25W | 57668 | NTR25J-E05K1 |
| A13R4321 | 315-0332-00 | | RES,FXD,FILM:3.3K OHM,5%,0.25W | 57668 | NTR25J-E03K3 |
| A13R4322 | 315-0202-00 | | RES,FXD,FILM:2K OHM,5%,0.25W | 57668 | NTR25J-E 2K |
| A13R4333 | 315-0682-00 | | RES,FXD,FILM:6.8K OHM,5%,0.25W | 57668 | NTR25J-E06K8 |
| A13R4334 | 315-0303-00 | | RES,FXD,FILM:30K OHM,5%,0.25W | 19701 | 5043CX30K00J |
| A13R4335 | 315-0512-00 | | RES,FXD,FILM:5.1K OHM,5%,0.25W | 57668 | NTR25J-E05K1 |
| A13R4336 | 315-0752-00 | | RES,FXD,FILM:7.5K OHM,5%,0.25W | 57668 | NTR25J-E07K5 |
| A13R4342 | 315-0271-00 | | RES,FXD,FILM:270 OHM,5%,0.25W | 57668 | NTR25J-E270E |
| A13R4343 | 315-0222-00 | | RES,FXD,FILM:2.2K OHM,5%,0.25W | 57668 | NTR25J-E02K2 |
| A13R4344 | 315-0271-00 | | RES,FXD,FILM:270 OHM,5%,0.25W | 57668 | NTR25J-E270E |
| A13R4345 | 315-0332-00 | | RES,FXD,FILM:3.3K OHM,5%,0.25W | 57668 | NTR25J-E03K3 |
| A13R4354 | 315-0332-00 | | RES,FXD,FILM:3.3K OHM,5%,0.25W | 57668 | NTR25J-E03K3 |
| A13R4356 | 315-0152-00 | | RES,FXD,FILM:1.5K OHM,5%,0.25W | 57668 | NTR25J-E01K5 |

Replaceable Electrical Parts - 7904A

| Component No. | Tektronix Part No. | Serial/Assembly No. Effective Dscont | Name & Description | Mfr. Code | Mfr. Part No. |
|---------------|--------------------|--------------------------------------|--|-----------|---------------|
| A13R4357 | 315-0102-00 | | RES,FXD,FILM:1K OHM,5%,0.25W | 57668 | NTR25JE01K0 |
| A13R4358 | 315-0101-00 | | RES,FXD,FILM:100 OHM,5%,0.25W | 57668 | NTR25J-E 100E |
| A13R4363 | 315-0102-00 | | RES,FXD,FILM:1K OHM,5%,0.25W | 57668 | NTR25JE01K0 |
| A13R4366 | 315-0332-00 | | RES,FXD,FILM:3.3K OHM,5%,0.25W | 57668 | NTR25J-E03K3 |
| A13R4367 | 315-0101-00 | | RES,FXD,FILM:100 OHM,5%,0.25W | 57668 | NTR25J-E 100E |
| A13R4369 | 315-0202-00 | | RES,FXD,FILM:2K OHM,5%,0.25W | 57668 | NTR25J-E 2K |
| A13R4374 | 315-0103-00 | | RES,FXD,FILM:10K OHM,5%,0.25W | 19701 | 5043CX10K00J |
| A13R4380 | 315-0302-00 | | RES,FXD,FILM:3K OHM,5%,0.25W | 57668 | NTR25J-E03K0 |
| A13R4381 | 315-0303-00 | | RES,FXD,FILM:30K OHM,5%,0.25W | 19701 | 5043CX30K00J |
| A13R4382 | 315-0122-00 | | RES,FXD,FILM:1.2K OHM,5%,0.25W | 57668 | NTR25J-E01K2 |
| A13R4390 | 315-0301-00 | | RES,FXD,FILM:300 OHM,5%,0.25W | 57668 | NTR25J-E300E |
| A13R4391 | 315-0102-00 | | RES,FXD,FILM:1K OHM,5%,0.25W | 57668 | NTR25JE01K0 |
| A13R4392 | 315-0202-00 | | RES,FXD,FILM:2K OHM,5%,0.25W | 57668 | NTR25J-E 2K |
| A13R4394 | 315-0100-00 | | RES,FXD,FILM:10 OHM,5%,0.25W | 19701 | 5043CX10RR00J |
| A13R4413 | 315-0332-00 | | RES,FXD,FILM:3.3K OHM,5%,0.25W | 57668 | NTR25J-E03K3 |
| A13R4422 | 315-0153-00 | | RES,FXD,FILM:15K OHM,5%,0.25W | 19701 | 5043CX15K00J |
| A13R4423 | 315-0201-00 | | RES,FXD,FILM:200 OHM,5%,0.25W | 57668 | NTR25J-E200E |
| A13R4424 | 315-0512-00 | | RES,FXD,FILM:5.1K OHM,5%,0.25W | 57668 | NTR25J-E05K1 |
| A13R4425 | 315-0201-00 | | RES,FXD,FILM:200 OHM,5%,0.25W | 57668 | NTR25J-E200E |
| A13R4431 | 315-0152-00 | | RES,FXD,FILM:1.5K OHM,5%,0.25W | 57668 | NTR25J-E01K5 |
| A13R4432 | 315-0222-00 | | RES,FXD,FILM:2.2K OHM,5%,0.25W | 57668 | NTR25J-E02K2 |
| A13R4437 | 315-0103-00 | | RES,FXD,FILM:10K OHM,5%,0.25W | 19701 | 5043CX10K00J |
| A13R4438 | 315-0821-00 | | RES,FXD,FILM:820 OHM,5%,0.25W | 19701 | 5043CX820R0J |
| A13R4441 | 315-0822-00 | | RES,FXD,FILM:8.2K OHM,5%,0.25W | 19701 | 5043CX8K200J |
| A13R4442 | 315-0132-00 | | RES,FXD,FILM:1.3K OHM,5%,0.25W | 57668 | NTR25J-E01K3 |
| A13R4448 | 315-0271-00 | | RES,FXD,FILM:270 OHM,5%,0.25W | 57668 | NTR25J-E270E |
| A13R4449 | 315-0302-00 | | RES,FXD,FILM:3K OHM,5%,0.25W | 57668 | NTR25J-E03K0 |
| A13R4456 | 315-0821-00 | | RES,FXD,FILM:820 OHM,5%,0.25W | 19701 | 5043CX820R0J |
| A13R4461 | 321-0290-00 | | RES,FXD,FILM:10.2K OHM,1%,0.125W,TC=TO | 19701 | 5043ED10K20F |
| A13R4462 | 321-0246-00 | | RES,FXD,FILM:3.57K OHM,1%,0.125W,TC=TO | 19701 | 5043ED3K570F |
| A13R4467 | 321-0290-00 | | RES,FXD,FILM:10.2K OHM,1%,0.125W,TC=TO | 19701 | 5043ED10K20F |
| A13R4468 | 321-0246-00 | | RES,FXD,FILM:3.57K OHM,1%,0.125W,TC=TO | 19701 | 5043ED3K570F |
| A13R4470 | 315-0100-00 | | RES,FXD,FILM:10 OHM,5%,0.25W | 19701 | 5043CX10RR00J |
| A13R4471 | 321-0243-00 | | RES,FXD,FILM:3.32K OHM,1%,0.125W,TC=TO | 19701 | 5033ED3K32F |
| A13R4472 | 315-0242-00 | | RES,FXD,FILM:2.4K OHM,5%,0.25W | 57668 | NTR25J-E02K4 |
| A13R4473 | 315-0512-00 | | RES,FXD,FILM:5.1K OHM,5%,0.25W | 57668 | NTR25J-E05K1 |
| A13R4474 | 315-0512-00 | | RES,FXD,FILM:5.1K OHM,5%,0.25W | 57668 | NTR25J-E05K1 |
| A13R4475 | 315-0151-00 | | RES,FXD,FILM:150 OHM,5%,0.25W | 57668 | NTR25J-E150E |
| A13R4476 | 321-0243-00 | | RES,FXD,FILM:3.32K OHM,1%,0.125W,TC=TO | 19701 | 5033ED3K32F |
| A13R4477 | 315-0103-00 | | RES,FXD,FILM:10K OHM,5%,0.25W | 19701 | 5043CX10K00J |
| A13R4478 | 321-0205-00 | | RES,FXD,FILM:1.33K OHM,1%,0.125W,TC=TO | 19701 | 5033ED1K330F |
| A13R4480 | 315-0511-00 | | RES,FXD,FILM:510 OHM,5%,0.25W | 19701 | 5043CX510R0J |
| A13R4481 | 315-0332-00 | | RES,FXD,FILM:3.3K OHM,5%,0.25W | 57668 | NTR25J-E03K3 |
| A13R4482 | 321-0222-00 | | RES,FXD,FILM:2.00K OHM,1%,0.125W,TC=TO | 19701 | 5033ED2K00F |
| A13R4483 | 321-0222-00 | | RES,FXD,FILM:2.00K OHM,1%,0.125W,TC=TO | 19701 | 5033ED2K00F |
| A13R4484 | 315-0913-00 | | RES,FXD,FILM:91K OHM,5%,0.25W | 19701 | 5043CX91K00J |
| A13R4485 | 315-0201-00 | | RES,FXD,FILM:200 OHM,5%,0.25W | 57668 | NTR25J-E200E |
| A13R4486 | 315-0152-00 | | RES,FXD,FILM:1.5K OHM,5%,0.25W | 57668 | NTR25J-E01K5 |
| A13R4487 | 315-0203-00 | | RES,FXD,FILM:20K OHM,5%,0.25W | 57668 | NTR25J-E 20K |
| A13R4488 | 315-0752-00 | | RES,FXD,FILM:7.5K OHM,5%,0.25W | 57668 | NTR25J-E07K5 |
| A13R4489 | 315-0101-00 | | RES,FXD,FILM:100 OHM,5%,0.25W | 57668 | NTR25J-E 100E |
| A13R4490 | 315-0102-00 | | RES,FXD,FILM:1K OHM,5%,0.25W | 57668 | NTR25JE01K0 |
| A13R4491 | 315-0203-00 | | RES,FXD,FILM:20K OHM,5%,0.25W | 57668 | NTR25J-E 20K |
| A13R4492 | 315-0102-00 | | RES,FXD,FILM:1K OHM,5%,0.25W | 57668 | NTR25JE01K0 |
| A13R4493 | 315-0431-00 | | RES,FXD,FILM:430 OHM,5%,0.25W | 19701 | 5043CX430R0J |
| A13R4494 | 315-0911-00 | | RES,FXD,FILM:910 OHM,5%,0.25W | 57668 | NTR25J-E910E |
| A13R4496 | 315-0431-00 | | RES,FXD,FILM:430 OHM,5%,0.25W | 19701 | 5043CX430R0J |
| A13R4498 | 315-0202-00 | | RES,FXD,FILM:2K OHM,5%,0.25W | 57668 | NTR25J-E 2K |

| Component No. | Tektronix Part No. | Serial/Assembly No. Effective Dscont | Name & Description | Mfr. Code | Mfr. Part No. |
|---------------|--------------------|--------------------------------------|--|-----------|----------------|
| A13S4488 | 260-1811-00 | | SWITCH,SLIDE:DPDT,0.5A,125VAC-DC | 82389 | 11P-1137 |
| A13TP4301 | 214-0579-00 | | TERM,TEST POINT:BRS CD PL | 80009 | 214-0579-00 |
| A13TP4303 | 214-0579-00 | | TERM,TEST POINT:BRS CD PL | 80009 | 214-0579-00 |
| A13TP4392 | 214-0579-00 | | TERM,TEST POINT:BRS CD PL | 80009 | 214-0579-00 |
| A13TP4411 | 214-0579-00 | | TERM,TEST POINT:BRS CD PL | 80009 | 214-0579-00 |
| A13TP4412 | 214-0579-00 | | TERM,TEST POINT:BRS CD PL | 80009 | 214-0579-00 |
| A13TP4413 | 214-0579-00 | | TERM,TEST POINT:BRS CD PL | 80009 | 214-0579-00 |
| A13TP4462 | 214-0579-00 | | TERM,TEST POINT:BRS CD PL | 80009 | 214-0579-00 |
| A13TP4468 | 214-0579-00 | | TERM,TEST POINT:BRS CD PL | 80009 | 214-0579-00 |
| A13TP4470 | 214-0579-00 | | TERM,TEST POINT:BRS CD PL | 80009 | 214-0579-00 |
| A13TP4471 | 214-0579-00 | | TERM,TEST POINT:BRS CD PL | 80009 | 214-0579-00 |
| A13U4320 | 155-0011-00 | | MICROCKT,DGTL:CLOCK & CHOP BLANKING | 80009 | 155-0011-00 |
| A13U4340 | 155-0010-00 | | MICROCKT,DGTL:CHOP COUNTER | 80009 | 155-0010-00 |
| A13U4358 | 155-0013-00 | | MICROCKT,DGTL:DC BINARY | 80009 | 155-0013-00 |
| A13U4368 | 155-0013-00 | | MICROCKT,DGTL:DC BINARY | 80009 | 155-0013-00 |
| A13U4412 | 155-0013-00 | | MICROCKT,DGTL:DC BINARY | 80009 | 155-0013-00 |
| A13U4428 | 155-0009-00 | | MICROCKT,DGTL:HORIZ LOCKOUT LGC | 80009 | 155-0009-00 |
| A13U4485 | 155-0012-00 | | MICROCKT,DGTL:Z-AXIS AMPLIFIER | 80009 | 155-0012-00 |
| A13VR4334 | 152-0166-00 | | SEMICON DVC,DI:ZEN,SI,6.2V,5%,400MW,DO-7 | 04713 | SZ11738RL |
| A14 | 670-4776-20 | | CIRCUIT BD ASSY:TRIGGER SELECT | 80009 | 670-4776-20 |
| A14C237 | 283-0221-00 | | CAP,FXD,CER DI:0.47UF,20%,50V | 04222 | SR305C474MAA |
| A14C240 | 290-0183-00 | | CAP,FXD,ELCTLT:1UF,10%,35V | 05397 | T3228105K035AS |
| A14C250 | 290-0525-00 | | CAP,FXD,ELCTLT:4.7UF,20%,50V | 05397 | T368B475M050AS |
| A14C270 | 283-0177-00 | | CAP,FXD,CER DI:1UF,+80-20%,25V | 04222 | SR305E105ZAA |
| A14C440 | 290-0527-00 | | CAP,FXD,ELCTLT:15UF,20%,20V | 05397 | T368B156M020AS |
| A14C447 | 283-0221-00 | | CAP,FXD,CER DI:0.47UF,20%,50V | 04222 | SR305C474MAA |
| A14C450 | 290-0488-00 | | CAP,FXD,ELCTLT:2.2UF,10%,20V | 05397 | T322B225K020AS |
| A14C483 | 283-0260-00 | | CAP,FXD,CER DI:5.6PF,+/-0.25PF,200V | 51642 | 150 200NP0569C |
| A14C483 | 283-0168-00 | | CAP,FXD,CER DI:12PF,5%,100V | 04222 | SR151A12QJAA |
| A14C483 | 283-0159-00 | | CAP,FXD,CER DI:18PF,5%,50V | 04222 | SR155A18QJAA |
| A14C483 | 283-0201-00 | | CAP,FXD,CER DI:27PF,10%,200V (C483 IS SELECTABLE) | 04222 | SR152C27OKAA |
| A14C486 | 281-0775-00 | | CAP,FXD,CER DI:0.1UF,20%,50V | 04222 | MA205E104MAA |
| A14C487 | 283-0111-00 | | CAP,FXD,CER DI:0.1UF,20%,50V | 04222 | SR305C104MAA |
| A14C488 | 281-0775-00 | | CAP,FXD,CER DI:0.1UF,20%,50V | 04222 | MA205E104MAA |
| A14C490 | 283-0339-00 | | CAP,FXD,CER DI:0.22UF,10%,50V | 04222 | SR305C224KAA |
| A14C493 | 283-0260-00 | | CAP,FXD,CER DI:5.6PF,+/-0.25PF,200V | 51642 | 150 200NP0569C |
| A14C493 | 283-0168-00 | | CAP,FXD,CER DI:12PF,5%,100V | 04222 | SR151A12QJAA |
| A14C493 | 283-0159-00 | | CAP,FXD,CER DI:18PF,5%,50V | 04222 | SR155A18QJAA |
| A14C493 | 283-0201-00 | | CAP,FXD,CER DI:27PF,10%,200V (C493 IS SELECTABLE) | 04222 | SR152C27OKAA |
| A14J202 | 131-1003-00 | | CONN,RCPT,ELEC:CKT BD MT,3 PRONG | 80009 | 131-1003-00 |
| A14J203 | 131-1003-00 | | CONN,RCPT,ELEC:CKT BD MT,3 PRONG | 80009 | 131-1003-00 |
| A14J270 | 131-1003-00 | | CONN,RCPT,ELEC:CKT BD MT,3 PRONG | 80009 | 131-1003-00 |
| A14J271 | 131-1003-00 | | CONN,RCPT,ELEC:CKT BD MT,3 PRONG | 80009 | 131-1003-00 |
| A14J402 | 131-1003-00 | | CONN,RCPT,ELEC:CKT BD MT,3 PRONG | 80009 | 131-1003-00 |
| A14J403 | 131-1003-00 | | CONN,RCPT,ELEC:CKT BD MT,3 PRONG | 80009 | 131-1003-00 |
| A14J472 | 131-1003-00 | | CONN,RCPT,ELEC:CKT BD MT,3 PRONG | 80009 | 131-1003-00 |
| A14J473 | 131-1003-00 | | CONN,RCPT,ELEC:CKT BD MT,3 PRONG | 80009 | 131-1003-00 |
| A14J496 | 131-1003-00 | | CONN,RCPT,ELEC:CKT BD MT,3 PRONG | 80009 | 131-1003-00 |
| A14L236 | 108-0734-00 | | COIL,RF:FIXED,163NH | TK1345 | 108-0734-00 |
| A14L238 | 108-0734-00 | | COIL,RF:FIXED,163NH | TK1345 | 108-0734-00 |
| A14L246 | 108-0734-00 | | COIL,RF:FIXED,163NH | TK1345 | 108-0734-00 |
| A14L248 | 108-0734-00 | | COIL,RF:FIXED,163NH | TK1345 | 108-0734-00 |
| A14L436 | 108-0734-00 | | COIL,RF:FIXED,163NH | TK1345 | 108-0734-00 |
| A14L438 | 108-0734-00 | | COIL,RF:FIXED,163NH | TK1345 | 108-0734-00 |
| A14L446 | 108-0734-00 | | COIL,RF:FIXED,163NH | TK1345 | 108-0734-00 |
| A14L448 | 108-0734-00 | | COIL,RF:FIXED,163NH | TK1345 | 108-0734-00 |
| A14L480 | 108-0324-00 | | COIL,RF:FIXED,10MH | 76493 | 70F102A1 |

Replaceable Electrical Parts - 7904A

| Component No. | Tektronix Part No. | Serial/Assembly No. Effective Dscnt | Name & Description | Mfr. Code | Mfr. Part No. |
|---------------|--------------------|-------------------------------------|---|-----------|-----------------|
| A14Q254 | 151-0302-00 | | TRANSISTOR: NPN, SI, TO-18 | 04713 | ST899 |
| A14Q454 | 151-0302-00 | | TRANSISTOR: NPN, SI, TO-18 | 04713 | ST899 |
| A14R201 | 321-0164-00 | | RES, FXD, FILM: 499 OHM, 1%, 0.125W, TC=TO | 19701 | 5033ED499ROF |
| A14R202 | 321-0164-00 | | RES, FXD, FILM: 499 OHM, 1%, 0.125W, TC=TO | 19701 | 5033ED499ROF |
| A14R205 | 315-0103-00 | | RES, FXD, FILM: 10K OHM, 5%, 0.25W | 19701 | 5043CX10K00J |
| A14R208 | 321-0164-00 | | RES, FXD, FILM: 499 OHM, 1%, 0.125W, TC=TO | 19701 | 5033ED499ROF |
| A14R209 | 321-0164-00 | | RES, FXD, FILM: 499 OHM, 1%, 0.125W, TC=TO | 19701 | 5033ED499ROF |
| A14R212 | 325-0053-00 | | RES, FXD, FILM: 50 OHM, 1%, 0.05W, TC=TO | 91637 | CMF50-F50R00F |
| A14R213 | 325-0053-00 | | RES, FXD, FILM: 50 OHM, 1%, 0.05W, TC=TO | 91637 | CMF50-F50R00F |
| A14R214 | 325-0053-00 | | RES, FXD, FILM: 50 OHM, 1%, 0.05W, TC=TO | 91637 | CMF50-F50R00F |
| A14R216 | 325-0053-00 | | RES, FXD, FILM: 50 OHM, 1%, 0.05W, TC=TO | 91637 | CMF50-F50R00F |
| A14R217 | 325-0053-00 | | RES, FXD, FILM: 50 OHM, 1%, 0.05W, TC=TO | 91637 | CMF50-F50R00F |
| A14R218 | 325-0053-00 | | RES, FXD, FILM: 50 OHM, 1%, 0.05W, TC=TO | 91637 | CMF50-F50R00F |
| A14R232 | 321-0202-00 | | RES, FXD, FILM: 1.24K OHM, 1%, 0.125W, TC=TO | 24546 | NA55D1241F |
| A14R233 | 322-0111-00 | | RES, FXD, FILM: 140 OHM, 1%, 0.25W, TC=TO | 91637 | MFF1421G140ROF |
| A14R234 | 322-0170-00 | | RES, FXD, FILM: 576 OHM, 1%, 0.25W, TC=TO | 75042 | CEBTO-5760F |
| A14R235 | 321-0202-00 | | RES, FXD, FILM: 1.24K OHM, 1%, 0.125W, TC=TO | 24546 | NA55D1241F |
| A14R236 | 321-0147-00 | | RES, FXD, FILM: 332 OHM, 1%, 0.125W, TC=TO | 07716 | CEAD332R0F |
| A14R237 | 315-0103-00 | | RES, FXD, FILM: 10K OHM, 5%, 0.25W | 19701 | 5043CX10K00J |
| A14R238 | 321-0155-00 | | RES, FXD, FILM: 402 OHM, 1%, 0.125W, TC=TO | 07716 | CEAD402R0F |
| A14R239 | 321-0085-00 | | RES, FXD, FILM: 75 OHM, 1%, 0.125W, TC=TO | 57668 | CRB14FXE 75 OHM |
| A14R240 | 315-0100-00 | | RES, FXD, FILM: 10 OHM, 5%, 0.25W | 19701 | 5043CX10R00J |
| A14R241 | 322-0114-00 | | RES, FXD, FILM: 150 OHM, 1%, 0.25W, TC=TO | 75042 | CEBTO-1500F |
| A14R242 | 321-0202-00 | | RES, FXD, FILM: 1.24K OHM, 1%, 0.125W, TC=TO | 24546 | NA55D1241F |
| A14R243 | 322-0111-00 | | RES, FXD, FILM: 140 OHM, 1%, 0.25W, TC=TO | 91637 | MFF1421G140ROF |
| A14R244 | 322-0170-00 | | RES, FXD, FILM: 576 OHM, 1%, 0.25W, TC=TO | 75042 | CEBTO-5760F |
| A14R245 | 321-0202-00 | | RES, FXD, FILM: 1.24K OHM, 1%, 0.125W, TC=TO | 24546 | NA55D1241F |
| A14R246 | 321-0147-00 | | RES, FXD, FILM: 332 OHM, 1%, 0.125W, TC=TO | 07716 | CEAD332R0F |
| A14R247 | 315-0103-00 | | RES, FXD, FILM: 10K OHM, 5%, 0.25W | 19701 | 5043CX10K00J |
| A14R248 | 321-0155-00 | | RES, FXD, FILM: 402 OHM, 1%, 0.125W, TC=TO | 07716 | CEAD402R0F |
| A14R250 | 317-0200-00 | | RES, FXD, CMPSN: 20 OHM, 5%, 0.125W | 01121 | BB2005 |
| A14R251 | 321-0218-00 | | RES, FXD, FILM: 1.82K OHM, 1%, 0.125W, TC=TO | 19701 | 5033ED1K82F |
| A14R252 | 321-0242-00 | | RES, FXD, FILM: 3.24K OHM, 1%, 0.125W, TC=TO | 19701 | 5043ED3K240F |
| A14R254 | 315-0102-00 | | RES, FXD, FILM: 1K OHM, 5%, 0.25W | 57668 | NTR25JE01K0 |
| A14R255 | 311-1236-00 | | RES, VAR, NONWV: TRMR, 250 OHM, 0.5W | 32997 | 3386X-T07-251 |
| A14R256 | 321-0062-00 | | RES, FXD, FILM: 43.2 OHM, 0.5%, 0.125W, TC=TO | 57668 | CRB14 FXE 43.2 |
| A14R261 | 321-0178-00 | | RES, FXD, FILM: 698 OHM, 1%, 0.125W, TC=TO | 07716 | CEAD698R0F |
| A14R262 | 315-0510-00 | | RES, FXD, FILM: 51 OHM, 5%, 0.25W | 19701 | 5043CX51R00J |
| A14R263 | 322-0151-00 | | RES, FXD, FILM: 365 OHM, 1%, 0.25W, TC=TO | 24546 | NA60D3650F |
| A14R264 | 321-0201-00 | | RES, FXD, FILM: 1.21K OHM, 1%, 0.125W, TC=TO | 19701 | 5043ED1K210F |
| A14R265 | 321-0285-00 | | RES, FXD, FILM: 9.09K OHM, 1%, 0.125W, TC=TO | 07716 | CEAD90900F |
| A14R270 | 311-1239-00 | | RES, VAR, NONWV: TRMR, 2.5K OHM, 0.5W | 32997 | 3386X-T07-252 |
| A14R271 | 321-0178-00 | | RES, FXD, FILM: 698 OHM, 1%, 0.125W, TC=TO | 07716 | CEAD698R0F |
| A14R272 | 315-0510-00 | | RES, FXD, FILM: 51 OHM, 5%, 0.25W | 19701 | 5043CX51R00J |
| A14R273 | 322-0239-00 | | RES, FXD, FILM: 3.01K OHM, 1%, 0.25W, TC=TO | 75042 | CEBTO-3011F |
| A14R274 | 311-1248-00 | | RES, VAR, NONWV: TRMR, 500 OHM, 0.5W | 32997 | 3386X-T07-501 |
| A14R277 | 317-0510-00 | | RES, FXD, CMPSN: 51 OHM, 5%, 0.125W | 01121 | BB5105 |
| A14R278 | 322-0085-00 | | RES, FXD, FILM: 75.0 OHM, 1%, 0.25W, TC=TO | 75042 | CEBTD-75R00F |
| A14R279 | 311-1936-00 | | RES, VAR, NONWV: TRMR, 50 OHM, 20%, 0.5W | 32997 | 3386X-T07-500 |
| A14R280 | 317-0510-00 | | RES, FXD, CMPSN: 51 OHM, 5%, 0.125W | 01121 | BB5105 |
| A14R401 | 321-0164-00 | | RES, FXD, FILM: 499 OHM, 1%, 0.125W, TC=TO | 19701 | 5033ED499ROF |
| A14R402 | 321-0164-00 | | RES, FXD, FILM: 499 OHM, 1%, 0.125W, TC=TO | 19701 | 5033ED499ROF |
| A14R405 | 315-0103-00 | | RES, FXD, FILM: 10K OHM, 5%, 0.25W | 19701 | 5043CX10K00J |
| A14R408 | 321-0164-00 | | RES, FXD, FILM: 499 OHM, 1%, 0.125W, TC=TO | 19701 | 5033ED499ROF |
| A14R409 | 321-0164-00 | | RES, FXD, FILM: 499 OHM, 1%, 0.125W, TC=TO | 19701 | 5033ED499ROF |
| A14R412 | 325-0053-00 | | RES, FXD, FILM: 50 OHM, 1%, 0.05W, TC=TO | 91637 | CMF50-F50R00F |
| A14R413 | 325-0053-00 | | RES, FXD, FILM: 50 OHM, 1%, 0.05W, TC=TO | 91637 | CMF50-F50R00F |
| A14R414 | 325-0053-00 | | RES, FXD, FILM: 50 OHM, 1%, 0.05W, TC=TO | 91637 | CMF50-F50R00F |

| Component No. | Tektronix Part No. | Serial/Assembly No. Effective Dscont | Name & Description | Mfr. Code | Mfr. Part No. |
|---------------|--------------------|--------------------------------------|---|-----------|------------------|
| A14R416 | 325-0053-00 | | RES,FXD,FILM:50 OHM,1%,0.05W,TC=TO | 91637 | CMF50-F50R00F |
| A14R417 | 325-0053-00 | | RES,FXD,FILM:50 OHM,1%,0.05W,TC=TO | 91637 | CMF50-F50R00F |
| A14R418 | 325-0053-00 | | RES,FXD,FILM:50 OHM,1%,0.05W,TC=TO | 91637 | CMF50-F50R00F |
| A14R419 | 321-0143-00 | | RES,FXD,FILM:301 OHM,1%,0.125W,TC=TO | 07716 | CEAD301ROF |
| A14R420 | 321-0126-00 | | RES,FXD,FILM:200 OHM,1%,0.125W,TC=TO | 19701 | 5033ED200ROF |
| A14R425 | 321-0143-00 | | RES,FXD,FILM:301 OHM,1%,0.125W,TC=TO | 07716 | CEAD301ROF |
| A14R426 | 321-0126-00 | | RES,FXD,FILM:200 OHM,1%,0.125W,TC=TO | 19701 | 5033ED200ROF |
| A14R432 | 321-0202-00 | | RES,FXD,FILM:1.24K OHM,1%,0.125W,TC=TO | 24546 | NA55D1241F |
| A14R433 | 322-0111-00 | | RES,FXD,FILM:140 OHM,1%,0.25W,TC=TO | 91637 | MFF1421G140ROF |
| A14R434 | 322-0170-00 | | RES,FXD,FILM:576 OHM,1%,0.25W,TC=TO | 75042 | CEBT0-5760F |
| A14R435 | 321-0202-00 | | RES,FXD,FILM:1.24K OHM,1%,0.125W,TC=TO | 24546 | NA55D1241F |
| A14R436 | 321-0147-00 | | RES,FXD,FILM:332 OHM,1%,0.125W,TC=TO | 07716 | CEAD332ROF |
| A14R437 | 315-0103-00 | | RES,FXD,FILM:10K OHM,5%,0.25W | 19701 | 5043CX10K00J |
| A14R438 | 321-0155-00 | | RES,FXD,FILM:402 OHM,1%,0.125W,TC=TO | 07716 | CEAD402ROF |
| A14R439 | 322-0114-00 | | RES,FXD,FILM:150 OHM,1%,0.25W,TC=TO | 75042 | CEBT0-1500F |
| A14R440 | 317-0200-00 | | RES,FXD,CMPSN:20 OHM,5%,0.125W | 01121 | BB2005 |
| A14R441 | 321-0085-00 | | RES,FXD,FILM:75 OHM,1%,0.125W,TC=TO | 57668 | CRB14FXE 75 OHM |
| A14R442 | 321-0202-00 | | RES,FXD,FILM:1.24K OHM,1%,0.125W,TC=TO | 24546 | NA55D1241F |
| A14R443 | 322-0111-00 | | RES,FXD,FILM:140 OHM,1%,0.25W,TC=TO | 91637 | MFF1421G140ROF |
| A14R444 | 322-0170-00 | | RES,FXD,FILM:576 OHM,1%,0.25W,TC=TO | 75042 | CEBT0-5760F |
| A14R445 | 321-0202-00 | | RES,FXD,FILM:1.24K OHM,1%,0.125W,TC=TO | 24546 | NA55D1241F |
| A14R446 | 321-0147-00 | | RES,FXD,FILM:332 OHM,1%,0.125W,TC=TO | 07716 | CEAD332ROF |
| A14R447 | 315-0103-00 | | RES,FXD,FILM:10K OHM,5%,0.25W | 19701 | 5043CX10K00J |
| A14R448 | 321-0155-00 | | RES,FXD,FILM:402 OHM,1%,0.125W,TC=TO | 07716 | CEAD402ROF |
| A14R451 | 321-0218-00 | | RES,FXD,FILM:1.82K OHM,1%,0.125W,TC=TO | 19701 | 5033ED1K82F |
| A14R452 | 321-0242-00 | | RES,FXD,FILM:3.24K OHM,1%,0.125W,TC=TO | 19701 | 5043ED3K240F |
| A14R454 | 315-0102-00 | | RES,FXD,FILM:1K OHM,5%,0.25W | 57668 | NTR25JE01K0 |
| A14R455 | 311-1236-00 | | RES,VAR,NONNW:TRMR,250 OHM,0.5W | 32997 | 3386X-T07-251 |
| A14R456 | 321-0062-00 | | RES,FXD,FILM:43.2 OHM,0.5%,0.125W,TC=TO | 57668 | CRB14 FXE 43.2 |
| A14R462 | 322-0151-00 | | RES,FXD,FILM:365 OHM,1%,0.25W,TC=TO | 24546 | NA60D3650F |
| A14R464 | 321-0201-00 | | RES,FXD,FILM:1.21K OHM,1%,0.125W,TC=TO | 19701 | 5043ED1K210F |
| A14R465 | 321-0285-00 | | RES,FXD,FILM:9.09K OHM,1%,0.125W,TC=TO | 07716 | CEAD90900F |
| A14R473 | 322-0239-00 | | RES,FXD,FILM:3.01K OHM,1%,0.25W,TC=TO | 75042 | CEBT0-3011F |
| A14R474 | 311-1248-00 | | RES,VAR,NONNW:TRMR,500 OHM,0.5W | 32997 | 3386X-T07-501 |
| A14R476 | 317-0510-00 | | RES,FXD,CMPSN:51 OHM,5%,0.125W | 01121 | BB5105 |
| A14R477 | 317-0510-00 | | RES,FXD,CMPSN:51 OHM,5%,0.125W | 01121 | BB5105 |
| A14R478 | 322-0085-00 | | RES,FXD,FILM:75.0 OHM,1%,0.25W,TC=TO | 75042 | CEBT0-75R00F |
| A14R479 | 311-1936-00 | | RES,VAR,NONNW:TRMR,50 OHM,20%,0.5W | 32997 | 3386X-T07-500 |
| A14R480 | 311-1237-00 | | RES,VAR,NONNW:1K OHM,10%,0.50W | 32997 | 3386X-DY6-102 |
| A14R481 | 321-0179-00 | | RES,FXD,FILM:715 OHM,1%,0.125W,TC=TO | 07716 | CEAD715ROF |
| A14R482 | 321-0182-00 | | RES,FXD,FILM:768 OHM,1%,0.125W,TC=TO | 07716 | CEAD768ROF |
| A14R483 | 317-0200-00 | | RES,FXD,CMPSN:20 OHM,5%,0.125W | 01121 | BB2005 |
| A14R484 | 315-0510-00 | | RES,FXD,FILM:51 OHM,5%,0.25W | 19701 | 5043CX51R00J |
| A14R485 | 311-1936-00 | | RES,VAR,NONNW:TRMR,50 OHM,20%,0.5W | 32997 | 3386X-T07-500 |
| A14R486 | 325-0026-00 | | RES,FXD,FILM:180 OHM,1%,0.05W,TC=T9,MET | 91637 | CMF50-C180ROF |
| A14R490 | 311-1237-00 | | RES,VAR,NONNW:1K OHM,10%,0.50W | 32997 | 3386X-DY6-102 |
| A14R491 | 321-0179-00 | | RES,FXD,FILM:715 OHM,1%,0.125W,TC=TO | 07716 | CEAD715ROF |
| A14R492 | 321-0182-00 | | RES,FXD,FILM:768 OHM,1%,0.125W,TC=TO | 07716 | CEAD768ROF |
| A14R493 | 317-0200-00 | | RES,FXD,CMPSN:20 OHM,5%,0.125W | 01121 | BB2005 |
| A14R494 | 315-0510-00 | | RES,FXD,FILM:51 OHM,5%,0.25W | 19701 | 5043CX51R00J |
| A14R495 | 322-0145-00 | | RES,FXD,FILM:316 OHM,1%,0.25W,TC=TO | 75042 | CEBT0-3160F |
| A14R496 | 325-0026-00 | | RES,FXD,FILM:180 OHM,1%,0.05W,TC=T9,MET | 91637 | CMF50-C180ROF |
| A14R497 | 322-0175-00 | | RES,FXD,FILM:649 OHM,1%,0.25W,TC=TO | 75042 | CEBT0-6490F |
| A14R498 | 321-0143-00 | | RES,FXD,FILM:301 OHM,1%,0.125W,TC=TO | 07716 | CEAD301ROF |
| A14R499 | 315-0510-00 | | RES,FXD,FILM:51 OHM,5%,0.25W | 19701 | 5043CX51R00J |
| A14U232 | 155-0173-00 | | MICROCKT,LINER:VERTICAL CHANNEL SWITCH | 80009 | 155-0173-00 |
| A14U252 | 156-0158-00 | | MICROCKT,LINER:BIPOLAR,DUAL OPNL AMPL | 04713 | MC1458P1/MC1458U |
| A14U274 | 155-0175-00 | | MICROCKT,LINER:TRIGGER AMPLIFIER | 80009 | 155-0175-00 |

Replaceable Electrical Parts - 7904A

| Component No. | Tektronix Part No. | Serial/Assembly No. Effective | Discont | Name & Description | Mfr. Code | Mfr. Part No. |
|---------------|--------------------|-------------------------------|---------|---|-----------|------------------|
| A14U402 | 156-0730-02 | | | MICROCKT,DGTL:QUAD 2-INP NOR BFR,SCRN | 80009 | 156-0730-02 |
| A14U432 | 155-0173-00 | | | MICROCKT,LINER:VERTICAL CHANNEL SWITCH | 80009 | 155-0173-00 |
| A14U452 | 156-0158-00 | | | MICROCKT,LINER:BIPOLAR,DUAL OPNL AMPL | 04713 | MC1458P1/MC1458U |
| A14U474 | 155-0175-00 | | | MICROCKT,LINER:TRIGGER AMPLIFIER | 80009 | 155-0175-00 |
| A14U492 | 155-0175-00 | | | MICROCKT,LINER:TRIGGER AMPLIFIER | 80009 | 155-0175-00 |
| A14VR237 | 153-0067-00 | | | SEMICON DVC SE:ZENER,PAIR | 80009 | 153-0067-00 |
| A14VR247 | 153-0067-00 | | | SEMICON DVC SE:ZENER,PAIR | 80009 | 153-0067-00 |
| A14VR437 | 153-0067-00 | | | SEMICON DVC SE:ZENER,PAIR | 80009 | 153-0067-00 |
| A14VR447 | 153-0067-00 | | | SEMICON DVC SE:ZENER,PAIR | 80009 | 153-0067-00 |
| A15 | 672-0572-00 | B010100 | B029999 | CIRCUIT BD ASSY:READOUT PROTECTION #1 | 80009 | 672-0572-00 |
| A15 | 672-0572-01 | B030000 | B031800 | CIRCUIT BD ASSY:READOUT PROTECTION #1 | 80009 | 672-0572-01 |
| A15 | 672-0572-02 | B031801 | B041951 | CIRCUIT BD ASSY:READOUT PROTECTION #1 | 80009 | 672-0572-02 |
| A15 | 672-0572-05 | B041952 | B042193 | CIRCUIT BD ASSY:READOUT PROTECTION #1 | 80009 | 672-0572-05 |
| A15 | 672-0572-06 | B042194 | B042314 | CIRCUIT BD ASSY:READOUT PROTECTION #1 | 80009 | 672-0572-06 |
| A15 | 672-0572-07 | B042315 | B042481 | CIRCUIT BD ASSY:READOUT PRO #1 | 80009 | 672-0572-07 |
| A15 | 672-0572-08 | B042482 | | CIRCUIT BD ASSY:READOUT PRO #1 (INCLUDES A15A1,A27 ASSEMBLIES) | 80009 | 672-0572-08 |
| A15A1 | 670-1900-06 | B010100 | B029999 | CIRCUIT BD ASSY:READOUT (PART OF 672-0572-XX) | 80009 | 670-1900-06 |
| A15A1 | 670-8620-00 | B030000 | B031800 | CIRCUIT BD ASSY:READOUT (PART OF 672-0572-XX) | 80009 | 670-8620-00 |
| A15A1 | 670-8620-01 | B031801 | B041951 | CIRCUIT BD ASSY:READOUT | 80009 | 670-8620-01 |
| A15A1 | 670-8620-04 | B041952 | B042193 | CIRCUIT BD ASSY:READOUT (PART OF 672-0572-XX) | 80009 | 670-8620-04 |
| A15A1 | 670-8620-05 | B042194 | B042314 | CIRCUIT BD ASSY:READOUT (PART OF 672-0572-XX) | 80009 | 670-8620-05 |
| A15A1 | 670-8620-06 | B042315 | B042481 | CIRCUIT BD ASSY:READOUT | 80009 | 670-8620-06 |
| A15A1 | 670-8620-07 | B042482 | | CIRCUIT BD ASSY:READOUT | 80009 | 670-8620-07 |
| A15A1C2101 | 283-0004-00 | B010100 | B029999 | CAP,FXD,CER DI:0.02UF,+80-20%,150V | 59660 | 855-558Z5V0203Z |
| A15A1C2101 | 281-0774-00 | B030000 | | CAP,FXD,CER DI:0.022MFD,20%,100V | 04222 | MA201E223MAA |
| A15A1C2105 | 283-0108-00 | B042194 | | CAP,FXD,CER DI:220PF,10%,200V | 04222 | SR152A221KAA |
| A15A1C2109 | 283-0003-00 | B010100 | B029999 | CAP,FXD,CER DI:0.01UF,+80-20%,150V | 59821 | D103Z40Z5UJDCX |
| A15A1C2109 | 281-0773-00 | B030000 | | CAP,FXD,CER DI:0.01UF,10%,100V | 04222 | MA201C103KAA |
| A15A1C2112 | 283-0077-00 | B010100 | B029999 | CAP,FXD,CER DI:330PF,5%,500V | 59660 | 831-500B331J |
| A15A1C2112 | 281-0767-00 | B030000 | | CAP,FXD,CER DI:330PF,20%,100V | 04222 | MA106C331MAA |
| A15A1C2115 | 290-0782-00 | B010100 | B029999 | CAP,FXD,ELCTLT:4.7UF,+75-20%,35VDC | 55680 | ULB1V4R7TAAANA |
| A15A1C2115 | 290-0804-00 | B030000 | | CAP,FXD,ELCTLT:10UF,+50-20%,25V | 55680 | ULB1E100TAAANA |
| A15A1C2117 | 290-0782-00 | B010100 | B029999 | CAP,FXD,ELCTLT:4.7UF,+75-20%,35VDC | 55680 | ULB1V4R7TAAANA |
| A15A1C2117 | 290-0920-00 | B030000 | | CAP,FXD,ELCTLT:33UF,+50-20%,35VDC | 55680 | UVX1H330MAA |
| A15A1C2118 | 290-0804-00 | B030000 | | CAP,FXD,ELCTLT:10UF,+50-20%,25V | 55680 | ULB1E100TAAANA |
| A15A1C2119 | 290-0782-00 | B010100 | B029999 | CAP,FXD,ELCTLT:4.7UF,+75-20%,35VDC | 55680 | ULB1V4R7TAAANA |
| A15A1C2120 | 281-0862-00 | B030000 | | CAP,FXD,CER DI:0.001UF,+80-20%,100V | 04222 | MA101C10ZMAA |
| A15A1C2121 | 283-0594-00 | B010100 | B029999 | CAP,FXD,MICA DI:0.001UF,1%,100V | 00853 | D151F102FO |
| A15A1C2121 | 281-0773-00 | B030000 | | CAP,FXD,CER DI:0.01UF,10%,100V | 04222 | MA201C103KAA |
| A15A1C2127 | 281-0773-00 | B030000 | B042481 | CAP,FXD,CER DI:0.01UF,10%,100V | 04222 | MA201C103KAA |
| A15A1C2135 | 285-0698-00 | | | CAP,FXD,PLASTIC:0.0082UF,5%,100V | 80009 | 285-0698-00 |
| A15A1C2140 | 283-0103-00 | B010100 | B029999 | CAP,FXD,CER DI:180PF,5%,500V | 59821 | 2DDH73L181J |
| A15A1C2141 | 281-0767-00 | B041952 | | CAP,FXD,CER DI:330PF,20%,100V | 04222 | MA106C331MAA |
| A15A1C2144 | 281-0810-00 | | | CAP,FXD,CER DI:5.6PF,+/-0.5PF,100V | 04222 | MA101A5R6DAA |
| A15A1C2145 | 290-0782-00 | B010100 | B029999 | CAP,FXD,ELCTLT:4.7UF,+75-20%,35VDC | 55680 | ULB1V4R7TAAANA |
| A15A1C2154 | 283-0630-00 | B030000 | | CAP,FXD,MICA DI:110PF,1%,100V | 00853 | D155F111FO |
| A15A1C2154 | 283-0728-00 | B030000 | | CAP,FXD,MICA DI:120PF,1%,500V | 00853 | D155F121FO |
| A15A1C2154 | 283-0796-00 | B030000 | | CAP,FXD,MICA DI:100PF,5%,500V (C2154 IS SELECTABLE) | 00853 | D105F101JO |
| A15A1C2155 | 283-0103-00 | B010100 | B029999 | CAP,FXD,CER DI:180PF,5%,500V | 59821 | 2DDH73L181J |
| A15A1C2155 | 281-0158-00 | B030000 | | CAP,VAR,CER DI:7-45PF,100WDC SUBMIN CER | 59660 | 518-006 G 7-45 |
| A15A1C2157 | 281-0773-00 | B030000 | | CAP,FXD,CER DI:0.01UF,10%,100V | 04222 | MA201C103KAA |
| A15A1C2161 | 281-0765-00 | B030000 | B042481 | CAP,FXD,CER DI:100PF,5%,100V | 04222 | MA101A101JAA |
| A15A1C2161 | 281-0812-00 | B042482 | | CAP,FXD,CER DI:1000PF,10%,100V | 04222 | MA101C102KAA |
| A15A1C2180 | 281-0773-00 | B030000 | | CAP,FXD,CER DI:0.01UF,10%,100V | 04222 | MA201C103KAA |

| Component No. | Tektronix Part No. | Serial/Assembly No. Effective | Discont | Name & Description | Mfr. Code | Mfr. Part No. |
|---------------|--------------------|-------------------------------|---------|--|-----------|------------------|
| A15A1C2183 | 283-0032-00 | B010100 | B029999 | CAP,FXD,CER DI:470PF,5%,500V | 59660 | 831-000-Z5E0471J |
| A15A1C2183 | 281-0788-00 | B030000 | | CAP,FXD,CER DI:470PF,10%,100V | 04222 | SA102C471KAA |
| A15A1C2185 | 283-0004-00 | B010100 | B029999 | CAP,FXD,CER DI:0.02UF,+80-20%,150V | 59660 | 855-558Z5V0203Z |
| A15A1C2185 | 281-0774-00 | B030000 | | CAP,FXD,CER DI:0.022MFO,20%,100V | 04222 | MA201E223MAA |
| A15A1C2186 | 281-0773-00 | B030000 | | CAP,FXD,CER DI:0.01UF,10%,100V | 04222 | MA201C103KAA |
| A15A1C2187 | 281-0862-00 | B030000 | | CAP,FXD,CER DI:0.001UF,+80-20%,100V | 04222 | MA101C102MAA |
| A15A1C2190 | 281-0773-00 | B030000 | | CAP,FXD,CER DI:0.01UF,10%,100V | 04222 | MA201C103KAA |
| A15A1C2201 | 283-0114-00 | B030000 | | CAP,FXD,CER DI:1500PF,5%,200V | 59660 | 805-534-Y5D0152J |
| A15A1C2202 | 281-0773-00 | B030000 | | CAP,FXD,CER DI:0.01UF,10%,100V | 04222 | MA201C103KAA |
| A15A1C2203 | 281-0773-00 | B030000 | | CAP,FXD,CER DI:0.01UF,10%,100V | 04222 | MA201C103KAA |
| A15A1C2204 | 281-0773-00 | B030000 | | CAP,FXD,CER DI:0.01UF,10%,100V | 04222 | MA201C103KAA |
| A15A1C2211 | 281-0762-00 | B030000 | | CAP,FXD,CER DI:27PF,20%,100V | 04222 | MA101A270MAA |
| A15A1C2212 | 283-0666-00 | B030000 | | CAP,FXD,MICA DI:890PF,2%,100V | 00853 | D151F891G0 |
| A15A1C2213 | 283-0640-00 | B030000 | | CAP,FXD,MICA DI:160PF,1%,500V | 00853 | D155F161F0 |
| A15A1C2214 | 283-0032-00 | B010100 | B029999 | CAP,FXD,CER DI:470PF,5%,500V | 59660 | 831-000-Z5E0471J |
| A15A1C2221 | 281-0788-00 | B030000 | | CAP,FXD,CER DI:470PF,10%,100V | 04222 | SA102C471KAA |
| A15A1C2239 | 281-0788-00 | B030000 | B042481 | CAP,FXD,CER DI:470PF,10%,100V | 04222 | SA102C471KAA |
| A15A1C2239 | 281-0812-00 | B042482 | | CAP,FXD,CER DI:1000PF,10%,100V | 04222 | MA101C102KAA |
| A15A1C2242 | 283-0000-00 | B010100 | B029999 | CAP,FXD,CER DI:0.001UF,+100-0%,500V | 59660 | 831-610-Y5U0102P |
| A15A1C2243 | 281-0773-00 | B030000 | | CAP,FXD,CER DI:0.01UF,10%,100V | 04222 | MA201C103KAA |
| A15A1C2244 | 283-0004-00 | B010100 | B029999 | CAP,FXD,CER DI:0.02UF,+80-20%,150V | 59660 | 855-558Z5V0203Z |
| A15A1C2244 | 281-0774-00 | B030000 | | CAP,FXD,CER DI:0.022MFD,20%,100V | 04222 | MA201E223MAA |
| A15A1C2245 | 281-0773-00 | B030000 | | CAP,FXD,CER DI:0.01UF,10%,100V | 04222 | MA201C103KAA |
| A15A1C2246 | 281-0773-00 | B030000 | | CAP,FXD,CER DI:0.01UF,10%,100V | 04222 | MA201C103KAA |
| A15A1C2251 | 281-0773-00 | B030000 | | CAP,FXD,CER DI:0.01UF,10%,100V | 04222 | MA201C103KAA |
| A15A1C2255 | 283-0000-00 | B010100 | B029999 | CAP,FXD,CER DI:0.001UF,+100-0%,500V | 59660 | 831-610-Y5U0102P |
| A15A1C2259 | 281-0762-00 | B041952 | | CAP,FXD,CER DI:27PF,20%,100V | 04222 | MA101A270MAA |
| A15A1C2259 | 281-0759-00 | B042194 | | CAP,FXD,CER DI:22PF,10%,100V | 04222 | MA101A220KAA |
| A15A1C2259 | 281-0763-00 | B042194 | | CAP,FXD,CER DI:47PF,10%,100V | 04222 | MA101A470KAA |
| A15A1C2259 | 281-0797-00 | B042194 | | CAP,FXD,CER DI:15PF,10%,100V | 04222 | SA106A150KAA |
| A15A1C2259 | 281-0819-00 | B042194 | | CAP,FXD,CER DI:33 PF,5%,50V (C2259 IS SELECTABLE) | 04222 | GC105A330J |
| A15A1C2263 | 281-0773-00 | B030000 | | CAP,FXD,CER DI:0.01UF,10%,100V | 04222 | MA201C103KAA |
| A15A1C2276 | 281-0762-00 | B030000 | | CAP,FXD,CER DI:27PF,20%,100V | 04222 | MA101A270MAA |
| A15A1C2277 | 283-0666-00 | B030000 | | CAP,FXD,MICA DI:890PF,2%,100V | 00853 | D151F891G0 |
| A15A1C2279 | 283-0640-00 | B030000 | | CAP,FXD,MICA DI:160PF,1%,500V | 00853 | D155F161F0 |
| A15A1C2281 | 283-0054-00 | | | CAP,FXD,CER DI:150PF,5%,200V | 59660 | 855-535 U2J0151J |
| A15A1C2284 | 283-0251-00 | | | CAP,FXD,CER DI:87 PF,5%,100V | 04222 | 3418 100A 870J |
| A15A1C2297 | 281-0762-00 | B041952 | | CAP,FXD,CER DI:27PF,20%,100V | 04222 | MA101A270MAA |
| A15A1C2297 | 281-0759-00 | B042194 | | CAP,FXD,CER DI:22PF,10%,100V | 04222 | MA101A220KAA |
| A15A1C2297 | 281-0763-00 | B042194 | | CAP,FXD,CER DI:47PF,10%,100V | 04222 | MA101A470KAA |
| A15A1C2297 | 281-0797-00 | B042194 | | CAP,FXD,CER DI:15PF,10%,100V | 04222 | SA1D6A150KAA |
| A15A1C2297 | 281-0819-00 | B042194 | | CAP,FXD,CER DI:33 PF,5%,50V (C2297 IS SELECTABLE) | 04222 | GC105A330J |
| A15A1C3440 | 281-0816-00 | B031801 | | CAP,FXD,CER DI:82 PF,5%,100V | 04222 | MA106A820JAA |
| A15A1CR2124 | 152-0141-02 | | | SEMICON DVC,DI:SW,S1,30V,150MA,30V,DO-35 | 03508 | DA2527 (1N4152) |
| A15A1CR2125 | 152-0141-02 | | | SEMICON DVC,DI:SW,S1,30V,150MA,30V,DO-35 | 03508 | DA2527 (1N4152) |
| A15A1CR2127 | 152-0141-02 | B010100 | B029999 | SEMICON DVC,DI:SW,S1,30V,150MA,30V,DO-35 | 03508 | DA2527 (1N4152) |
| A15A1CR2137 | 152-0141-02 | B030000 | | SEMICON DVC,DI:SW,S1,30V,150MA,30V,DO-35 | 03508 | DA2527 (1N4152) |
| A15A1CR2139 | 152-0141-02 | B030000 | | SEMICON DVC,DI:SW,S1,30V,150MA,30V,DO-35 | 03508 | DA2527 (1N4152) |
| A15A1CR2140 | 152-0141-02 | B010100 | B029999 | SEMICON DVC,DI:SW,S1,30V,150MA,30V,DO-35 | 03508 | DA2527 (1N4152) |
| A15A1CR2141 | 152-0141-02 | B010100 | B029999 | SEMICON DVC,DI:SW,S1,30V,150MA,30V,DO-35 | 03508 | DA2527 (1N4152) |
| A15A1CR2142 | 152-0141-02 | B010100 | B029999 | SEMICON DVC,DI:SW,S1,30V,150MA,30V,DO-35 | 03508 | DA2527 (1N4152) |
| A15A1CR2145 | 152-0141-02 | | | SEMICON DVC,DI:SW,S1,30V,150MA,30V,DO-35 | 03508 | DA2527 (1N4152) |
| A15A1CR2146 | 152-0141-02 | | | SEMICON DVC,DI:SW,S1,30V,150MA,30V,DO-35 | 03508 | DA2527 (1N4152) |
| A15A1CR2153 | 152-0141-02 | B030000 | | SEMICON DVC,DI:SW,S1,30V,150MA,30V,DO-35 | 03508 | DA2527 (1N4152) |
| A15A1CR2156 | 152-0141-02 | B010100 | B029999 | SEMICON DVC,DI:SW,S1,30V,150MA,30V,DO-35 | 03508 | DA2527 (1N4152) |
| A15A1CR2157 | 152-0141-02 | B010100 | B042314 | SEMICON DVC,DI:SW,S1,30V,150MA,30V,DO-35 | 03508 | DA2527 (1N4152) |

Replaceable Electrical Parts - 7904A

| Component No. | Tektronix Part No. | Serial/Assembly No. Effective | Dscont | Name & Description | Mfr. Code | Mfr. Part No. |
|---------------|--------------------|-------------------------------|---------|---|-----------|-----------------|
| A15A1CR2157 | 152-0322-00 | B042315 | | SEMICON DVC,DI: SCHOTTKY,SI,15V,1.2PF,DO-35 | 50434 | 5082-2672 |
| A15A1CR2160 | 152-0141-02 | B030000 | | SEMICON DVC,DI:SW,SI,30V,150MA,30V,DO-35 | 03508 | DA2527 (1N4152) |
| A15A1CR2161 | 152-0141-02 | B030000 | B042481 | SEMICON DVC,DI:SW,SI,30V,150MA,30V,DO-35 | 03508 | DA2527 (1N4152) |
| A15A1CR2161 | 152-0322-00 | B042482 | | SEMICON DVC,DI: SCHOTTKY,SI,15V,1.2PF,DO-35 | 50434 | 5082-2672 |
| A15A1CR2162 | 152-0141-02 | | | SEMICON DVC,DI:SW,SI,30V,150MA,30V,DO-35 | 03508 | DA2527 (1N4152) |
| A15A1CR2163 | 152-0141-02 | | | SEMICON DVC,DI:SW,SI,30V,150MA,30V,DO-35 | 03508 | DA2527 (1N4152) |
| A15A1CR2166 | 152-0141-02 | | | SEMICON DVC,DI:SW,SI,30V,150MA,30V,DO-35 | 03508 | DA2527 (1N4152) |
| A15A1CR2167 | 152-0141-02 | | | SEMICON DVC,DI:SW,SI,30V,150MA,30V,DO-35 | 03508 | DA2527 (1N4152) |
| A15A1CR2170 | 152-0141-02 | | | SEMICON DVC,DI:SW,SI,30V,150MA,30V,DO-35 | 03508 | DA2527 (1N4152) |
| A15A1CR2171 | 152-0141-02 | | | SEMICON DVC,DI:SW,SI,30V,150MA,30V,DO-35 | 03508 | DA2527 (1N4152) |
| A15A1CR2174 | 152-0141-02 | | | SEMICON DVC,DI:SW,SI,30V,150MA,30V,DO-35 | 03508 | DA2527 (1N4152) |
| A15A1CR2175 | 152-0141-02 | | | SEMICON DVC,DI:SW,SI,30V,150MA,30V,DO-35 | 03508 | DA2527 (1N4152) |
| A15A1CR2187 | 152-0141-02 | B030000 | | SEMICON DVC,DI:SW,SI,30V,150MA,30V,DO-35 | 03508 | DA2527 (1N4152) |
| A15A1CR2192 | 152-0141-02 | B010100 | B029999 | SEMICON DVC,DI:SW,SI,30V,150MA,30V,DO-35 | 03508 | DA2527 (1N4152) |
| A15A1CR2193 | 152-0141-02 | B010100 | B029999 | SEMICON DVC,DI:SW,SI,30V,150MA,30V,DO-35 | 03508 | DA2527 (1N4152) |
| A15A1CR2196 | 152-0141-02 | B010100 | B029999 | SEMICON DVC,DI:SW,SI,30V,150MA,30V,DO-35 | 03508 | DA2527 (1N4152) |
| A15A1CR2198 | 152-0141-02 | B010100 | B029999 | SEMICON DVC,DI:SW,SI,30V,150MA,30V,DO-35 | 03508 | DA2527 (1N4152) |
| A15A1CR2226 | 152-0141-02 | B010100 | B029999 | SEMICON DVC,DI:SW,SI,30V,150MA,30V,DO-35 | 03508 | DA2527 (1N4152) |
| A15A1CR2229 | 152-0141-02 | B030000 | | SEMICON DVC,DI:SW,SI,30V,150MA,30V,DO-35 | 03508 | DA2527 (1N4152) |
| A15A1CR2267 | 152-0141-02 | B030000 | | SEMICON DVC,DI:SW,SI,30V,150MA,30V,DO-35 | 03508 | DA2527 (1N4152) |
| A15A1CR2270 | 152-0141-02 | B030000 | | SEMICON DVC,DI:SW,SI,30V,150MA,30V,DO-35 | 03508 | DA2527 (1N4152) |
| A15A1CR2271 | 152-0141-02 | B030000 | | SEMICON DVC,DI:SW,SI,30V,150MA,30V,DO-35 | 03508 | DA2527 (1N4152) |
| A15A1E2132 | 276-0532-00 | B0318D1 | | SHLD BEAD,ELEK:FERRITE | 02114 | 56-590-65/4A6 |
| A15A1J2132 | 131-1003-00 | | | CONN,RCPT,ELEC:CKT BD MT,3 PRONG | 80009 | 131-1003-00 |
| A15A1J2138 | 131-1003-00 | | | CONN,RCPT,ELEC:CKT BD MT,3 PRONG | 80009 | 131-1003-00 |
| A15A1J2139 | 131-1003-00 | | | CONN,RCPT,ELEC:CKT BD MT,3 PRONG | 80009 | 131-1003-00 |
| A15A1J2192 | 131-1003-00 | | | CONN,RCPT,ELEC:CKT BD MT,3 PRONG | 80009 | 131-1003-00 |
| A15A1J2296 | 131-1003-00 | | | CONN,RCPT,ELEC:CKT BD MT,3 PRONG | 80009 | 131-1003-00 |
| A15A1J2299 | 131-1003-00 | | | CONN,RCPT,ELEC:CKT BD MT,3 PRONG | 80009 | 131-1003-00 |
| A15A1L2212 | 108-0800-00 | B030000 | | COIL,RF:FIXED,820MH | 04072 | 9230-90 |
| A15A1L2277 | 108-0800-00 | B030000 | | COIL,RF:FIXED,820MH | 04072 | 9230-90 |
| A15A1L2283 | 108-0331-00 | B010100 | B029999 | COIL,RF:FIXED,758NH | TK1345 | 108-0331-00 |
| A15A1P2165 | 131-0608-00 | | | TERMINAL,PIN:0.365 L X 0.025 BRZ GLD PL (QUANTITY OF 10) | 22526 | 48283-036 |
| A15A1P2166 | 131-0608-00 | | | TERMINAL,PIN:0.365 L X 0.025 BRZ GLD PL (QUANTITY OF 10) | 22526 | 48283-036 |
| A15A1P2171 | 131-0608-00 | | | TERMINAL,PIN:0.365 L X 0.025 BRZ GLD PL (QUANTITY OF 10) | 22526 | 48283-036 |
| A15A1P2250 | 131-0608-00 | | | TERMINAL,PIN:0.365 L X 0.025 BRZ GLD PL (QUANTITY OF 10) | 22526 | 48283-036 |
| A15A1Q2108 | 151-0223-00 | | | TRANSISTOR:NPN,SI,625MW,TO-92 | 80009 | 151-0223-00 |
| A15A1Q2112 | 151-0221-00 | B010100 | B042193 | TRANSISTOR:PMP,SI,TO-92 | 80009 | 151-0221-00 |
| A15A1Q2112 | 151-0188-00 | B042194 | | TRANSISTOR:PMP,SI,TO-92 | 80009 | 151-0188-00 |
| A15A1Q2127 | 151-0190-00 | B042482 | | TRANSISTOR:NPN,SI,TO-92 | 80009 | 151-0190-00 |
| A15A1Q2131 | 151-0190-00 | B030000 | | TRANSISTOR:NPN,SI,TO-92 | 80009 | 151-0190-00 |
| A15A1Q2132 | 151-0190-00 | B030000 | B031800 | TRANSISTOR:NPN,SI,TO-92 | 80009 | 151-0190-00 |
| A15A1Q2132 | 151-0432-00 | B031801 | | TRANSISTOR:NPN,SI,625MW,TO-92 | 04713 | SPS8512 |
| A15A1Q2138 | 151-0188-00 | | | TRANSISTOR:PMP,SI,TO-92 | 80009 | 151-0188-00 |
| A15A1Q2142 | 151-0190-00 | B030000 | | TRANSISTOR:NPN,SI,TO-92 | 80009 | 151-0190-00 |
| A15A1Q2151 | 151-0190-00 | B030000 | | TRANSISTOR:NPN,SI,TO-92 | 80009 | 151-0190-00 |
| A15A1Q2152 | 151-0190-00 | B030000 | | TRANSISTOR:NPN,SI,TO-92 | 80009 | 151-0190-00 |
| A15A1Q2153 | 151-0192-00 | B010100 | B029999 | TRANSISTOR:NPN,SI,TO-92 | 04713 | SPS8801 |
| A15A1Q2153 | 151-0190-00 | B030000 | | TRANSISTOR:NPN,SI,TO-92 | 80009 | 151-0190-00 |
| A15A1Q2159 | 151-0190-00 | B010100 | B029999 | TRANSISTOR:NPN,SI,TO-92 | 80009 | 151-0190-00 |
| A15A1Q2181 | 151-0190-00 | B030000 | | TRANSISTOR:NPN,SI,TO-92 | 80009 | 151-0190-00 |
| A15A1Q2215 | 151-0232-00 | B010100 | B029999 | TRANSISTOR:NPN,SI,TO-78 | 07263 | SP12141 |
| A15A1Q2223 | 151-0190-00 | B010100 | B029999 | TRANSISTOR:NPN,SI,TO-92 | 80009 | 151-0190-00 |
| A15A1Q2223 | 151-0190-00 | B030000 | | TRANSISTOR:NPN,SI,TO-92 | 80009 | 151-0190-00 |
| A15A1Q2225 | 151-0188-00 | B010100 | B029999 | TRANSISTOR:PMP,SI,TO-92 | 80009 | 151-0188-00 |

| Component No. | Tektronix Part No. | Serial/Assembly No. Effective | Discont | Name & Description | Mfr. Code | Mfr. Part No. |
|---------------|--------------------|-------------------------------|---------|--|-----------|---------------|
| A15A1Q2226 | 151-0190-00 | B030000 | | TRANSISTOR:NPN,SI,TO-92 | 80009 | 151-0190-00 |
| A15A1Q2227 | 151-0190-00 | B030000 | | TRANSISTOR:NPN,SI,TO-92 | 80009 | 151-0190-00 |
| A15A1Q2229 | 151-0190-00 | B010100 | B029999 | TRANSISTOR:NPN,SI,TO-92 | 80009 | 151-0190-00 |
| A15A1Q2229 | 151-0188-00 | B030000 | | TRANSISTOR:PNP,SI,TO-92 | 80009 | 151-0188-00 |
| A15A1Q2240 | 151-0190-00 | | | TRANSISTOR:NPN,SI,TO-92 | 80009 | 151-0190-00 |
| A15A1Q2243 | 151-0190-00 | B030000 | | TRANSISTOR:NPN,SI,TO-92 | 80009 | 151-0190-00 |
| A15A1Q2250 | 151-0188-00 | B030000 | | TRANSISTOR:PNP,SI,TO-92 | 80009 | 151-0188-00 |
| A15A1Q2255 | 151-1021-00 | B030000 | | TRANSISTOR:FET,N-CHAN,SI,TO-18 | 80009 | 151-1021-00 |
| A15A1Q22B6 | 151-0188-00 | B010100 | B029999 | TRANSISTOR:PNP,SI,TO-92 | 80009 | 151-0188-00 |
| A15A1Q22B7 | 151-0188-00 | B010100 | B029999 | TRANSISTOR:PNP,SI,TO-92 | 80009 | 151-0188-00 |
| A15A1Q2296 | 151-0188-00 | B010100 | B029999 | TRANSISTOR:PNP,SI,TO-92 | 80009 | 151-0188-00 |
| A15A1Q2296 | 151-1021-00 | B030000 | | TRANSISTOR:FET,N-CHAN,SI,TO-18 | 80009 | 151-1021-00 |
| A15A1Q2299 | 151-0188-00 | B010100 | B029999 | TRANSISTOR:PNP,SI,TO-92 | 80009 | 151-0188-00 |
| A15A1R2101 | 315-0682-00 | | | RES,FXD,FILM:6.8K OHM,5%,0.25W | 57668 | NTR25J-E06K8 |
| A15A1R2102 | 315-0103-00 | | | RES,FXD,FILM:10K OHM,5%,0.25W | 19701 | 5043CX10K00J |
| A15A1R2104 | 315-0333-00 | | | RES,FXD,FILM:33K OHM,5%,0.25W | 57668 | NTR25J-E33K0 |
| A15A1R2105 | 315-0153-00 | | | RES,FXD,FILM:15K OHM,5%,0.25W | 19701 | 5043CX15K00J |
| A15A1R2107 | 315-0510-00 | | | RES,FXD,FILM:51 OHM,5%,0.25W | 19701 | 5043CX51R00J |
| A15A1R2108 | 315-0512-00 | | | RES,FXD,FILM:5.1K OHM,5%,0.25W | 57668 | NTR25J-E05K1 |
| A15A1R2109 | 315-0221-00 | | | RES,FXD,FILM:220 OHM,5%,0.25W | 57668 | NTR25J-E220E |
| A15A1R2112 | 315-0102-00 | | | RES,FXD,FILM:1K OHM,5%,0.25W | 57668 | NTR25JE01K0 |
| A15A1R2113 | 315-0301-00 | | | RES,FXD,FILM:300 OHM,5%,0.25W | 57668 | NTR25J-E300E |
| A15A1R2122 | 315-0432-00 | | | RES,FXD,FILM:4.3K OHM,5%,0.25W | 57668 | NTR25J-E04K3 |
| A15A1R2123 | 315-0683-00 | | | RES,FXD,FILM:68K OHM,5%,0.25W | 57668 | NTR25J-E68K0 |
| A15A1R2125 | 315-0103-00 | B042482 | | RES,FXD,FILM:10K OHM,5%,0.25W | 19701 | 5043CX10K00J |
| A15A1R2127 | 315-0302-00 | B010100 | B029999 | RES,FXD,FILM:3K OHM,5%,0.25W | 57668 | NTR25J-ED3K0 |
| A15A1R2127 | 315-0102-00 | B030000 | | RES,FXD,FILM:1K OHM,5%,0.25W | 57668 | NTR25JE01K0 |
| A15A1R2128 | 311-1263-00 | B010100 | B029999 | RES,VAR,NONW:1K OHM,10%,0.50W | 32997 | 3329P-L58-102 |
| A15A1R2129 | 315-0183-00 | B010100 | B029999 | RES,FXD,FILM:18K OHM,5%,0.25W | 19701 | 5043CX18K00J |
| A15A1R2131 | 315-0472-00 | B030000 | | RES,FXD,FILM:4.7K OHM,5%,0.25W | 57668 | NTR25J-E04K7 |
| A15A1R2132 | 315-0222-00 | B030000 | | RES,FXD,FILM:2.2K OHM,5%,0.25W | 57668 | NTR25J-E02K2 |
| A15A1R2134 | 315-0302-00 | B030000 | | RES,FXD,FILM:3K OHM,5%,0.25W | 57668 | NTR25J-E03K0 |
| A15A1R2135 | 315-0393-00 | | | RES,FXD,FILM:39K OHM,5%,0.25W | 57668 | NTR25J-E39K0 |
| A15A1R2137 | 315-0752-00 | | | RES,FXD,FILM:7.5K OHM,5%,0.25W | 57668 | NTR25J-E07K5 |
| A15A1R2139 | 315-0242-00 | | | RES,FXD,FILM:2.4K OHM,5%,0.25W | 57668 | NTR25J-E02K4 |
| A15A1R2140 | 315-0103-00 | B030000 | | RES,FXD,FILM:10K OHM,5%,0.25W | 19701 | 5043CX10K00J |
| A15A1R2141 | 315-0102-00 | B030000 | | RES,FXD,FILM:1K OHM,5%,0.25W | 57668 | NTR25JE01K0 |
| A15A1R2144 | 315-0104-00 | | | RES,FXD,FILM:100K OHM,5%,0.25W | 57668 | NTR25J-E100K |
| A15A1R2146 | 315-0152-00 | | | RES,FXD,FILM:1.5K OHM,5%,0.25W | 57668 | NTR25J-E01K5 |
| A15A1R2148 | 315-0103-00 | B010100 | B029999 | RES,FXD,FILM:10K OHM,5%,0.25W | 19701 | 5043CX10K00J |
| A15A1R2150 | 321-0403-00 | B010100 | B029999 | RES,FXD,FILM:154K OHM,1%,0.125W,TC=TO | 07716 | CEAD15402F |
| A15A1R2150 | 315-0183-00 | B030000 | | RES,FXD,FILM:18K OHM,5%,0.25W | 19701 | 5043CX18K00J |
| A15A1R2151 | 321-0372-00 | B010100 | B029999 | RES,FXD,FILM:73.2K OHM,1%,0.125W,TC=TO | 07716 | CEAD73201F |
| A15A1R2151 | 315-0362-00 | B030000 | | RES,FXD,FILM:3.6K OHM,5%,0.25W | 19701 | 5043CX3K600J |
| A15A1R2152 | 315-0622-00 | B030000 | | RES,FXD,FILM:6.2K OHM,5%,0.25W | 19701 | 5043CX6K200J |
| A15A1R2153 | 315-0103-00 | B010100 | B029999 | RES,FXD,FILM:10K OHM,5%,0.25W | 19701 | 5043CX10K00J |
| A15A1R2153 | 315-0301-00 | B030000 | | RES,FXD,FILM:300 OHM,5%,0.25W | 57668 | NTR25J-E300E |
| A15A1R2154 | 321-0350-00 | B030000 | | RES,FXD,FILM:43.2K OHM,1%,0.125W,TC=TO | 19701 | 5043ED43K20F |
| A15A1R2155 | 315-0512-00 | B010100 | B029999 | RES,FXD,FILM:5.1K OHM,5%,0.25W | 57668 | NTR25J-E05K1 |
| A15A1R2155 | 321-0350-00 | B030000 | | RES,FXD,FILM:43.2K OHM,1%,0.125W,TC=TO | 19701 | 5043ED43K20F |
| A15A1R2157 | 315-0222-00 | B030000 | B041951 | RES,FXD,FILM:2.2K OHM,5%,0.25W | 57668 | NTR25J-E02K2 |
| A15A1R2157 | 315-0621-00 | B041952 | | RES,FXD,FILM:620 OHM,5%,0.25W | 57668 | NTR25J-E620E |
| A15A1R2158 | 315-0152-00 | B010100 | B029999 | RES,FXD,FILM:1.5K OHM,5%,0.25W | 57668 | NTR25J-E01K5 |
| A15A1R2159 | 315-0102-00 | B042482 | | RES,FXD,FILM:1K OHM,5%,0.25W | 57668 | NTR25JE01K0 |
| A15A1R2160 | 315-0102-00 | B042482 | | RES,FXD,FILM:1K OHM,5%,0.25W | 57668 | NTR25JE01K0 |
| A15A1R2161 | 315-0102-00 | | | RES,FXD,FILM:1K OHM,5%,0.25W | 57668 | NTR25JE01K0 |
| A15A1R2162 | 315-0751-00 | | | RES,FXD,FILM:750 OHM,5%,0.25W | 57668 | NTR25J-E750E |
| A15A1R2163 | 315-0751-00 | | | RES,FXD,FILM:750 OHM,5%,0.25W | 57668 | NTR25J-E750E |

Replaceable Electrical Parts - 7904A

| Component No. | Tektronix Part No. | Serial/Assembly No. Effective | Discont | Name & Description | Mfr. Code | Mfr. Part No. |
|---------------|--------------------|-------------------------------|---------|--|-----------|---------------|
| A15A1R2165 | 315-0102-00 | | | RES,FXD,FILM:1K OHM,5%,0.25W | 57668 | NTR25JE01K0 |
| A15A1R2166 | 315-0751-00 | | | RES,FXD,FILM:750 OHM,5%,0.25W | 57668 | NTR25J-E750E |
| A15A1R2167 | 315-0751-00 | | | RES,FXD,FILM:750 OHM,5%,0.25W | 57668 | NTR25J-E750E |
| A15A1R2169 | 315-0102-00 | | | RES,FXD,FILM:1K OHM,5%,0.25W | 57668 | NTR25JE01K0 |
| A15A1R2170 | 315-0751-00 | | | RES,FXD,FILM:750 OHM,5%,0.25W | 57668 | NTR25J-E750E |
| A15A1R2171 | 315-0751-00 | | | RES,FXD,FILM:750 OHM,5%,0.25W | 57668 | NTR25J-E750E |
| A15A1R2173 | 315-0102-00 | | | RES,FXD,FILM:1K OHM,5%,0.25W | 57668 | NTR25JE01K0 |
| A15A1R2174 | 315-0751-00 | | | RES,FXD,FILM:750 OHM,5%,0.25W | 57668 | NTR25J-E750E |
| A15A1R2175 | 315-0751-00 | | | RES,FXD,FILM:750 OHM,5%,0.25W | 57668 | NTR25J-E750E |
| A15A1R2177 | 315-0511-00 | B010100 | B029999 | RES,FXD,FILM:510 OHM,5%,0.25W | 19701 | 5043CX510R0J |
| A15A1R2178 | 315-0511-00 | B010100 | B029999 | RES,FXD,FILM:510 OHM,5%,0.25W | 19701 | 5043CX510R0J |
| A15A1R2179 | 315-0511-00 | B010100 | B029999 | RES,FXD,FILM:510 OHM,5%,0.25W | 19701 | 5043CX510RDJ |
| A15A1R2180 | 313-1103-00 | B042194 | | RES,FXD,FILM:10K OHM,5%,0.2W | 57668 | TR20JE10K0 |
| A15A1R2181 | 321-0386-00 | B030000 | | RES,FXD,FILM:102K OHM,1%,0.125W,TC=TO | 07716 | CEAD10202F |
| A15A1R2182 | 321-0262-00 | B010100 | B029999 | RES,FXD,FILM:5.23K OHM,1,0.125W,TC=TO | 19701 | 5033ED5K230F |
| A15A1R2182 | 321-0361-00 | B030000 | B042193 | RES,FXD,FILM:56.2K OHM,1%,0.125W,TC=TO | 07716 | CEAD56201F |
| A15A1R2182 | 321-0756-00 | B042194 | | RES,FXD,FILM:50K OHM,1%,0.125W,TC=TO | 24546 | NA55D5002F |
| A15A1R2183 | 311-1224-00 | B010100 | B029999 | RES,VAR,NONNW:TRMR,500 OHM,0.5W | 32997 | 3386F-T04-501 |
| A15A1R2183 | 311-2230-00 | B030000 | | RES,VAR,NONNW:TRMR,500 OHM,20%,0.5D LINEAR | TK1450 | GF06UT 500 |
| A15A1R2184 | 321-0262-00 | B030000 | | RES,FXD,FILM:5.23K OHM,1,0.125W,TC=TO | 19701 | 5033ED5K230F |
| A15A1R2185 | 307-0445-00 | B030000 | | RES NTWK,FXD,FI:4.7K OHM,20%,(9)RES | 32997 | 4310R-101-472 |
| A15A1R2187 | 315-0102-00 | B030000 | | RES,FXD,FILM:1K OHM,5%,0.25W | 57668 | NTR25JE01K0 |
| A15A1R2191 | 315-0513-00 | B010100 | B029999 | RES,FXD,FILM:51K OHM,5%,0.25W | 57668 | NTR25J-E51K0 |
| A15A1R2191 | 321-0356-00 | B030000 | | RES,FXD,FILM:49.9K OHM,1%,0.125W,TC=TO | 19701 | 5033ED49K90F |
| A15A1R2192 | 315-0133-00 | B010100 | B029999 | RES,FXD,FILM:13K OHM,5%,0.25W | 19701 | 5043CX13K00J |
| A15A1R2192 | 321-0344-00 | B030000 | | RES,FXD,FILM:37.4K OHM,1%,0.125W,TC=TO | 19701 | 5033ED 37K40F |
| A15A1R2193 | 315-0133-00 | B010100 | B029999 | RES,FXD,FILM:13K OHM,5%,0.25W | 19701 | 5043CX13K00J |
| A15A1R2193 | 321-0306-00 | B030000 | | RES,FXD,FILM:15.0K OHM,1%,0.125W,TC=TO | 19701 | 5033ED15JD0F |
| A15A1R2194 | 315-0753-00 | B010100 | B029999 | RES,FXD,FILM:75K OHM,5%,0.25W | 57668 | NTR25J-E75K0 |
| A15A1R2194 | 321-0373-00 | B030000 | | RES,FXD,FILM:75.0K OHM,1%,0.125W,TC=TO | 19701 | 5033ED75K00F |
| A15A1R2196 | 321-0308-00 | B010100 | B029999 | RES,FXD,FILM:15.8K OHM,1%,0.125W,TC=TO | 07716 | CEAD 15801F |
| A15A1R2196 | 321-0311-00 | B030000 | | RES,FXD,FILM:16.9K OHM,1%,0.125W,TC=TO | 07716 | CEAC16901F |
| A15A1R2197 | 315-0513-00 | B010100 | B029999 | RES,FXD,FILM:51K OHM,5%,0.25W | 57668 | NTR25J-E51K0 |
| A15A1R2197 | 321-0356-00 | B030000 | | RES,FXD,FILM:49.9K OHM,1%,0.125W,TC=TO | 19701 | 5033ED49K90F |
| A15A1R2198 | 321-0319-00 | B010100 | B029999 | RES,FXD,FILM:20.5K OHM,1%,0.125W,TC=TO | 19701 | 5033ED20K50F |
| A15A1R2198 | 321-0321-00 | B030000 | | RES,FXD,FILM:21.5K OHM,1%,0.125W,TC=TO | 07716 | CEAD21501F |
| A15A1R2199 | 321-0335-00 | | | RES,FXD,FILM:30.1K OHM,1%,0.125W,TC=TO | 57668 | RB14FXE30K1 |
| A15A1R2201 | 315-0154-00 | B010100 | B029999 | RES,FXD,FILM:150K OHM,5%,0.25W | 57668 | NTR25J-E150K |
| A15A1R2201 | 315-0471-00 | B030000 | | RES,FXD,FILM:470 OHM,5%,0.25W | 57668 | NTR25J-E470E |
| A15A1R2202 | 321-0335-00 | B010100 | B029999 | RES,FXD,FILM:30.1K OHM,1%,0.125W,TC=TO | 57668 | RB14FXE30K1 |
| A15A1R2202 | 315-0182-00 | B030000 | | RES,FXD,FILM:1.8K OHM,5%,0.25W | 57668 | NTR25J-E1K8 |
| A15A1R2203 | 321-0344-00 | B010100 | B029999 | RES,FXD,FILM:37.4K OHM,1%,0.125W,TC=TO | 19701 | 5033ED 37K40F |
| A15A1R2203 | 315-0511-00 | B030000 | | RES,FXD,FILM:510 OHM,5%,0.25W | 19701 | 5043CX510RDJ |
| A15A1R2204 | 321-0335-00 | B010100 | B029999 | RES,FXD,FILM:30.1K OHM,1%,0.125W,TC=TO | 57668 | RB14FXE30K1 |
| A15A1R2204 | 307-0446-00 | B030000 | | RES NTWK,FXD,FI:10K OHM,20%,(9)RES | 11236 | 750-101-R10K |
| A15A1R2206 | 315-0513-00 | B010100 | B029999 | RES,FXD,FILM:51K OHM,5%,0.25W | 57668 | NTR25J-E51K0 |
| A15A1R2206 | 321-0376-00 | B030000 | | RES,FXD,FILM:80.6K OHM,1%,0.125W,TC=TO | 19701 | 5043ED80K60F |
| A15A1R2207 | 315-0154-00 | B010100 | B029999 | RES,FXD,FILM:150K OHM,5%,0.25W | 57668 | NTR25J-E150K |
| A15A1R2207 | 321-0405-00 | B030000 | | RES,FXD,FILM:162K OHM,1%,0.125W,TC=TO | 07716 | CEAD16202F |
| A15A1R2208 | 321-0335-00 | B010100 | B029999 | RES,FXD,FILM:30.1K OHM,1%,0.125W,TC=TO | 57668 | RB14FXE30K1 |
| A15A1R2208 | 321-0434-00 | B030000 | | RES,FXD,FILM:324K OHM,1%,0.125W,TC=TO | 07716 | CEAD32402F |
| A15A1R2209 | 321-0335-00 | B010100 | B029999 | RES,FXD,FILM:30.1K OHM,1%,0.125W,TC=TO | 57668 | RB14FXE30K1 |
| A15A1R2210 | 311-2232-00 | B030000 | | RES,VAR,NONNW:TRMR,2K OHM,20%,0.5W LINEAR | TK1450 | GF06UT 2K |
| A15A1R2211 | 315-0752-00 | B010100 | B029999 | RES,FXD,FILM:7.5K OHM,5%,0.25W | 57668 | NTR25J-E07K5 |
| A15A1R2211 | 315-0332-00 | B030000 | | RES,FXD,FILM:3.3K OHM,5%,0.25W | 57668 | NTR25J-E03K3 |
| A15A1R2212 | 321-0218-00 | B030000 | | RES,FXD,FILM:1.82K OHM,1%,0.125W,TC=TO | 19701 | 5033ED1K82F |
| A15A1R2213 | 321-0259-00 | B010100 | B029999 | RES,FXD,FILM:4.87K OHM,1%,0.125W,TC=TO | 07716 | CEAD48700F |
| A15A1R2213 | 321-0221-00 | B030000 | | RES,FXD,FILM:1.96K OHM,1%,0.125W,TC=TO | 19701 | 5043ED1K960F |

| Component No. | Tektronix Part No. | Serial/Assembly No. Effective | Discont | Name & Description | Mfr. Code | Mfr. Part No. |
|---------------|--------------------|-------------------------------|---------|--|-----------|---------------|
| A15A1R2214 | 311-1224-00 | B010100 | B029999 | RES, VAR, NONNW: TRMR, 500 OHM, 0.5W | 32997 | 3386F-T04-501 |
| A15A1R2215 | 315-0133-00 | B010100 | B029999 | RES, FXD, FILM: 13K OHM, 5%, 0.25W | 19701 | 5043CX13K00J |
| A15A1R2216 | 321-0452-00 | B030000 | | RES, FXD, FILM: 499K OHM, 1%, 0.125W, TC=TO | 19701 | 5043ED499K0F |
| A15A1R2217 | 315-0124-00 | B010100 | B029999 | RES, FXD, FILM: 120K OHM, 5%, 0.25W | 19701 | 5043CX120K0J |
| A15A1R2217 | 321-0425-00 | B030000 | | RES, FXD, FILM: 261K OHM, 1%, 0.125W, TC=TO | 07716 | CEAD26102F |
| A15A1R2218 | 321-0396-00 | B030000 | | RES, FXD, FILM: 130K OHM, 1%, 0.125W, TC=TO | 07716 | CEAD13002F |
| A15A1R2219 | 315-0751-00 | B010100 | B029999 | RES, FXD, FILM: 750 OHM, 5%, 0.25W | 57668 | NTR25J-E750E |
| A15A1R2220 | 321-0299-00 | B010100 | B029999 | RES, FXD, FILM: 12.7K OHM, 1%, 0.125W, TC=TO | 19701 | 5033ED12K70F |
| A15A1R2221 | 321-0212-00 | B010100 | B029999 | RES, FXD, FILM: 1.58K OHM, 1%, 0.125W, TC=TO | 19701 | 5033ED1K58F |
| A15A1R2221 | 315-0752-00 | B030000 | | RES, FXD, FILM: 7.5K OHM, 5%, 0.25W | 57668 | NTR25J-E07K5 |
| A15A1R2222 | 315-0133-00 | B030000 | | RES, FXD, FILM: 13K OHM, 5%, 0.25W | 19701 | 5043CX13K00J |
| A15A1R2223 | 315-0124-00 | B030000 | | RES, FXD, FILM: 120K OHM, 5%, 0.25W | 19701 | 5043CX120K0J |
| A15A1R2224 | 315-0751-00 | B030000 | | RES, FXD, FILM: 750 OHM, 5%, 0.25W | 57668 | NTR25J-E750E |
| A15A1R2225 | 321-0299-00 | B030000 | | RES, FXD, FILM: 12.7K OHM, 1%, 0.125W, TC=TO | 19701 | 5033ED12K70F |
| A15A1R2226 | 315-0222-00 | B010100 | B029999 | RES, FXD, FILM: 2.2K OHM, 5%, 0.25W | 57668 | NTR25J-E02K2 |
| A15A1R2226 | 321-0212-00 | B030000 | | RES, FXD, FILM: 1.58K OHM, 1%, 0.125W, TC=TO | 19701 | 5033ED1K58F |
| A15A1R2227 | 321-0268-00 | B010100 | B029999 | RES, FXD, FILM: 6.04K OHM, 1%, 0.125W, TC=TO | 19701 | 5043ED6K040F |
| A15A1R2227 | 315-0152-00 | B030000 | | RES, FXD, FILM: 1.5K OHM, 5%, 0.25W | 57668 | NTR25J-E01K5 |
| A15A1R2229 | 321-0210-00 | B010100 | B029999 | RES, FXD, FILM: 1.50K OHM, 1%, 0.125W, TC=TO | 19701 | 5033ED1K50F |
| A15A1R2229 | 315-0512-00 | B030000 | | RES, FXD, FILM: 5.1K OHM, 5%, 0.25W | 57668 | NTR25J-E05K1 |
| A15A1R2230 | 315-0103-00 | B030000 | | RES, FXD, FILM: 10K OHM, 5%, 0.25W | 19701 | 5043CX10K00J |
| A15A1R2231 | 315-0303-00 | B010100 | B029999 | RES, FXD, FILM: 30K OHM, 5%, 0.25W | 19701 | 5043CX30K00J |
| A15A1R2235 | 315-0203-00 | | | RES, FXD, FILM: 20K OHM, 5%, 0.25W | 57668 | NTR25J-E 20K |
| A15A1R2236 | 315-0203-00 | | | RES, FXD, FILM: 20K OHM, 5%, 0.25W | 57668 | NTR25J-E 20K |
| A15A1R2237 | 315-0203-00 | | | RES, FXD, FILM: 20K OHM, 5%, 0.25W | 57668 | NTR25J-E 20K |
| A15A1R2238 | 315-0203-00 | | | RES, FXD, FILM: 20K OHM, 5%, 0.25W | 57668 | NTR25J-E 20K |
| A15A1R2239 | 315-0303-00 | B030000 | B031859 | RES, FXD, FILM: 30K OHM, 5%, 0.25W | 19701 | 5043CX30K00J |
| A15A1R2239 | 315-0104-00 | B031860 | | RES, FXD, FILM: 100K OHM, 5%, 0.25W | 57668 | NTR25J-E100K |
| A15A1R2241 | 321-0326-00 | B010100 | B029999 | RES, FXD, FILM: 24.3K OHM, 1%, 0.125W, TC=TO | 19701 | 5043ED24K30F |
| A15A1R2242 | 321-0259-00 | B030000 | | RES, FXD, FILM: 4.87K OHM, 1%, 0.125W, TC=TO | 07716 | CEAD48700F |
| A15A1R2243 | 311-2230-00 | B030000 | | RES, VAR, NONNW: TRMR, 500 OHM, 20%, 0.50 LINEAR | TK1450 | GF06UT 500 |
| A15A1R2244 | 321-0326-00 | B030000 | | RES, FXD, FILM: 24.3K OHM, 1%, 0.125W, TC=TO | 19701 | 5043ED24K30F |
| A15A1R2245 | 315-0472-00 | B030000 | | RES, FXD, FILM: 4.7K OHM, 5%, 0.25W | 57668 | NTR25J-E04K7 |
| A15A1R2246 | 307-0445-00 | B030000 | | RES, NTWK, FXD, FI: 4.7K OHM, 20%, (9) RES | 32997 | 4310R-101-472 |
| A15A1R2247 | 315-0472-00 | B030000 | | RES, FXD, FILM: 4.7K OHM, 5%, 0.25W | 57668 | NTR25J-E04K7 |
| A15A1R2250 | 315-0222-00 | B030000 | B041951 | RES, FXD, FILM: 2.2K OHM, 5%, 0.25W | 57668 | NTR25J-E02K2 |
| A15A1R2250 | 315-0621-00 | B041952 | | RES, FXD, FILM: 620 OHM, 5%, 0.25W | 57668 | NTR25J-E620E |
| A15A1R2251 | 315-0102-00 | B010100 | B029999 | RES, FXD, FILM: 1K OHM, 5%, 0.25W | 57668 | NTR25JE01K0 |
| A15A1R2251 | 315-0203-00 | B030000 | B041951 | RES, FXD, FILM: 20K OHM, 5%, 0.25W | 57668 | NTR25J-E 20K |
| A15A1R2251 | 315-0472-00 | B041952 | | RES, FXD, FILM: 4.7K OHM, 5%, 0.25W | 57668 | NTR25J-E04K7 |
| A15A1R2252 | 315-0102-00 | B010100 | B029999 | RES, FXD, FILM: 1K OHM, 5%, 0.25W | 57668 | NTR25JE01K0 |
| A15A1R2252 | 321-0202-00 | B030000 | | RES, FXD, FILM: 1.24K OHM, 1%, 0.125W, TC=TO | 24546 | NA55D1241F |
| A15A1R2253 | 315-0102-00 | B010100 | B029999 | RES, FXD, FILM: 1K OHM, 5%, 0.25W | 57668 | NTR25JE01K0 |
| A15A1R2253 | 321-0202-00 | B030000 | | RES, FXD, FILM: 1.24K OHM, 1%, 0.125W, TC=TO | 24546 | NA55D1241F |
| A15A1R2254 | 315-0303-00 | B010100 | B029999 | RES, FXD, FILM: 30K OHM, 5%, 0.25W | 19701 | 5043CX30K00J |
| A15A1R2254 | 321-0254-00 | B030000 | | RES, FXD, FILM: 4.32K OHM, 1%, 0.125W, TC=TO | 07716 | CEAD43200F |
| A15A1R2255 | 321-0302-00 | B030000 | | RES, FXD, FILM: 13.7K OHM, 1%, 0.125W, TC=TD | 07716 | CEAD 13701F |
| A15A1R2257 | 321-0251-00 | B030000 | | RES, FXD, FILM: 4.02K OHM, 1%, 0.125W, TC=TO | 19701 | 5033ED4K020F |
| A15A1R2258 | 315-0203-00 | B030000 | | RES, FXD, FILM: 20K OHM, 5%, 0.25W | 57668 | NTR25J-E 20K |
| A15A1R2259 | 313-0303-00 | B030000 | | RES, FXD, FILM: 30K OHM, 5%, 0.166W | 80009 | 313-0303-00 |
| A15A1R2260 | 311-2232-00 | B030000 | | RES, VAR, NONNW: TRMR, 2K OHM, 20%, 0.5W LINEAR | TK1450 | GF06UT 2K |
| A15A1R2261 | 315-0272-00 | B010100 | B029999 | RES, FXD, FILM: 2.7K OHM, 5%, 0.25W | 57668 | NTR25J-E02K7 |
| A15A1R2262 | 315-0102-00 | B010100 | B029999 | RES, FXD, FILM: 1K OHM, 5%, 0.25W | 57668 | NTR25JE01K0 |
| A15A1R2263 | 307-0696-00 | B030000 | | RES, NTWK, FXD, FI: 7.10K OHM, 2%, 0.15W EACH | 01121 | 108A103 |
| A15A1R2264 | 321-0318-00 | B030000 | | RES, FXD, FILM: 20.0K OHM, 1%, 0.125W, TC=TO | 19701 | 5033ED20K00F |
| A15A1R2265 | 315-0512-00 | B010100 | B029999 | RES, FXD, FILM: 5.1K OHM, 5%, 0.25W | 57668 | NTR25J-E05K1 |
| A15A1R2265 | 321-0259-00 | B030000 | | RES, FXD, FILM: 4.87K OHM, 1%, 0.125W, TC=TO | 07716 | CEAD48700F |
| A15A1R2266 | 315-0912-00 | B010100 | B029999 | RES, FXD, FILM: 9.1K OHM, 5%, 0.25W | 57668 | NTR25J-E09K1 |

Replaceable Electrical Parts - 7904A

| Component No. | Tektronix Part No. | Serial/Assembly No. Effective | Discnt | Name & Description | Mfr. Code | Mfr. Part No. |
|---------------|--------------------|-------------------------------|---------|---|-----------|------------------|
| A15A1R2266 | 321-0430-00 | B030000 | | RES,FXD,FILM:294K OHM,1%,0.125W,TC=TO | 07716 | CEAD29402F |
| A15A1R2267 | 321-0399-00 | B030000 | | RES,FXD,FILM:140K OHM,1%,0.125W,TC=TO | 07716 | CEAD14002F |
| A15A1R2268 | 321-0297-00 | B010100 | B029999 | RES,FXD,FILM:12.1K OHM,1%,0.125W,TC=TO | 07716 | CEAD12101F |
| A15A1R2268 | 321-0294-00 | B021190 | B029999 | RES,FXD,FILM:11.3K OHM,1%,0.125W,TC=TO | 19701 | 5043ED11K30F |
| A15A1R2268 | 321-0295-00 | B021190 | B029999 | RES,FXD,FILM:11.5K OHM,1%,0.125W,TC=TO | 07716 | CEAD11501F |
| A15A1R2268 | 321-0296-00 | B021190 | B029999 | RES,FXD,FILM:11.8K OHM,1%,0.125W,TC=TO | 07716 | CEAD11801F |
| A15A1R2268 | 321-0298-00 | B021190 | B029999 | RES,FXD,FILM:12.4K OHM,1%,0.125W,TC=TO | 07716 | CEAD12401F |
| A15A1R2268 | 321-0299-00 | B021190 | B029999 | RES,FXD,FILM:12.7K OHM,1%,0.125W,TC=TO | 19701 | 5033ED12K70F |
| A15A1R2268 | 321-0631-00 | B021190 | B029999 | RES,FXD,FILM:12.5K OHM,1%,0.125W,TC=TO | 91637 | MFF1816G12501F |
| A15A1R2268 | 321-0367-00 | B030000 | | RES,FXD,FILM:64.9K OHM,1%,0.125W,TC=TO (R2268 IS SELECTABLE) | 07716 | CEAD64901F |
| A15A1R2269 | 321-0331-00 | B030000 | | RES,FXD,FILM:27.4K OHM,1%,0.125W,TC=TO | 19701 | 5043ED27K40F |
| A15A1R2271 | 315-0183-00 | B030000 | | RES,FXD,FILM:18K OHM,5%,0.25W | 19701 | 5043CX18K00J |
| A15A1R2273 | 311-1226-00 | B010100 | B029999 | RES,VAR,NONWw:TRMR,2.5K OHM,0.5W | 32997 | 3386F-T04-252 |
| A15A1R2274 | 321-0153-00 | B010100 | B029999 | RES,FXD,FILM:383 OHM,1%,0.125W,TC=TO | 07716 | CEAD383ROF |
| A15A1R2275 | 321-0170-00 | B010100 | B029999 | RES,FXD,FILM:576 OHM,1%,0.125W,TC=TO | 07716 | CEAD576ROF |
| A15A1R2276 | 315-0223-00 | B010100 | B029999 | RES,FXD,FILM:22K OHM,5%,0.25W | 19701 | 5043CX22K00J92U |
| A15A1R2276 | 321-0251-00 | B030000 | | RES,FXD,FILM:4.02K OHM,1%,0.125W,TC=TO | 19701 | 5033ED4K020F |
| A15A1R2277 | 321-0250-00 | B010100 | B029999 | RES,FXD,FILM:3.92K OHM,1%,0.125W,TC=TO | 07716 | CEAD39200F |
| A15A1R2277 | 321-0218-00 | B030000 | | RES,FXD,FILM:1.82K OHM,1%,0.125W,TC=TO | 19701 | 5033ED1K82F |
| A15A1R2278 | 315-0823-00 | B010100 | B029999 | RES,FXD,FILM:82K OHM,5%,0.25W | 57668 | NTR25J-E82K |
| A15A1R2279 | 321-0222-00 | B010100 | B029999 | RES,FXD,FILM:2.00K OHM,1%,0.125W,TC=TO | 19701 | 5033ED2K00F |
| A15A1R2279 | 321-0221-00 | B030000 | | RES,FXD,FILM:1.96K OHM,1%,0.125W,TC=TO | 19701 | 5043ED1K960F |
| A15A1R2280 | 315-0823-00 | B010100 | B029999 | RES,FXD,FILM:82K OHM,5%,0.25W | 57668 | NTR25J-E82K |
| A15A1R2280 | 321-0254-00 | B030000 | | RES,FXD,FILM:4.32K OHM,1%,0.125W,TC=TO | 07716 | CEAD43200F |
| A15A1R2281 | 315-0101-00 | B010100 | B029999 | RES,FXD,FILM:100 OHM,5%,0.25W | 57668 | NTR25J-E 100E |
| A15A1R2282 | 315-0332-00 | B010100 | B029999 | RES,FXD,FILM:3.3K OHM,5%,0.25W | 57668 | NTR25J-E03K3 |
| A15A1R2283 | 315-0753-00 | B010100 | B029999 | RES,FXD,FILM:75K OHM,5%,0.25W | 57668 | NTR25J-E75K0 |
| A15A1R2284 | 321-0216-00 | B010100 | B029999 | RES,FXD,FILM:1.74K OHM,1%,0.125W,TC=TO | 07716 | CEAD17400F |
| A15A1R2285 | 321-0245-00 | B010100 | B029999 | RES,FXD,FILM:3.48K OHM,1%,0.125W,TC=TO | 19701 | 5033ED3K48F |
| A15A1R2285 | 321-0242-00 | B021190 | B029999 | RES,FXD,FILM:3.24K OHM,1%,0.125W,TC=TO | 19701 | 5043ED3K240F |
| A15A1R2285 | 321-0243-00 | B021190 | B029999 | RES,FXD,FILM:3.32K OHM,1%,0.125W,TC=TO | 19701 | 5033ED3K32F |
| A15A1R2285 | 321-0244-00 | B021190 | B029999 | RES,FXD,FILM:3.40K OHM,1%,0.125W,TC=TO | 19701 | 5043ED3K400F |
| A15A1R2285 | 321-0246-00 | B021190 | B029999 | RES,FXD,FILM:3.57K OHM,1%,0.125W,TC=TO | 19701 | 5043ED3K570F |
| A15A1R2285 | 321-0247-00 | B021190 | B029999 | RES,FXD,FILM:3.65K OHM,1%,0.125W,TC=TO | 19701 | 5043ED3K650F |
| A15A1R2285 | 321-0248-00 | B021190 | B029999 | RES,FXD,FILM:3.74K OHM,1%,0.125W,TC=TO (R2285 IS SELECTABLE) | 19701 | 5043ED3K740F |
| A15A1R2286 | 321-0210-00 | B010100 | B029999 | RES,FXD,FILM:1.50K OHM,1%,0.125W,TC=TO | 19701 | 5033ED1K50F |
| A15A1R2286 | 307-0651-00 | B030000 | | RES NTWK,FXD,FI:5,3.3K OHM,5%,0.150W | 11236 | 750-61-R3.3K OHM |
| A15A1R2287 | 321-0199-00 | B010100 | B029999 | RES,FXD,FILM:1.15K OHM,1%,0.125W,TC=TO | 07716 | CEAD11500F |
| A15A1R2288 | 321-0273-00 | B010100 | B029999 | RES,FXD,FILM:6.81K OHM,1%,0.125W,TC=TO | 07716 | CEAD68100F |
| A15A1R2288 | 321-0353-00 | B030000 | | RES,FXD,FILM:46.4K OHM,1%,0.125W,TC=TO | 07716 | CEAD46401F |
| A15A1R2289 | 321-0193-00 | B010100 | B029999 | RES,FXD,FILM:1K OHM,1%,0.125W,TC=TO | 19701 | 5033ED1K00F |
| A15A1R2289 | 321-0335-00 | B030000 | | RES,FXD,FILM:30.1K OHM,1%,0.125W,TC=TO | 57668 | RB14FXE30K1 |
| A15A1R2290 | 321-0321-00 | B030000 | | RES,FXD,FILM:21.5K OHM,1%,0.125W,TC=TO | 07716 | CEAD21501F |
| A15A1R2291 | 311-1225-00 | B010100 | B029999 | RES,VAR,NONWw:TRMR,1K OHM,0.5W | 32997 | 3386F-T04-102 |
| A15A1R2291 | 321-0310-00 | B030000 | | RES,FXD,FILM:16.5K OHM,1%,0.125W,TC=TO | 19701 | 5033ED16K50F |
| A15A1R2292 | 315-0132-00 | B010100 | B029999 | RES,FXD,FILM:1.3K OHM,5%,0.25W | 57668 | NTR25J-E01K3 |
| A15A1R2292 | 321-0301-00 | B030000 | | RES,FXD,FILM:13.3K OHM,1%,0.125W,TC=TO | 07716 | CEAD13301F |
| A15A1R2293 | 321-0245-00 | B010100 | B029999 | RES,FXD,FILM:3.48K OHM,1%,0.125W,TC=TO | 19701 | 5033ED3K48F |
| A15A1R2293 | 321-0302-00 | B030000 | | RES,FXD,FILM:13.7K OHM,1%,0.125W,TC=TO | 07716 | CEAD 13701F |
| A15A1R2294 | 321-0255-00 | B010100 | B029999 | RES,FXD,FILM:4.42K OHM,1%,0.125W,TC=TO | 19701 | 5033ED4K420F |
| A15A1R2295 | 321-0241-00 | B010100 | B029999 | RES,FXD,FILM:3.16K OHM,1%,0.125W,TC=TO | 07716 | CEAD31600F |
| A15A1R2296 | 321-0251-00 | B030000 | | RES,FXD,FILM:4.02K OHM,1%,0.125W,TC=TO | 19701 | 5033ED4K020F |
| A15A1R2297 | 315-0152-00 | B010100 | B029999 | RES,FXD,FILM:1.5K OHM,5%,0.25W | 57668 | NTR25J-E01K5 |
| A15A1R2297 | 321-0254-00 | B030000 | | RES,FXD,FILM:4.32K OHM,1%,0.125W,TC=TO | 07716 | CEAD43200F |
| A15A1R2298 | 315-0102-00 | B010100 | B029999 | RES,FXD,FILM:1K OHM,5%,0.25W | 57668 | NTR25JE01K0 |
| A15A1R2298 | 315-0203-00 | B030000 | | RES,FXD,FILM:20K OHM,5%,0.25W | 57668 | NTR25J-E 20K |
| A15A1R2299 | 315-0431-00 | B010100 | B029999 | RES,FXD,FILM:430 OHM,5%,0.25W | 19701 | 5043CX430R0J |
| A15A1R3486 | 315-0241-00 | B031801 | | RES,FXD,FILM:240 OHM,5%,0.25W | 19701 | 5043CX240R0J |

| Component No. | Tektronix Part No. | Serial/Assembly No. Effective | Discnt | Name & Description | Mfr. Code | Mfr. Part No. |
|---------------|--------------------|-------------------------------|---------|--|-----------|-----------------|
| A15A1S2110 | 260-0723-00 | B010100 | B029999 | SWITCH,SLIDE:DPDT,0.5A,125VAC | 79727 | GF126-0028 |
| A15A1TP2112 | 214-0579-00 | B010100 | B029999 | TERM,TEST POINT:BRS CD PL | 80009 | 214-0579-00 |
| A15A1TP2113 | 214-0579-00 | B010100 | B029999 | TERM,TEST POINT:BRS CD PL | 80009 | 214-0579-00 |
| A15A1TP2115 | 214-0579-00 | B010100 | B029999 | TERM,TEST POINT:BRS CD PL | 80009 | 214-0579-00 |
| A15A1TP2117 | 214-0579-00 | B010100 | B029999 | TERM,TEST POINT:BRS CD PL | 80009 | 214-0579-00 |
| A15A1TP2119 | 214-0579-00 | B010100 | B029999 | TERM,TEST POINT:BRS CD PL | 80009 | 214-0579-00 |
| A15A1TP2129 | 214-0579-00 | B010100 | B029999 | TERM,TEST POINT:BRS CD PL | 80009 | 214-0579-00 |
| A15A1TP2131 | 214-0579-00 | B010100 | B029999 | TERM,TEST POINT:BRS CD PL | 80009 | 214-0579-00 |
| A15A1TP2133 | 214-0579-00 | B010100 | B029999 | TERM,TEST POINT:BRS CD PL | 80009 | 214-0579-00 |
| A15A1TP2135 | 214-0579-00 | B010100 | B029999 | TERM,TEST POINT:BRS CD PL | 80009 | 214-0579-00 |
| A15A1TP2154 | 214-0579-00 | B010100 | B029999 | TERM,TEST POINT:BRS CD PL | 80009 | 214-0579-00 |
| A15A1TP2159 | 214-0579-00 | B010100 | B029999 | TERM,TEST POINT:BRS CD PL | 80009 | 214-0579-00 |
| A15A1TP2180 | 214-0579-00 | | | TERM,TEST POINT:BRS CD PL | 80009 | 214-0579-00 |
| A15A1TP2199 | 214-0579-00 | B010100 | B029999 | TERM,TEST POINT:BRS CD PL | 80009 | 214-0579-00 |
| A15A1TP2209 | 214-0579-00 | B010100 | B029999 | TERM,TEST POINT:BRS CD PL | 80009 | 214-0579-00 |
| A15A1TP2211 | 214-0579-00 | B010100 | B029999 | TERM,TEST POINT:BRS CD PL | 80009 | 214-0579-00 |
| A15A1TP2226 | 214-0579-00 | B010100 | B029999 | TERM,TEST POINT:BRS CD PL | 80009 | 214-0579-00 |
| A15A1TP2232 | 214-0579-00 | B010100 | B029999 | TERM,TEST POINT:BRS CD PL | 80009 | 214-0579-00 |
| A15A1TP2250 | 214-0579-00 | B010100 | B029999 | TERM,TEST POINT:BRS CD PL | 80009 | 214-0579-00 |
| A15A1TP2251 | 214-0579-00 | B010100 | B029999 | TERM,TEST POINT:BRS CD PL | 80009 | 214-0579-00 |
| A15A1TP2296 | 214-0579-00 | B010100 | B029999 | TERM,TEST POINT:BRS CD PL | 80009 | 214-0579-00 |
| A15A1TP2299 | 214-0579-00 | B010100 | B029999 | TERM,TEST POINT:BRS CD PL | 80009 | 214-0579-00 |
| A15A1U2120 | 156-0043-03 | | | MICROCKT,DGTL:TTL,QUAD 2 INP NOR GATE,SCRN | 18324 | N7402(NB OR FB) |
| A15A1U2126 | 155-0021-01 | | | MICROCKT,DGTL:SCAN OSCILLATOR & LOGIC | 80009 | 155-0021-01 |
| A15A1U2127 | 156-1172-01 | B030000 | B042099 | MICROCKT,DGTL:DUAL 4 BIT BIN CNTR,SCRN | 80009 | 156-1172-01 |
| A15A1U2127 | 156-1172-02 | B042100 | | MICROCKT,DGTL:DUAL 4-STAGE BIN CNTR,SCRN | 80009 | 156-1172-02 |
| A15A1U2155 | 156-0043-03 | | | MICROCKT,DGTL:TTL,QUAD 2 INP NOR GATE,SCRN | 18324 | N7402(NB OR FB) |
| A15A1U2157 | 156-0730-02 | B030000 | | MICROCKT,DGTL:QUAD 2-INP NOR BFR,SCRN | 80009 | 156-0730-02 |
| A15A1U2159 | 155-0017-00 | | | MICROCKT,DGTL:BCD DECIMAL | 80009 | 155-0017-00 |
| A15A1U2162 | 156-0388-03 | B030000 | | MICROCKT,DGTL:DUAL D FLIP-FLOP,SCRN | 01295 | SN74LS74ANP3 |
| A15A1U2180 | 155-0015-01 | | | MICROCKT,DGTL:ANALOG DATA SWITCH | 80009 | 155-0015-01 |
| A15A1U2185 | 155-0014-01 | | | MICROCKT,DGTL:A-D CONVERTER | 80009 | 155-0014-01 |
| A15A1U2186 | 156-1177-01 | B030000 | | MICROCKT,DGTL:STET LINE PRIORITY ENCODER | 01295 | SN74LS147NP3 |
| A15A1U2190 | 155-0015-01 | | | MICROCKT,DGTL:ANALOG DATA SWITCH | 80009 | 155-0015-01 |
| A15A1U2202 | 156-1172-01 | B030000 | B042099 | MICROCKT,DGTL:DUAL 4 BIT BIN CNTR,SCRN | 80009 | 156-1172-01 |
| A15A1U2202 | 156-1172-02 | B042100 | | MICROCKT,DGTL:DUAL 4-STAGE BIN CNTR,SCRN | 80009 | 156-1172-02 |
| A15A1U2203 | 160-2997-00 | B030000 | B042193 | MICROCKT,DGTL:4096 X 8 EPROM,PRGM | 80009 | 160-2997-00 |
| A15A1U2203 | 160-2997-01 | B042194 | | MICROCKT,DGTL:4096 X 8 PROM,PRGM | 80009 | 160-2997-01 |
| A15A1U2204 | 156-0865-02 | B030000 | | MICROCKT,DGTL:OCTAL D FF W/CLEAR,SCRN | 80009 | 156-0865-02 |
| A15A1U2210 | 156-1191-00 | B030000 | | MICROCKT,LINEAR:BIFET,DUAL OPNL AMPL | 01295 | TL072CP |
| A15A1U2232 | 155-0018-00 | | | MICROCKT,DGTL:ZERO LOGIC | 80009 | 155-0018-00 |
| A15A1U2244 | 155-0014-01 | | | MICROCKT,DGTL:A-D CONVERTER | 80009 | 155-0014-01 |
| A15A1U2246 | 156-1177-01 | B030000 | | MICROCKT,DGTL:STET LINE PRIORITY ENCOOER | 01295 | SN74LS147NP3 |
| A15A1U2250 | 156-0032-03 | B010100 | B029999 | MICROCKT,DGTL:4 BIT BINARY COUNTER | 01295 | SN7493NP3 |
| A15A1U2251 | 156-0730-02 | B030000 | | MICROCKT,DGTL:QUAD 2-INP NOR BFR,SCRN | 80009 | 156-0730-02 |
| A15A1U2257 | 156-1191-00 | B030000 | | MICROCKT,LINEAR:BIFET,DUAL OPNL AMPL | 01295 | TL072CP |
| A15A1U2260 | 155-0019-00 | B010100 | B029999 | MICROCKT,DGTL:DECIMAL POINT & SPACE | 80009 | 155-0019-00 |
| A15A1U2263 | 156-0140-02 | B030000 | | MICROCKT,DGTL:HEX BUFFERS W/OC HV OUT, | 18324 | N7417(NB OR FB) |
| A15A1U2264 | 156-0480-02 | B030000 | | MICROCKT,DGTL:QUAD 2-INP & GATE,SCRN, | 80009 | 156-0480-02 |
| A15A1U2270 | 155-0023-00 | B010100 | B029999 | MICROCKT,DGTL:CHARACTER GENERATOR,NUM | 80009 | 155-0023-00 |
| A15A1U2272 | 155-0024-00 | B010100 | B029999 | MICROCKT,DGTL:CHAR GEN SPCL SYMBOLS | 80009 | 155-0024-00 |
| A15A1U2274 | 155-0025-00 | B010100 | B029999 | MICROCKT,DGTL:CHAR GEN PREFIXES | 80009 | 155-0025-00 |
| A15A1U2276 | 155-0026-00 | B010100 | B029999 | MICROCKT,DGTL:CHARACTER GENERATOR LETTERS | 80009 | 155-0026-00 |
| A15A1U2276 | 156-1191-00 | B030000 | | MICROCKT,LINEAR:BIFET,DUAL OPNL AMPL | 01295 | TL072CP |
| A15A1U2278 | 155-0027-00 | B010100 | B029999 | MICROCKT,DGTL:CHAR GEN SPECIAL ALPHA | 80009 | 155-0027-00 |
| A15A1U2284 | 155-0020-00 | B010100 | B029999 | MICROCKT,DGTL:CHANNEL SW OUTPUT ASSY | 80009 | 155-0020-00 |
| A15A1VR2185 | 152-0405-00 | B030000 | | SEMICONDC DVC,DI:ZEN,SI,15V,5%,1W,T0-41 | 12954 | DZ841205A |
| A15A1VR2186 | 152-0405-00 | B030000 | | SEMICONDC DVC,DI:ZEN,SI,15V,5%,1W,T0-41 | 12954 | DZ841205A |

Replaceable Electrical Parts - 7904A

| Component No. | Tektronix Part No. | Serial/Assembly No. Effective | Discont | Name & Description | Mfr. Code | Mfr. Part No. |
|---------------|--------------------|-------------------------------|---------|---|-----------|-----------------|
| A15A1VR2187 | 152-0405-00 | B030000 | | SEMICON DVC,DI:ZEN,SI,15V,5%,1W,TO-41 | 12954 | DZ841205A |
| A15A1VR2262 | 152-0405-00 | B010100 | B029999 | SEMICON DVC,DI:ZEN,SI,15V,5%,1W,TO-41 | 12954 | DZ841205A |
| A15A1VR2263 | 152-0405-00 | B010100 | B029999 | SEMICON DVC,DI:ZEN,SI,15V,5%,1W,TO-41 | 12954 | DZ841205A |
| A15A1VR2264 | 152-0405-00 | B010100 | B029999 | SEMICON DVC,DI:ZEN,SI,15V,5%,1W,TO-41 | 12954 | DZ841205A |
| A15A1W2127 | 195-2256-00 | B042482 | | LEAD,ELECTRICAL:26 AWG,1.5L,0-N | 80009 | 195-2256-00 |
| A16 | 670-4769-20 | | | CIRCUIT BO ASSY:VERTICAL CHANNEL SWITCH | 80009 | 670-4769-20 |
| A16C505 | 281-0811-00 | | | CAP,FXD,CER DI:10PF,10%,100V | 04222 | MA101A100KAA |
| A16C508 | 281-0775-00 | | | CAP,FXD,CER DI:0.1UF,20%,50V | 04222 | MA205E104MAA |
| A16C512 | 285-0650-00 | | | CAP,FXD,PLASTIC:0.027UF,5%,100V | 56289 | 192P27352M447 |
| A16C515 | 285-0643-00 | | | CAP,FXD,PLASTIC:0.0047UF,5%,100V | 56289 | 192P47252R468 |
| A16C520 | 283-0666-00 | | | CAP,FXD,MICA DI:890PF,2%,100V | 00853 | 0151F891G0 |
| A16C525 | 283-0649-00 | | | CAP,FXD,MICA DI:105PF,1%,500V | 00853 | 0155F1050F0 |
| A16C531 | 285-0598-00 | | | CAP,FXD,PLASTIC:0.01UF,5%,100V | 19396 | DU490B103J |
| A16C538 | 281-0204-00 | | | CAP,VAR,PLASTIC:2-22PF,100V | 19701 | 2807C00222MJ02 |
| A16C539 | 281-0775-00 | | | CAP,FXD,CER DI:0.1UF,20%,50V | 04222 | MA205E104MAA |
| A16C582 | 290-0745-00 | | | CAP,FXD,ELCTLT:22UF,+50-20%,25WVDC | 54473 | ECE-A25V22L |
| A16C583 | 290-0745-00 | | | CAP,FXD,ELCTLT:22UF,+50-20%,25WVDC | 54473 | ECE-A25V22L |
| A16C584 | 290-0745-00 | | | CAP,FXD,ELCTLT:22UF,+50-20%,25WVDC | 54473 | ECE-A25V22L |
| A16C605 | 281-0811-00 | | | CAP,FXD,CER DI:10PF,10%,100V | 04222 | MA101A100KAA |
| A16C608 | 281-0775-00 | | | CAP,FXD,CER DI:0.1UF,20%,50V | 04222 | MA205E104MAA |
| A16C612 | 285-0650-00 | | | CAP,FXD,PLASTIC:0.027UF,5%,100V | 56289 | 192P27352M447 |
| A16C615 | 285-0643-00 | | | CAP,FXD,PLASTIC:0.0047UF,5%,100V | 56289 | 192P47252R468 |
| A16C620 | 283-0666-00 | | | CAP,FXD,MICA DI:890PF,2%,100V | 00853 | D151F891G0 |
| A16C625 | 283-0649-00 | | | CAP,FXD,MICA DI:105PF,1%,500V | 00853 | D155F1050F0 |
| A16C631 | 285-0598-00 | | | CAP,FXD,PLASTIC:0.01UF,5%,100V | 19396 | DU490B103J |
| A16C638 | 281-0204-00 | | | CAP,VAR,PLASTIC:2-22PF,100V | 19701 | 2807C00222MJ02 |
| A16C639 | 281-0775-00 | | | CAP,FXD,CER DI:0.1UF,20%,50V | 04222 | MA205E104MAA |
| A16C675 | 281-0775-00 | | | CAP,FXD,CER DI:0.1UF,20%,50V | 04222 | MA205E104MAA |
| A16C681 | 281-0788-00 | | | CAP,FXD,CER DI:470PF,10%,100V | 04222 | SA102C471KAA |
| A16C695 | 290-0746-00 | | | CAP,FXD,ELCTLT:47UF,+50-20%,16V | 54473 | ECE-AGV47L |
| A16CR552 | 152-0141-02 | | | SEMICON DVC,DI:SW,SI,30V,150MA,30V,DO-35 | 03508 | DA2527 (1N4152) |
| A16CR651 | 152-0141-02 | | | SEMICON DVC,DI:SW,SI,30V,150MA,30V,DO-35 | 03508 | DA2527 (1N4152) |
| A16CR654 | 152-0141-02 | | | SEMICON DVC,DI:SW,SI,30V,150MA,30V,DO-35 | 03508 | DA2527 (1N4152) |
| A16L582 | 108-0538-00 | | | COIL,RF:FIXED,2.7UH | 76493 | JMM#B7059 |
| A16L583 | 108-0538-00 | | | COIL,RF:FIXED,2.7UH | 76493 | JMM#B7059 |
| A16L584 | 108-0538-00 | | | COIL,RF:FIXED,2.7UH | 76493 | JMM#B7059 |
| A16P680 | 131-0608-00 | | | TERMINAL,PIN:0.365 L X 0.025 BRZ GLD PL (QUANTITY OF 7) | 22526 | 48283-036 |
| A16Q542 | 151-0302-00 | | | TRANSISTOR:NPN,SI,TO-18 | 04713 | ST899 |
| A16Q548 | 151-0302-00 | | | TRANSISTOR:NPN,SI,TO-18 | 04713 | ST899 |
| A16Q556 | 151-0302-00 | | | TRANSISTOR:NPN,SI,TO-18 | 04713 | ST899 |
| A16Q558 | 151-0302-00 | | | TRANSISTOR:NPN,SI,TO-18 | 04713 | ST899 |
| A16Q642 | 151-0302-00 | | | TRANSISTOR:NPN,SI,TO-18 | 04713 | ST899 |
| A16Q648 | 151-0302-00 | | | TRANSISTOR:NPN,SI,TO-18 | 04713 | ST899 |
| A16Q656 | 151-0302-00 | | | TRANSISTOR:NPN,SI,TO-18 | 04713 | ST899 |
| A16Q658 | 151-0302-00 | | | TRANSISTOR:NPN,SI,TO-18 | 04713 | ST899 |
| A16Q672 | 151-0301-00 | | | TRANSISTOR:PNP,SI,TO-18 | 80009 | 151-0301-00 |
| A16Q676 | 151-0134-00 | | | TRANSISTOR:PNP,SI,TO-39 | 04713 | SM3195 |
| A16Q682 | 151-0301-00 | | | TRANSISTOR:PNP,SI,TO-18 | 80009 | 151-0301-00 |
| A16R501 | 321-0289-00 | | | RES,FXD,FILM:10.0K OHM,1%,0.125W,TC=TO | 19701 | 5033ED10K0F |
| A16R502 | 321-0289-00 | | | RES,FXD,FILM:10.0K OHM,1%,0.125W,TC=TO | 19701 | 5033ED10K0F |
| A16R504 | 321-0335-00 | | | RES,FXD,FILM:30.1K OHM,1%,0.125W,TC=TO | 57668 | RB14FXE30K1 |
| A16R505 | 321-0335-00 | | | RES,FXD,FILM:30.1K OHM,1%,0.125W,TC=TO | 57668 | RB14FXE30K1 |
| A16R511 | 321-0414-00 | | | RES,FXD,FILM:200K OHM,1%,0.125W,TC=TO | 07716 | CEAD20002F |
| A16R512 | 311-1214-00 | | | RES,VAR,NONWw:TRMR,200K OHM,0.5W | 32997 | 3386F-T04-204 |
| A16R513 | 321-0318-00 | | | RES,FXD,FILM:20.0K OHM,1%,0.125W,TC=TO | 19701 | 5033ED20K0DF |
| A16R514 | 321-0385-00 | | | RES,FXD,FILM:100K OHM,1%,0.125W,TC=TO | 19701 | 5033ED100K0F |
| A16R515 | 311-1235-00 | | | RES,VAR,NONWw:100K OHM,0.5W | 32997 | 3386F-T04-104 |

| Component No. | Tektronix Part No. | Serial/Assembly No. Effective Dscnt | Name & Description | Mfr. Code | Mfr. Part No. |
|---------------|--------------------|-------------------------------------|--|-----------|-----------------|
| A16R516 | 321-0309-00 | | RES,FXD,FILM:16.2K OHM,1%,0.125W,TC=TO | 19701 | 5033ED16K20F |
| A16R519 | 321-0385-00 | | RES,FXD,FILM:100K OHM,1%,0.125W,TC=TO | 19701 | 5033ED100K0F |
| A16R520 | 311-1232-00 | | RES,VAR,NONNW:TRMR,50K OHM,0.5W | 32997 | 3386F-T04-503 |
| A16R521 | 321-0281-00 | | RES,FXD,FILM:8.25K OHM,1%,0.125W,TC=TO | 19701 | 5043ED8K250F |
| A16R524 | 321-0357-00 | | RES,FXD,FILM:51.1K OHM,1%,0.125W,TC=TO | 07716 | CEAD51101F |
| A16R525 | 311-1230-00 | | RES,VAR,NONNW:TRMR,20K OHM,0.5W | 32997 | 3386F-T04-203 |
| A16R526 | 321-0314-00 | | RES,FXD,FILM:18.2K OHM,1%,0.125W,TC=TO | 19701 | 5043ED18K20F |
| A16R529 | 321-0326-00 | | RES,FXD,FILM:24.3K OHM,1%,0.125W,TC=TO | 19701 | 5043ED24K30F |
| A16R530 | 311-1230-00 | | RES,VAR,NONNW:TRMR,20K OHM,0.5W | 32997 | 3386F-T04-203 |
| A16R531 | 321-0450-00 | | RES,FXD,FILM:475K OHM,1%,0.125W,TC=TO | 19701 | 5043ED475K0F |
| A16R532 | 321-0450-00 | | RES,FXD,FILM:475K OHM,1%,0.125W,TC=TO | 19701 | 5043ED475K0F |
| A16R535 | 311-1235-00 | | RES,VAR,NONNW:100K OHM,0.5W | 32997 | 3386F-T04-104 |
| A16R536 | 315-0104-00 | | RES,FXD,FILM:100K OHM,5%,0.25W | 57668 | NTR25J-E100K |
| A16R537 | 315-0244-00 | | RES,FXD,FILM:240K OHM,5%,0.25W | 19701 | 5043CX240K0J |
| A16R538 | 321-0326-00 | | RES,FXD,FILM:24.3K OHM,1%,0.125W,TC=TO | 19701 | 5043ED24K30F |
| A16R542 | 323-0168-00 | | RES,FXD,FILM:549 OHM,1%,0.5W,TC=TO | 19701 | 5053RD549ROF |
| A16R543 | 321-0065-00 | | RES,FXD,FILM:46.4 OHM,1%,0.125W,TC=TO | 57668 | RB14FXE 46E4 |
| A16R547 | 321-0084-00 | | RES,FXD,FILM:73.2 OHM,1%,0.125W,TC=TO | 91637 | CMF55116673R20F |
| A16R548 | 323-0168-00 | | RES,FXD,FILM:549 OHM,1%,0.5W,TC=TO | 19701 | 5053RD549ROF |
| A16R549 | 321-0010-00 | | RES,FXD,FILM:12.4 OHM,1%,0.125W,TC=TO | 57668 | RB14FXE 12E4 |
| A16R550 | 323-0136-00 | | RES,FXD,FILM:255 OHM,1%,0.5W,TC=TO | 24546 | NA65D2550F |
| A16R552 | 315-0512-00 | | RES,FXD,FILM:5.1K OHM,5%,0.25W | 57668 | NTR25J-E05K1 |
| A16R555 | 315-0102-00 | | RES,FXD,FILM:1K OHM,5%,0.25W | 57668 | NTR25JE01K0 |
| A16R556 | 321-0126-00 | | RES,FXD,FILM:200 OHM,1%,0.125W,TC=TO | 19701 | 5033ED200ROF |
| A16R557 | 321-0237-00 | | RES,FXD,FILM:2.87K OHM,1%,0.125W,TC=TO | 07716 | CEAD 28700F |
| A16R558 | 321-0126-00 | | RES,FXD,FILM:200 OHM,1%,0.125W,TC=TO | 19701 | 5033ED200ROF |
| A16R559 | 317-0103-00 | | RES,FXD,CMPSN:10K OHM,5%,0.125W | 01121 | BB1035 |
| A16R601 | 321-0289-00 | | RES,FXD,FILM:10.0K OHM,1%,0.125W,TC=TO | 19701 | 5033ED10K0F |
| A16R602 | 321-0289-00 | | RES,FXD,FILM:10.0K OHM,1%,0.125W,TC=TO | 19701 | 5033ED10K0F |
| A16R604 | 321-0335-00 | | RES,FXD,FILM:30.1K OHM,1%,0.125W,TC=TO | 57668 | RB14FXE30K1 |
| A16R605 | 321-0335-00 | | RES,FXD,FILM:30.1K OHM,1%,0.125W,TC=TO | 57668 | RB14FXE30K1 |
| A16R611 | 321-0414-00 | | RES,FXD,FILM:200K OHM,1%,0.125W,TC=TO | 07716 | CEAD20002F |
| A16R612 | 311-1214-00 | | RES,VAR,NONNW:TRMR,200K OHM,0.5W | 32997 | 3386F-T04-204 |
| A16R613 | 315-0203-00 | | RES,FXD,FILM:20K OHM,5%,0.25W | 57668 | NTR25J-E 20K |
| A16R614 | 321-0385-00 | | RES,FXD,FILM:100K OHM,1%,0.125W,TC=TO | 19701 | 5033ED100K0F |
| A16R615 | 311-1235-00 | | RES,VAR,NONNW:100K OHM,0.5W | 32997 | 3386F-T04-104 |
| A16R616 | 321-0309-00 | | RES,FXD,FILM:16.2K OHM,1%,0.125W,TC=TO | 19701 | 5033ED16K20F |
| A16R619 | 321-0385-00 | | RES,FXD,FILM:100K OHM,1%,0.125W,TC=TO | 19701 | 5033ED100K0F |
| A16R620 | 311-1232-00 | | RES,VAR,NONNW:TRMR,50K OHM,0.5W | 32997 | 3386F-T04-503 |
| A16R621 | 321-0281-00 | | RES,FXD,FILM:8.25K OHM,1%,0.125W,TC=TO | 19701 | 5043ED8K250F |
| A16R624 | 321-0357-00 | | RES,FXD,FILM:51.1K OHM,1%,0.125W,TC=TO | 07716 | CEAD51101F |
| A16R625 | 311-1230-00 | | RES,VAR,NONNW:TRMR,20K OHM,0.5W | 32997 | 3386F-T04-203 |
| A16R626 | 321-0314-00 | | RES,FXD,FILM:18.2K OHM,1%,0.125W,TC=TO | 19701 | 5043ED18K20F |
| A16R629 | 321-0326-00 | | RES,FXD,FILM:24.3K OHM,1%,0.125W,TC=TO | 19701 | 5043ED24K30F |
| A16R630 | 311-1230-00 | | RES,VAR,NONNW:TRMR,20K OHM,0.5W | 32997 | 3386F-T04-203 |
| A16R631 | 321-0450-00 | | RES,FXD,FILM:475K OHM,1%,0.125W,TC=TO | 19701 | 5043ED475K0F |
| A16R632 | 321-0450-00 | | RES,FXD,FILM:475K OHM,1%,0.125W,TC=TO | 19701 | 5043ED475K0F |
| A16R638 | 321-0326-00 | | RES,FXD,FILM:24.3K OHM,1%,0.125W,TC=TO | 19701 | 5043ED24K30F |
| A16R642 | 323-0168-00 | | RES,FXD,FILM:549 OHM,1%,0.5W,TC=TO | 19701 | 5053RD549ROF |
| A16R643 | 321-0065-00 | | RES,FXD,FILM:46.4 OHM,1%,0.125W,TC=TO | 57668 | RB14FXE 46E4 |
| A16R646 | 321-0080-00 | | RES,FXD,FILM:66.5 OHM,1%,0.125W,TC=TO | 91637 | CMF5511666R50F |
| A16R647 | 321-0084-00 | | RES,FXD,FILM:73.2 OHM,1%,0.125W,TC=TO | 91637 | CMF55116673R20F |
| A16R648 | 323-0168-00 | | RES,FXD,FILM:549 OHM,1%,0.5W,TC=TO | 19701 | 5053RD549ROF |
| A16R649 | 321-0010-00 | | RES,FXD,FILM:12.4 OHM,1%,0.125W,TC=TO | 57668 | RB14FXE 12E4 |
| A16R650 | 323-0136-00 | | RES,FXD,FILM:255 OHM,1%,0.5W,TC=TO | 24546 | NA65D2550F |
| A16R651 | 315-0471-00 | | RES,FXD,FILM:470 OHM,5%,0.25W | 57668 | NTR25J-E470E |
| A16R652 | 315-0153-00 | | RES,FXD,FILM:15K OHM,5%,0.25W | 19701 | 5043CX15K00J |
| A16R653 | 315-0472-00 | | RES,FXD,FILM:4.7K OHM,5%,0.25W | 57668 | NTR25J-E04K7 |

Replaceable Electrical Parts - 7904A

| Component No. | Tektronix Part No. | Serial/Assembly No. Effective Dscont | Name & Description | Mfr. Code | Mfr. Part No. |
|---------------|--------------------|--------------------------------------|---|-----------|-----------------|
| A16R654 | 315-0512-00 | | RES,FXD,FILM:5.1K OHM,5%,0.25W | 57668 | NTR25J-E05K1 |
| A16R655 | 315-0102-00 | | RES,FXD,FILM:1K OHM,5%,0.25W | 57668 | NTR25JE01K0 |
| A16R656 | 321-0126-00 | | RES,FXD,FILM:200 OHM,1%,0.125W,TC=TO | 19701 | 5033ED20OROF |
| A16R657 | 321-0237-00 | | RES,FXD,FILM:2.87K OHM,1%,0.125W,TC=TO | 07716 | CEAD 28700F |
| A16R658 | 321-0126-00 | | RES,FXD,FILM:200 OHM,1%,0.125W,TC=TO | 19701 | 5033ED20OROF |
| A16R659 | 317-0103-00 | | RES,FXD,CMPSN:10K OHM,5%,0.125W | 01121 | BB1035 |
| A16R671 | 321-0246-00 | | RES,FXD,FILM:3.57K OHM,1%,0.125W,TC=TO | 19701 | 5043ED3K570F |
| A16R672 | 321-0309-00 | | RES,FXD,FILM:16.2K OHM,1%,0.125W,TC=TO | 19701 | 5033ED16K20F |
| A16R675 | 315-0272-00 | | RES,FXD,FILM:2.7K OHM,5%,0.25W | 57668 | NTR25J-E02K7 |
| A16R680 | 321-0277-03 | | RES,FXD,FILM:7.50K OHM,0.25%,0.125W,TC=T2 | 01121 | ORDER BY DESCR |
| A16R681 | 321-0277-03 | | RES,FXD,FILM:7.50K OHM,0.25%,0.125W,TC=T2 | 01121 | ORDER BY DESCR |
| A16R682 | 315-0471-00 | | RES,FXD,FILM:470 OHM,5%,0.25W | 57668 | NTR25J-E470E |
| A16R683 | 315-0102-00 | | RES,FXD,FILM:1K OHM,5%,0.25W | 57668 | NTR25JE01K0 |
| A16R684 | 307-0053-00 | | RES,FXD,CMPSN:3.3 OHM,5%,0.5W | 01121 | EB33G5 |
| A16R690 | 321-0279-00 | | RES,FXD,FILM:7.87K OHM,1%,0.125W,TC=TO | 07716 | CEAD78700F |
| A16R691 | 321-0322-00 | | RES,FXD,FILM:22.1K OHM,0.1%,0.125W,TC=TO | 19701 | 5033ED22K10F |
| A16R694 | 315-0562-00 | | RES,FXD,FILM:5.6K OHM,5%,0.25W | 57668 | NTR25J-E05K6 |
| A16TP500 | 214-0579-00 | | TERM,TEST POINT:BRS CD PL | 80009 | 214-0579-00 |
| A16TP508 | 214-0579-00 | | TERM,TEST POINT:BRS CD PL | 80009 | 214-0579-00 |
| A16TP538 | 214-0579-00 | | TERM,TEST POINT:BRS CD PL | 80009 | 214-0579-00 |
| A16TP552 | 214-0579-00 | | TERM,TEST POINT:BRS CD PL | 80009 | 214-0579-00 |
| A16TP555 | 214-0579-00 | | TERM,TEST POINT:BRS CD PL | 80009 | 214-0579-00 |
| A16TP582 | 214-0579-00 | | TERM,TEST POINT:BRS CD PL | 80009 | 214-0579-00 |
| A16TP583 | 214-0579-00 | | TERM,TEST POINT:BRS CD PL | 80009 | 214-0579-00 |
| A16TP584 | 214-0579-00 | | TERM,TEST POINT:BRS CD PL | 80009 | 214-0579-00 |
| A16TP600 | 214-0579-00 | | TERM,TEST POINT:BRS CD PL | 80009 | 214-0579-00 |
| A16TP608 | 214-0579-00 | | TERM,TEST POINT:BRS CD PL | 80009 | 214-0579-00 |
| A16TP648 | 214-0579-00 | | TERM,TEST POINT:BRS CD PL | 80009 | 214-0579-00 |
| A16TP657 | 214-0579-00 | | TERM,TEST POINT:BRS CD PL | 80009 | 214-0579-00 |
| A16TP682 | 214-0579-00 | | TERM,TEST POINT:BRS CD PL | 80009 | 214-0579-00 |
| A16TP684 | 214-0579-00 | | TERM,TEST POINT:BRS CD PL | 80009 | 214-0579-00 |
| A16TP694 | 214-0579-00 | | TERM,TEST POINT:BRS CD PL | 80009 | 214-0579-00 |
| A16U508 | 156-1149-00 | | MICROCKT,LINER:OPERATIONAL AMP,JFET INPUT | 27014 | LF351N/GLEA134 |
| A16U538 | 156-1149-00 | | MICROCKT,LINER:OPERATIONAL AMP,JFET INPUT | 27014 | LF351N/GLEA134 |
| A16U608 | 156-1149-00 | | MICROCKT,LINER:OPERATIONAL AMP,JFET INPUT | 27014 | LF351N/GLEA134 |
| A16U638 | 156-1149-00 | | MICROCKT,LINER:OPERATIONAL AMP,JFET INPUT | 27014 | LF351N/GLEA134 |
| A16U668 | 155-0173-00 | | MICROCKT,LINER:VERTICAL CHANNEL SWITCH | 80009 | 155-0173-00 |
| A16U682 | 156-0067-00 | | MICROCKT,LINER:BIPOLAR,OPNL AMPL | 04713 | MC1741CP1 |
| A16U694 | 156-0067-00 | | MICROCKT,LINER:BIPOLAR,OPNL AMPL | 04713 | MC1741CP1 |
| A17 | 670-1633-00 | | CIRCUIT BD ASSY:X+Y DELAY COMPENSATION (OPTION 02 ONLY) | 80009 | 67D-1633-00 |
| A17C803 | 283-0603-00 | | CAP,FXD,MICA DI:113PF,2%,300V | 00853 | D155F1130G0 |
| A17C804 | 281-0118-00 | | CAP,VAR,MICA DI:8-90PF,175V | 52769 | GSM231 |
| A17C806 | 283-0677-00 | | CAP,FXD,MICA DI:82PF,1%,500V | 00853 | D155E820F0 |
| A17C807 | 283-0668-00 | | CAP,FXD,MICA DI:184PF,1%,100V | 00853 | D155F1840F0 |
| A17C808 | 283-0668-00 | | CAP,FXD,MICA DI:184PF,1%,100V | 00853 | D155F1840F0 |
| A17C809 | 283-0677-00 | | CAP,FXD,MICA DI:82PF,1%,500V | 00853 | D155E820F0 |
| A17C813 | 283-0603-00 | | CAP,FXD,MICA DI:113PF,2%,300V | 00853 | D155F1130G0 |
| A17C814 | 281-0118-00 | | CAP,VAR,MICA DI:8-90PF,175V | 52769 | GSM231 |
| A17C816 | 283-0677-00 | | CAP,FXD,MICA DI:82PF,1%,500V | 00853 | D155E820F0 |
| A17C817 | 283-0668-00 | | CAP,FXD,MICA DI:184PF,1%,100V | 00853 | D155F1840F0 |
| A17C818 | 283-0668-00 | | CAP,FXD,MICA DI:184PF,1%,100V | 00853 | D155F1840F0 |
| A17C819 | 283-0677-00 | | CAP,FXD,MICA DI:82PF,1%,500V | 00853 | D155E820F0 |
| A17CR801 | 152-0141-02 | | SEMICON DVC,DI:SW,SI,30V,150MA,30V,DO-35 | 03508 | DA2527 (1N4152) |
| A17CR811 | 152-0141-02 | | SEMICON DVC,DI:SW,SI,30V,150MA,30V,DO-35 | 03508 | DA2527 (1N4152) |
| A17K802 | 148-0034-00 | | RELAY,ARMATURE:DPDT,15VDC,600 OHM | 80009 | 148-0034-00 |
| A17K805 | 148-0034-00 | | RELAY,ARMATURE:DPDT,15VDC,600 OHM | 80009 | 148-0034-00 |
| A17K812 | 148-0034-00 | | RELAY,ARMATURE:DPDT,15VDC,600 OHM | 80009 | 148-0034-00 |

| Component No. | Tektronix Part No. | Serial/Assembly No. Effective Dscont | Name & Description | Mfr. Code | Mfr. Part No. |
|---------------|--------------------|--------------------------------------|---|-----------|-----------------|
| A17K815 | 148-0034-00 | | RELAY,ARMATURE:DPDT,15VDC,600 OHM | 80009 | 148-0034-00 |
| A17L802 | 108-0719-00 | | COIL,RF:FIXED,805NH | TK1345 | 108-0719-00 |
| A17L805 | 108-0719-00 | | COIL,RF:FIXED,805NH | TK1345 | 108-0719-00 |
| A17L806 | 108-0718-00 | | COIL,RF:FIXED,1.75UH | TK1345 | 108-0718-00 |
| A17L807 | 108-0719-00 | | COIL,RF:FIXED,805NH | TK1345 | 108-0719-00 |
| A17L808 | 108-0719-00 | | COIL,RF:FIXED,805NH | TK1345 | 108-0719-00 |
| A17L809 | 108-0718-00 | | COIL,RF:FIXED,1.75UH | TK1345 | 108-0718-00 |
| A17L812 | 108-0719-00 | | COIL,RF:FIXED,805NH | TK1345 | 108-0719-00 |
| A17L815 | 108-0719-00 | | COIL,RF:FIXED,805NH | TK1345 | 108-0719-00 |
| A17L816 | 108-0718-00 | | COIL,RF:FIXED,1.75UH | TK1345 | 108-0718-00 |
| A17L817 | 108-0719-00 | | COIL,RF:FIXED,805NH | TK1345 | 108-0719-00 |
| A17L818 | 108-0719-00 | | COIL,RF:FIXED,805NH | TK1345 | 108-0719-00 |
| A17L819 | 108-0718-00 | | COIL,RF:FIXED,1.75UH | TK1345 | 108-0718-00 |
| A17R802 | 321-0068-00 | | RES,FXD,FILM:49.9 OHM,0.5%,0.125W,TC=TO | 91637 | CMF55116G49R90F |
| A17R805 | 321-0068-00 | | RES,FXD,FILM:49.9 OHM,0.5%,0.125W,TC=TO | 91637 | CMF55116G49R90F |
| A17R812 | 321-0068-00 | | RES,FXD,FILM:49.9 OHM,0.5%,0.125W,TC=TO | 91637 | CMF55116G49R90F |
| A17R815 | 321-0068-00 | | RES,FXD,FILM:49.9 OHM,0.5%,0.125W,TC=TO | 91637 | CMF55116G49R90F |
| A17S801 | 260-0723-00 | | SWITCH,SLIDE:DPDT,0.5A,125VAC | 79727 | GF126-0028 |
| A17S811 | 260-0723-00 | | SWITCH,SLIDE:DPDT,0.5A,125VAC | 79727 | GF126-0028 |
| A18 | 670-7922-00 | | CIRCUIT BD ASSY:VERT AMP (PART OF 672-1176-00) | 80009 | 670-7922-00 |
| A18C100 | 281-0775-00 | | CAP,FXD,CER DI:0.1UF,20%,50V | 04222 | MA205E104MAA |
| A18C120 | 285-0683-00 | | CAP,FXD,PLASTIC:0.022UF,5%,100V | 19396 | 223J01PT485 |
| A18C130 | 285-0686-00 | | CAP,FXD,PLASTIC:0.068UF,10%,100V | 19396 | 683K01PT605 |
| A18C145 | 283-0178-00 | | CAP,FXD,CER DI:0.1UF,20%,100V | 05397 | C330C104Z1U1CA |
| A18C200 | 281-0158-00 | | CAP,VAR,CER DI:7-45PF,100WVDC SUBMIN CER | 59660 | 518-006 G 7-45 |
| A18C201 | 281-0775-00 | | CAP,FXD,CER DI:0.1UF,20%,50V | 04222 | MA205E104MAA |
| A18C202 | 283-0315-00 | | CAP,FXD,CER DI:470PF,10%,100V | 04222 | 10051A471KA2065 |
| A18C203 | 283-0314-00 | | CAP,FXD,CER DI:100PF,10%,100V | 04222 | 08051A101KA2075 |
| A18C204 | 283-0407-00 | | CAP,FXD,CER DI:27PF,5%,50V | 04222 | ULA105A270J8 |
| A18C215 | 281-0151-00 | | CAP,VAR,CER DI:1-3PF,100V | 51406 | DVJ5126 |
| A18C220 | 283-0315-00 | | CAP,FXD,CER DI:470PF,10%,100V | 04222 | 10051A471KA2065 |
| A18C221 | 283-0314-00 | | CAP,FXD,CER DI:100PF,10%,100V | 04222 | 08051A101KA2075 |
| A18C223 | 283-0407-00 | | CAP,FXD,CER DI:27PF,5%,50V | 04222 | ULA105A270J8 |
| A18C240 | 290-0776-00 | | CAP,FXD,ELCTLT:22UF,+50-20%,10V | 55680 | ULA1A220TAA |
| A18C241 | 285-0643-00 | | CAP,FXD,PLASTIC:0.0047UF,5%,100V | 56289 | 192P47252R468 |
| A18C245 | 290-0745-00 | | CAP,FXD,ELCTLT:22UF,+50-20%,25WVDC | 54473 | ECE-A25V22L |
| A18C246 | 290-0745-00 | | CAP,FXD,ELCTLT:22UF,+50-20%,25WVDC | 54473 | ECE-A25V22L |
| A18C333 | 283-0649-00 | | CAP,FXD,MICA DI:105PF,1%,500V | 00853 | D155F1050F0 |
| A18C334 | 281-0810-00 | | CAP,FXD,CER DI:5.6PF,+/-0.5PF,100V | 04222 | MA101A5R6DAA |
| A18C340 | 283-0666-00 | | CAP,FXD,MICA DI:890PF,2%,100V | 00853 | D151F891G0 |
| A18C341 | 281-0775-00 | | CAP,FXD,CER DI:0.1UF,20%,50V | 04222 | MA205E104MAA |
| A18C400 | 283-0256-00 | | CAP,FXD,CER DI:130PF,5%,100V | 51642 | 200100N1500131J |
| A18C401 | 281-0158-00 | | CAP,VAR,CER DI:7-45PF,100WVDC SUBMIN CER | 59660 | 518-006 G 7-45 |
| A18C530 | 281-0775-00 | | CAP,FXD,CER DI:0.1UF,20%,50V | 04222 | MA205E104MAA |
| A18C605 | 290-0782-00 | | CAP,FXD,ELCTLT:4.7UF,+75-20%,35VDC | 55680 | ULB1V4R7TAAANA |
| A18C630 | 281-0771-00 | | CAP,FXD,CER DI:2200PF,20%,200V | 04222 | SA106E222MAA |
| A18C640 | 281-0814-00 | | CAP,FXD,CER DI:100 PF,10%,100V | 04222 | MA101A101KAA |
| A18C700 | 281-0775-00 | | CAP,FXD,CER DI:0.1UF,20%,50V | 04222 | MA205E104MAA |
| A18C712 | 281-0773-00 | | CAP,FXD,CER DI:0.01UF,10%,100V | 04222 | MA201C103KAA |
| A18C742 | 281-0812-00 | | CAP,FXD,CER DI:1000PF,10%,100V | 04222 | MA101C102KAA |
| A18CR333 | 152-0322-00 | | SEMICON DVC,DI:SCHOTTKY,SI,15V,1.2PF,DO-35 | 50434 | 5082-2672 |
| A18CR334 | 152-0322-00 | | SEMICON DVC,DI:SCHOTTKY,SI,15V,1.2PF,DO-35 | 50434 | 5082-2672 |
| A18CR544 | 152-0141-02 | | SEMICON DVC,DI:SW,SI,30V,150MA,30V,DO-35 | 03508 | DA2527 (1N4152) |
| A18CR641 | 152-0141-02 | | SEMICON DVC,DI:SW,SI,30V,150MA,30V,DO-35 | 03508 | DA2527 (1N4152) |
| A18J9 | 131-2020-00 | | CONTACT,ELEC:DUAL,TOP,BERYLLIUM COPPER | 80009 | 131-2020-00 |
| A18J10 | 131-2022-00 | | CONTACT,ELEC:DUAL,BOTTOM,CU BE | 80009 | 131-2022-00 |
| A18J11 | 131-1003-00 | | CONN,RCPT,ELEC:CKT BD MT,3 PRONG | 80009 | 131-1003-00 |

Replaceable Electrical Parts - 7904A

| Component No. | Tektronix Part No. | Serial/Assembly No. Effective Dscont | Name & Description | Mfr. Code | Mfr. Part No. |
|---------------|--------------------|--------------------------------------|---|-----------|-----------------|
| A18J26 | 131-1003-00 | | CONN,RCPT,ELEC:CKT BD MT,3 PRONG | 80009 | 131-1003-00 |
| A18J43 | 131-1003-00 | | CONN,RCPT,ELEC:CKT BD MT,3 PRONG | 80009 | 131-1003-00 |
| A18L100 | 114-0220-00 | | COIL,RF:VARIABLE,1-3UH | 80009 | 114-0220-00 |
| A18L135 | 108-0538-00 | | COIL,RF:FIXED,2.7UH | 76493 | JWM#B7059 |
| A18L140 | 108-0538-00 | | COIL,RF:FIXED,2.7UH | 76493 | JWM#B7059 |
| A18L141 | 108-0538-00 | | COIL,RF:FIXED,2.7UH | 76493 | JWM#B7059 |
| A18L200 | 108-0733-00 | | COIL,RF:FIXED,117NH | 80009 | 108-0733-00 |
| A18L201 | 108-0311-00 | | COIL,RF:FIXED,150NH | TK1345 | 108-0311-00 |
| A18L220 | 108-0733-00 | | COIL,RF:FIXED,117NH | 80009 | 108-0733-00 |
| A18L221 | 108-0311-00 | | COIL,RF:FIXED,150NH | TK1345 | 108-0311-00 |
| A18LR530 | 108-0543-00 | | COIL,RF:FIXED,1.1UH | TK1345 | 108-0543-00 |
| A18P80 | 131-0608-00 | | TERMINAL,PIN:0.365 L X 0.025 BRZ GLD PL (QUANTITY OF 4) | 22526 | 48283-036 |
| A18P190 | 131-0608-00 | | TERMINAL,PIN:0.365 L X 0.025 BRZ GLD PL (QUANTITY OF 2) | 22526 | 48283-036 |
| A18P207 | 131-0608-00 | | TERMINAL,PIN:0.365 L X 0.025 BRZ GLD PL (QUANTITY OF 7) | 22526 | 48283-036 |
| A18Q303 | 151-0302-00 | | TRANSISTOR:NPN,SI,TO-18 | 04713 | ST899 |
| A18Q400 | 151-0302-00 | | TRANSISTOR:NPN,SI,TO-18 | 04713 | ST899 |
| A18Q430 | 151-0192-00 | | TRANSISTOR:NPN,SI,TO-92 | 04713 | SPS8801 |
| A18Q431 | 151-0192-00 | | TRANSISTOR:NPN,SI,TO-92 | 04713 | SPS8801 |
| A18Q435 | 151-0216-00 | | TRANSISTOR:PNP,SI,TO-92 | 04713 | SPS8803 |
| A18Q530 | 151-0216-00 | | TRANSISTOR:PNP,SI,TO-92 | 04713 | SPS8803 |
| A18Q540 | 151-0301-00 | | TRANSISTOR:PNP,SI,TO-18 | 80009 | 151-0301-00 |
| A18Q541 | 151-0302-00 | | TRANSISTOR:NPN,SI,TO-18 | 04713 | ST899 |
| A18Q630 | 151-0221-00 | | TRANSISTOR:PNP,SI,TO-92 | 80009 | 151-0221-00 |
| A18Q631 | 151-0367-00 | | TRANSISTOR:NPN,SI,TO-92 | 04713 | SPS 8811 |
| A18Q720 | 151-0390-00 | | TRANSISTOR:DARLINGTON,NPN,SI | 04713 | SPS34140RMP5U45 |
| A18Q722 | 151-0126-00 | | TRANSISTOR:NPN,SI,TO-18 | 04713 | ST1046 |
| A18Q740 | 151-1021-00 | | TRANSISTOR:FET,N-CHAN,SI,TO-18 | 80009 | 151-1021-00 |
| A18R130 | 311-1230-00 | | RES,VAR,NONWV:TRMR,20K OHM,0.5W | 32997 | 3386F-T04-203 |
| A18R131 | 311-1214-00 | | RES,VAR,NONWV:TRMR,200K OHM,0.5W | 32997 | 3386F-T04-204 |
| A18R132 | 311-1214-00 | | RES,VAR,NONWV:TRMR,200K OHM,0.5W | 32997 | 3386F-T04-204 |
| A18R201 | 315-0101-00 | | RES,FXD,FILM:100 OHM,5%,0.25W | 57668 | NTR25J-E 100E |
| A18R205 | 322-0133-00 | | RES,FXD,FILM:237 OHM,1%,0.25W,TC=TO | 75042 | CEB10-2370F |
| A18R206 | 321-0331-00 | | RES,FXD,FILM:27.4K OHM,1%,0.125W,TC=TO | 19701 | 5043ED27K40F |
| A18R207 | 321-0171-00 | | RES,FXD,FILM:590 OHM,1%,0.125W,TC=TO | 19701 | 5033ED590R0F |
| A18R208 | 317-0047-00 | | RES,FXD,CMPSN:4.7 OHM,5%,0.125W | 01121 | BB4765 |
| A18R209 | 317-0100-00 | | RES,FXD,CMPSN:10 OHM,5%,0.125W | 01121 | BB1005 |
| A18R210 | 317-0150-00 | | RES,FXD,CMPSN:15 OHM,5%,0.125W | 01121 | BB1505 |
| A18R211 | 311-1757-00 | | RES,VAR,NONWV:2.5K OHM 10%,.5W LIN,CERMET | 73138 | 82PR2.5K-124C |
| A18R212 | 321-0172-00 | | RES,FXD,FILM:604 OHM,1%,0.125W,TC=TO | 19701 | 5033ED604R0F |
| A18R213 | 321-0179-00 | | RES,FXD,FILM:715 OHM,1%,0.125W,TC=TO | 07716 | CEAD715R0F |
| A18R214 | 315-0181-00 | | RES,FXD,FILM:180 OHM,5%,0.25W | 57668 | NTR25J-E180E |
| A18R215 | 311-0978-00 | | RES,VAR,NONWV:TRMR,250 OHM,0.5W | 73138 | 82PR250-37C |
| A18R220 | 321-0171-00 | | RES,FXD,FILM:590 OHM,1%,0.125W,TC=TO | 19701 | 5033ED590R0F |
| A18R221 | 317-0047-00 | | RES,FXD,CMPSN:4.7 OHM,5%,0.125W | 01121 | BB4765 |
| A18R222 | 317-0100-00 | | RES,FXD,CMPSN:10 OHM,5%,0.125W | 01121 | BB1005 |
| A18R223 | 317-0150-00 | | RES,FXD,CMPSN:15 OHM,5%,0.125W | 01121 | BB1505 |
| A18R230 | 321-0365-00 | | RES,FXD,FILM:61.9K OHM,1%,0.125W,TC=TO | 07716 | CEAD61901F |
| A18R231 | 321-0361-00 | | RES,FXD,FILM:56.2K OHM,1%,0.125W,TC=TO | 07716 | CEAD56201F |
| A18R232 | 321-0402-00 | | RES,FXD,FILM:150K OHM,1%,0.125W,TC=TO | 19701 | 5033ED150K0F |
| A18R233 | 321-0435-00 | | RES,FXD,FILM:332K OHM,1%,0.125W,TC=TO | 07716 | CEAD33202F |
| A18R234 | 321-0357-00 | | RES,FXD,FILM:51.1K OHM,1%,0.125W,TC=TO | 07716 | CEAD51101F |
| A18R235 | 321-0357-00 | | RES,FXD,FILM:51.1K OHM,1%,0.125W,TC=TO | 07716 | CEAD51101F |
| A18R236 | 321-0357-00 | | RES,FXD,FILM:51.1K OHM,1%,0.125W,TC=TO | 07716 | CEAD51101F |
| A18R237 | 311-1214-00 | | RES,VAR,NONWV:TRMR,200K OHM,0.5W | 32997 | 3386F-T04-204 |
| A18R238 | 311-1214-00 | | RES,VAR,NONWV:TRMR,200K OHM,0.5W | 32997 | 3386F-T04-204 |

| Component No. | Tektronix Part No. | Serial/Assembly No. Effective Dscort | Name & Description | Mfr. Code | Mfr. Part No. |
|---------------|--------------------|--------------------------------------|---|-----------|-----------------|
| A18R300 | 322-0133-00 | | RES,FXD,FILM:237 OHM,1%,0.25W,TC=TO | 75042 | CEBT0-2370F |
| A18R304 | 317-0100-00 | | RES,FXD,CMPSN:10 OHM,5%,0.125W | 01121 | BB1005 |
| A18R310 | 321-0164-00 | | RES,FXD,FILM:499 OHM,1%,0.125W,TC=TO | 19701 | 5033ED499ROF |
| A18R311 | 321-0239-00 | | RES,FXD,FILM:3.01K OHM,1%,0.125W,TC=TO | 19701 | 5043ED3K010F |
| A18R312 | 323-0115-00 | | RES,FXD,FILM:154 OHM,1%,0.5W,TC=TO | 91637 | MFF1226G154ROF |
| A18R320 | 321-0164-00 | | RES,FXD,FILM:499 OHM,1%,0.125W,TC=TO | 19701 | 5033ED499ROF |
| A18R321 | 321-0193-00 | | RES,FXD,FILM:1K OHM,1%,0.125W,TC=TO | 19701 | 5033ED1K00F |
| A18R330 | 321-0354-00 | | RES,FXD,FILM:47.5K OHM,1%,0.125W,TC=TO | 19701 | 5043ED47K50F |
| A18R331 | 321-0342-00 | | RES,FXD,FILM:35.7K OHM,1%,0.125W,TC=TO | 07716 | CEAD35701F |
| A18R332 | 321-0357-00 | | RES,FXD,FILM:51.1K OHM,1%,0.125W,TC=TO | 07716 | CEAD51101F |
| A18R333 | 321-0339-00 | | RES,FXD,FILM:33.2K OHM,1%,0.125W,TC=TO | 07716 | CEAD33201F |
| A18R334 | 321-0239-00 | | RES,FXD,FILM:3.01K OHM,1%,0.125W,TC=TO | 19701 | 5043ED3K010F |
| A18R335 | 311-1214-00 | | RES,VAR,NONW:TRMR,200K OHM,0.5W | 32997 | 3386F-T04-204 |
| A18R336 | 321-0193-00 | | RES,FXD,FILM:1K OHM,1%,0.125W,TC=TO | 19701 | 5033ED1K00F |
| A18R400 | 321-0123-00 | | RES,FXD,FILM:187 OHM,1%,0.125W,TC=TO | 07716 | CEAD187ROF |
| A18R404 | 311-1266-00 | | RES,VAR,NONW:TRMR,2.5K OHM,0.5W | 32997 | 3329P-L58-252 |
| A18R405 | 311-0978-00 | | RES,VAR,NONW:TRMR,250 OHM,0.5W | 73138 | 82PR250-37C |
| A18R406 | 317-0100-00 | | RES,FXD,CMPSN:10 OHM,5%,0.125W | 01121 | BB1005 |
| A18R407 | 317-0100-00 | | RES,FXD,CMPSN:10 OHM,5%,0.125W | 01121 | BB1005 |
| A18R408 | 317-0100-00 | | RES,FXD,CMPSN:10 OHM,5%,0.125W | 01121 | BB1005 |
| A18R430 | 321-0233-00 | | RES,FXD,FILM:2.61K OHM,1%,0.125W,TC=TO | 07716 | CEAD26100F |
| A18R431 | 323-0141-00 | | RES,FXD,FILM:287 OHM,1%,0.5W,TC=TO | 24546 | NA65D 2870F |
| A18R432 | 321-0189-00 | | RES,FXD,FILM:909 OHM,1%,0.125W,TC=TO | 19701 | 5033ED909ROF |
| A18R433 | 321-0208-00 | | RES,FXD,FILM:1.43K OHM,1%,0.125W,TC=TO | 19701 | 5033ED1K43F |
| A18R434 | 321-0208-00 | | RES,FXD,FILM:1.43K OHM,1%,0.125W,TC=TO | 19701 | 5033ED1K43F |
| A18R435 | 321-0184-00 | | RES,FXD,FILM:806 OHM,1%,0.125W,TC=TO | 19701 | 5033ED806ROF |
| A18R437 | 321-0233-00 | | RES,FXD,FILM:2.61K OHM,1%,0.125W,TC=TO | 07716 | CEAD26100F |
| A18R438 | 321-0172-00 | | RES,FXD,FILM:604 OHM,1%,0.125W,TC=TO | 19701 | 5033ED604ROF |
| A18R439 | 321-0114-00 | | RES,FXD,FILM:150 OHM,1%,0.125 W,TC=TO | 19701 | 5033ED150ROF |
| A18R500 | 322-0147-00 | | RES,FXD,FILM:332 OHM,1%,0.25W,TC=TO | 24546 | NA6003320F |
| A18R501 | 322-0147-00 | | RES,FXD,FILM:332 OHM,1%,0.25W,TC=TO | 24546 | NA6003320F |
| A18R502 | 315-0122-00 | | RES,FXD,FILM:1.2K OHM,5%,0.25W | 57668 | NTR25J-E01K2 |
| A18R530 | 321-0210-00 | | RES,FXD,FILM:1.50K OHM,1%,0.125W,TC=TO | 19701 | 5033ED1K50F |
| A18R531 | 321-0140-00 | | RES,FXD,FILM:280 OHM,1%,0.125W,TC=TO | 07716 | CEAD280ROF |
| A18R532 | 322-0216-00 | | RES,FXD,FILM:1.74K OHM,1%,0.25W,TC=TO | 75042 | CEBT0-1741F |
| A18R533 | 322-0201-00 | | RES,FXD,FILM:1.21K OHM,1%,0.25W,TC=TO | 19701 | 5043RD1K210F |
| A18R534 | 321-0309-00 | | RES,FXD,FILM:16.2K OHM,1%,0.125W,TC=TO | 19701 | 5033ED16K20F |
| A18R535 | 321-0161-00 | | RES,FXD,FILM:464 OHM,1%,0.125W,TC=TO | 07716 | CEAD464ROF |
| A18R537 | 321-0100-00 | | RES,FXD,FILM:107 OHM,1%,0.125W,TC=TO | 07716 | CEAD107ROF |
| A18R541 | 315-0623-00 | | RES,FXD,FILM:62K OHM,5%,0.25W | 19701 | 5043CX62K00J |
| A18R543 | 315-0471-00 | | RES,FXD,FILM:470 OHM,5%,0.25W | 57668 | NTR25J-E470E |
| A18R544 | 315-0432-00 | | RES,FXD,FILM:4.3K OHM,5%,0.25W | 57668 | NTR25J-E04K3 |
| A18R600 | 321-0044-00 | | RES,FXD,FILM:28.0 OHM,1%,0.125W,TC=TO | 91637 | CMF55116G2BRDDF |
| A18R601 | 321-0044-00 | | RES,FXD,FILM:28.0 OHM,1%,0.125W,TC=TO | 91637 | CMF55116G28R00F |
| A18R602 | 321-0299-00 | | RES,FXD,FILM:12.7K OHM,1%,0.125W,TC=TO | 19701 | 5033ED12K70F |
| A18R603 | 321-0306-00 | | RES,FXD,FILM:15.0K OHM,1%,0.125W,TC=TO | 19701 | 5033ED15J00F |
| A18R604 | 321-0306-00 | | RES,FXD,FILM:15.0K OHM,1%,0.125W,TC=TO | 19701 | 5033ED15J00F |
| A18R605 | 321-0306-00 | | RES,FXD,FILM:15.0K OHM,1%,0.125W,TC=TO | 19701 | 5033ED15J00F |
| A18R630 | 321-0365-00 | | RES,FXD,FILM:61.9K OHM,1%,0.125W,TC=TO | 07716 | CEAD61901F |
| A18R631 | 321-0160-00 | | RES,FXD,FILM:453 OHM,1%,0.125W,MI | 19701 | 5033ED453ROF |
| A18R632 | 321-0193-00 | | RES,FXD,FILM:1K OHM,1%,0.125W,TC=TO | 19701 | 5033ED1K00F |
| A18R633 | 321-0347-00 | | RES,FXD,FILM:40.2K OHM,1%,0.125W,TC=TO | 91637 | CMF55116G40201F |
| A18R634 | 321-0318-00 | | RES,FXD,FILM:20.0K OHM,1%,0.125W,TC=TO | 19701 | 5033ED20K00F |
| A18R640 | 315-0302-00 | | RES,FXD,FILM:3K OHM,5%,0.25W | 57668 | NTR25J-E03K0 |
| A18R641 | 315-0102-00 | | RES,FXD,FILM:1K OHM,5%,0.25W | 57668 | NTR25JE01K0 |
| A18R642 | 315-0153-00 | | RES,FXD,FILM:15K OHM,5%,0.25W | 19701 | 5043CX15K00J |
| A18R643 | 321-0068-00 | | RES,FXD,FILM:49.9 OHM,0.5%,0.125W,TC=TO | 91637 | CMF55116G49R90F |
| A18R700 | 315-0752-00 | | RES,FXD,FILM:7.5K OHM,5%,0.25W | 57668 | NTR25J-E07K5 |

Replaceable Electrical Parts - 7904A

| Component No. | Tektronix Part No. | Serial/Assembly No. Effective | Discont | Name & Description | Mfr. Code | Mfr. Part No. |
|---------------|--------------------|-------------------------------|---------|--|-----------|------------------|
| A18R701 | 315-0122-00 | | | RES,FXD,FILM:1.2K OHM,5%,0.25W | 57668 | NTR25J-E01K2 |
| A18R702 | 321-0297-00 | | | RES,FXD,FILM:12.1K OHM,1%,0.125W,TC=TO | 07716 | CEAD12101F |
| A18R703 | 321-0320-00 | | | RES,FXD,FILM:21.0K OHM,1%,0.125W,TC=TO | 19701 | 5033ED21K00F |
| A18R710 | 323-0082-00 | | | RES,FXD,FILM:69.8 OHM,1%,0.5W,TC=TO | 24546 | NA65D69R8F |
| A18R711 | 323-0082-00 | | | RES,FXD,FILM:69.8 OHM,1%,0.5W,TC=TO | 24546 | NA65D69R8F |
| A18R712 | 323-0119-00 | | | RES,FXD,FILM:169 OHM,1%,0.5W,TC=TO | 75042 | CECT0-1690F |
| A18R731 | 321-0289-00 | | | RES,FXD,FILM:10.0K OHM,1%,0.125W,TC=TO | 19701 | 5033ED10K0F |
| A18R732 | 321-0324-00 | | | RES,FXD,FILM:23.2K OHM,1%,0.125W,TC=TO | 07716 | CEAD23201F |
| A18R733 | 315-0472-00 | | | RES,FXD,FILM:4.7K OHM,5%,0.25W | 57668 | NTR25J-E04K7 |
| A18R734 | 315-0362-00 | | | RES,FXD,FILM:3.6K OHM,5%,0.25W | 19701 | 5043CX3K600J |
| A18R735 | 315-0362-00 | | | RES,FXD,FILM:3.6K OHM,5%,0.25W | 19701 | 5043CX3K600J |
| A18R736 | 311-1232-00 | | | RES,VAR,NONWw:TRMR,50K OHM,0.5W | 32997 | 3386F-T04-503 |
| A18R737 | 311-1232-00 | | | RES,VAR,NONWw:TRMR,50K OHM,0.5W | 32997 | 3386F-T04-503 |
| A18R740 | 315-0203-00 | | | RES,FXD,FILM:20K OHM,5%,0.25W | 57668 | NTR25J-E 20K |
| A18R741 | 315-0204-00 | | | RES,FXD,FILM:200K OHM,5%,0.25W | 19701 | 5043CX200K0J |
| A18R742 | 315-0104-00 | | | RES,FXD,FILM:100K OHM,5%,0.25W | 57668 | NTR25J-E100K |
| A18R744 | 315-0224-00 | | | RES,FXD,FILM:220K OHM,5%,0.25W | 57668 | NTR25J-E220K |
| A18R745 | 315-0102-00 | | | RES,FXD,FILM:1K OHM,5%,0.25W | 57668 | NTR25JE01K0 |
| A18RT303 | 307-0364-00 | | | RES,THERMAL:50 OHM,5%,0.125W | 01295 | T8 1/8 500J |
| A18TP300 | 214-0579-00 | | | TERM,TEST POINT:BRS CD PL | 80009 | 214-0579-00 |
| A18TP500 | 214-0579-00 | | | TERM,TEST POINT:BRS CD PL | 80009 | 214-0579-00 |
| A18TP502 | 214-0579-00 | | | TERM,TEST POINT:BRS CD PL | 80009 | 214-0579-00 |
| A18TP630 | 214-0579-00 | | | TERM,TEST POINT:BRS CD PL | 80009 | 214-0579-00 |
| A18TP700 | 214-0579-00 | | | TERM,TEST POINT:BRS CD PL | 80009 | 214-0579-00 |
| A18TP720 | 214-0579-00 | | | TERM,TEST POINT:BRS CD PL | 80009 | 214-0579-00 |
| A18TP721 | 214-0579-00 | | | TERM,TEST POINT:BRS CD PL | 80009 | 214-0579-00 |
| A18U100 | 156-1149-00 | | | MICROCKT,LINER:OPERATIONAL AMP,JFET INPUT | 27014 | LF351N/GLEA134 |
| A18U335 | 156-1149-00 | | | MICROCKT,LINER:OPERATIONAL AMP,JFET INPUT | 27014 | LF351N/GLEA134 |
| A18U415 | 155-0175-00 | | | MICROCKT,LINER:TRIGGER AMPLIFIER | 80009 | 155-0175-00 |
| A18U515 | 155-0178-05 | | | MICROCKT,LINER:VERTICAL OUTPUT | 80009 | 155-0178-05 |
| A18U630 | 156-1149-00 | | | MICROCKT,LINER:OPERATIONAL AMP,JFET INPUT | 27014 | LF351N/GLEA134 |
| A18U700 | 156-0158-00 | | | MICROCKT,LINER:BIPOLAR,DUAL OPNL AMPL | 04713 | MC1458P1/MC1458U |
| A18W402 | 131-0566-00 | | | BUS,CONDUCTOR:DUMMY RES,0.094 OD X 0.225 L | 24546 | OMA 07 |
| A18W410 | 131-0566-00 | | | BUS,CONDUCTOR:DUMMY RES,0.094 OD X 0.225 L | 24546 | OMA 07 |
| A18W420 | 131-0566-00 | | | BUS,CONDUCTOR:DUMMY RES,0.094 OD X 0.225 L | 24546 | OMA 07 |
| A18W421 | 131-0566-00 | | | BUS,CONDUCTOR:DUMMY RES,0.094 OD X 0.225 L | 24546 | OMA 07 |
| A18W510 | 131-0566-00 | | | BUS,CONDUCTOR:DUMMY RES,0.094 DD X 0.225 L | 24546 | OMA 07 |
| A18W530 | 131-0566-00 | | | BUS,CONDUCTOR:DUMMY RES,0.094 OD X 0.225 L | 24546 | OMA 07 |
| A19 | 670-1634-00 | | | CIRCUIT BD ASSY:HORIZONTAL INTERCONNECT | 80009 | 670-1634-00 |
| A20 | 670-5841-20 | B010100 | B021129 | CIRCUIT BD ASSY:HV | 80009 | 670-5841-20 |
| A20 | 670-5841-21 | B021130 | | CIRCUIT BD ASSY:HV | 80009 | 670-5841-21 |
| A20C9 | 283-0068-00 | | | CAP,FXD,CER DI:0.01UF,+100-0%,500V | 59660 | 871-533E103P |
| A20C10 | 283-0068-00 | | | CAP,FXD,CER DI:0.01UF,+100-0%,500V | 59660 | 871-533E103P |
| A20C11 | 283-0068-00 | | | CAP,FXD,CER DI:0.01UF,+100-0%,500V | 59660 | 871-533E103P |
| A20C22 | 283-0111-00 | | | CAP,FXD,CER DI:0.1UF,20%,50V | 04222 | SR305C104MAA |
| A20C33 | 283-0078-00 | | | CAP,FXD,CER DI:0.001UF,20%,500V | 59660 | 0801 547X5F0102M |
| A20C34 | 283-0068-00 | | | CAP,FXD,CER DI:0.01UF,+100-0%,500V | 59660 | 871-533E103P |
| A20C36 | 283-0271-00 | | | CAP,FXD,CER DI:0.001UF,20%,4000V | 51406 | DHR15Y5S102M-4KV |
| A20C39 | 283-0271-00 | | | CAP,FXD,CER DI:0.001UF,20%,4000V | 51406 | DHR15Y5S102M-4KV |
| A20C42 | 283-0271-00 | | | CAP,FXD,CER DI:0.001UF,20%,4000V | 51406 | DHR15Y5S102M-4KV |
| A20C53 | 283-0279-00 | | | CAP,FXD,CER DI:0.001UF,20%,3000V | 51406 | DHR12Y5S102M3KV |
| A20C64 | 283-0092-00 | | | CAP,FXD,CER DI:0.03UF,+80-20%,200V | 59660 | 845-534Z5U0303Z |
| A20C66 | 283-0271-00 | | | CAP,FXD,CER DI:0.001UF,20%,4000V | 51406 | DHR15Y5S102M-4KV |
| A20C69 | 283-0271-00 | | | CAP,FXD,CER DI:0.001UF,20%,4000V | 51406 | DHR15Y5S102M-4KV |
| A20C72 | 283-0271-00 | | | CAP,FXD,CER DI:0.001UF,20%,4000V | 51406 | DHR15Y5S102M-4KV |
| A20C82 | 283-0105-00 | | | CAP,FXD,CER DI:0.01UF,+80-20%,2000V | 60705 | 564CBA2021P203ZA |
| A20C84 | 283-0272-00 | | | CAP,FXD,CER DI:0.0068UF,30%,4000V | 51406 | DHR28Y5S682M-4 |

| Component No. | Tektronix Part No. | Serial/Assembly No. Effective Dscont | Name & Description | Mfr. Code | Mfr. Part No. |
|---------------|--------------------|--------------------------------------|--|-----------|------------------|
| A20C86 | 283-0272-00 | | CAP,FXD,CER DI:0.0068UF,30%,4000V | 51406 | DHR28Y5S682M-4 |
| A20C87 | 283-0105-00 | | CAP,FXD,CER DI:0.01UF,+80-20%,2000V | 60705 | 564CBA2021P203ZA |
| A20C89 | 283-0272-00 | | CAP,FXD,CER DI:0.0068UF,30%,4000V | 51406 | DHR28Y5S682M-4 |
| A20C91 | 283-0272-00 | | CAP,FXD,CER DI:0.0068UF,30%,4000V | 51406 | DHR28Y5S682M-4 |
| A20C103 | 290-0767-00 | | CAP,FXD,ELCTLT:4.7UF,+75-10%,160VDC | 54473 | ECEA2CS4R7 |
| A20C104 | 290-0767-00 | | CAP,FXD,ELCTLT:4.7UF,+75-10%,160VDC | 54473 | ECEA2CS4R7 |
| A20C112 | 281-0593-00 | | CAP,FXD,CER DI:3.9PF,+/-0.25PF,500V | 52763 | 2RDPLZ007 3P90CC |
| A20C119 | 283-0271-00 | | CAP,FXD,CER DI:0.001UF,20%,4000V | 51406 | DHR15Y5S102M-4KV |
| A20C122 | 283-0000-00 | | CAP,FXD,CER DI:0.001UF,+100-0%,500V | 59660 | 831-610-Y5U0102P |
| A20C127 | 283-0000-00 | | CAP,FXD,CER DI:0.001UF,+100-0%,500V | 59660 | 831-610-Y5U0102P |
| A20C143 | 283-0068-00 | | CAP,FXD,CER DI:0.01UF,+100-0%,500V | 59660 | 871-533E103P |
| A20C144 | 283-0068-00 | | CAP,FXD,CER DI:0.01UF,+100-0%,500V | 59660 | 871-533E103P |
| A20C156 | 283-0068-00 | | CAP,FXD,CER DI:0.01UF,+100-0%,500V | 59660 | 871-533E103P |
| A20C159 | 283-0068-00 | | CAP,FXD,CER DI:0.01UF,+100-0%,500V | 59660 | 871-533E103P |
| A20CR17 | 152-0242-00 | | SEMICON DVC,DI:SIG,SI,225V,0.2A,DO-7 | 07263 | FDH5004 |
| A20CR18 | 152-0242-00 | | SEMICON DVC,DI:SIG,SI,225V,0.2A,DO-7 | 07263 | FDH5004 |
| A20CR19 | 152-0242-00 | | SEMICON DVC,DI:SIG,SI,225V,0.2A,DO-7 | 07263 | FDH5004 |
| A20CR33 | 152-0242-00 | | SEMICON DVC,DI:SIG,SI,225V,0.2A,DO-7 | 07263 | FDH5004 |
| A20CR34 | 152-0242-00 | | SEMICON DVC,DI:SIG,SI,225V,0.2A,DO-7 | 07263 | FDH5004 |
| A20CR37 | 152-0242-00 | | SEMICON DVC,DI:SIG,SI,225V,0.2A,DO-7 | 07263 | FDH5004 |
| A20CR38 | 152-0242-00 | | SEMICON DVC,DI:SIG,SI,225V,0.2A,DO-7 | 07263 | FDH5004 |
| A20CR51 | 152-0242-00 | | SEMICON DVC,DI:SIG,SI,225V,0.2A,DO-7 | 07263 | FDH5004 |
| A20CR63 | 152-0242-00 | | SEMICON DVC,DI:SIG,SI,225V,0.2A,DO-7 | 07263 | FDH5004 |
| A20CR64 | 152-0242-00 | | SEMICON DVC,DI:SIG,SI,225V,0.2A,DO-7 | 07263 | FDH5004 |
| A20CR67 | 152-0242-00 | | SEMICON DVC,DI:SIG,SI,225V,0.2A,DO-7 | 07263 | FDH5004 |
| A20CR68 | 152-0242-00 | | SEMICON DVC,DI:SIG,SI,225V,0.2A,DO-7 | 07263 | FDH5004 |
| A20CR82 | 152-0639-00 | | SEMICON DVC,DI:RECT,SI,10KV,10MA,RVT1200 | 52306 | CX345 |
| A20CR83 | 152-0639-00 | | SEMICON DVC,DI:RECT,SI,10KV,10MA,RVT1200 | 52306 | CX345 |
| A20CR101 | 152-0586-00 | | SEMICON DVC,DI:RECT,SI,600V,0.5A | 25403 | BYV96D OR BYV95C |
| A20CR102 | 152-0586-00 | | SEMICON DVC,DI:RECT,SI,600V,0.5A | 25403 | BYV96D OR BYV95C |
| A20CR113 | 152-0242-00 | | SEMICON DVC,DI:SIG,SI,225V,0.2A,DO-7 | 07263 | FDH5004 |
| A20CR114 | 152-0242-00 | | SEMICON DVC,DI:SIG,SI,225V,0.2A,DO-7 | 07263 | FDH5004 |
| A20CR124 | 152-0242-00 | | SEMICON DVC,DI:SIG,SI,225V,0.2A,DO-7 | 07263 | FDH5004 |
| A20CR126 | 152-0242-00 | | SEMICON DVC,DI:SIG,SI,225V,0.2A,DO-7 | 07263 | FDH5004 |
| A20CR129 | 152-0066-03 | | SEMICON DVC,DI:RECT,SI,400V,1A,DO-41 | 14433 | LG4017 |
| A20DS45 | 150-0035-00 | | LAMP,GLOW:90V MAX,0.3MA,AID-T,WIRE LD | TK0213 | JH005/3011JA |
| A20DS46 | 150-0035-00 | | LAMP,GLOW:90V MAX,0.3MA,AID-T,WIRE LD | TK0213 | JH005/3011JA |
| A20DS47 | 150-0035-00 | | LAMP,GLOW:90V MAX,0.3MA,AID-T,WIRE LD | TK0213 | JH005/3011JA |
| A20DS75 | 150-0035-00 | | LAMP,GLOW:90V MAX,0.3MA,AID-T,WIRE LD | TK0213 | JH005/3011JA |
| A20DS76 | 150-0035-00 | | LAMP,GLOW:90V MAX,0.3MA,AID-T,WIRE LD | TK0213 | JH005/3011JA |
| A20DS90 | 150-0035-00 | | LAMP,GLOW:90V MAX,0.3MA,AID-T,WIRE LD | TK0213 | JH005/3011JA |
| A20DS113 | 150-0035-00 | | LAMP,GLOW:90V MAX,0.3MA,AID-T,WIRE LD | TK0213 | JH005/3011JA |
| A20P20 | 131-0608-00 | | TERMINAL,PIN:0.365 L X 0.025 BRZ GLD PL (QUANTITY OF 10) | 22526 | 48283-036 |
| A20P35 | 131-0589-00 | | TERMINAL,PIN:0.46 L X 0.025 SQ PH BRZ (QUANTITY OF 5) | 22526 | 48283-029 |
| A20P40 | 131-0589-00 | | TERMINAL,PIN:0.46 L X 0.025 SQ PH BRZ (QUANTITY OF 4) | 22526 | 48283-029 |
| A20P83 | 131-0608-00 | | TERMINAL,PIN:0.365 L X 0.025 BRZ GLD PL (QUANTITY OF 2) | 22526 | 48283-036 |
| A20P146 | 131-0608-00 | | TERMINAL,PIN:0.365 L X 0.025 BRZ GLD PL (QUANTITY OF 5) | 22526 | 48283-036 |
| A20Q129 | 151-0279-00 | | TRANSISTOR:SELECTED | 04713 | SS2821 |
| A20R14 | 308-0123-00 | | RES,FXD,WW:20 OHM,5%,5W | 00213 | 1550S-20-R0-5 |
| A20R16 | 301-0272-02 | | RES,FXD,CMPSN:2.7K OHM,5%,0.5W | 01121 | EB2725 |
| A20R17 | 315-0100-02 | | RES,FXD,CMPSN:10 OHM,5%,0.25W | 01121 | CB1005 |
| A20R18 | 315-0472-03 | | RES,FXD,CMPSN:4.7K OHM,5%,0.25W | 01121 | CB4725 |
| A20R19 | 315-0472-03 | | RES,FXD,CMPSN:4.7K OHM,5%,0.25W | 01121 | CB4725 |
| A20R31 | 301-0155-00 | | RES,FXD,FILM:1.5M OHM,5%,0.5W | 01121 | EB1555 |

Replaceable Electrical Parts - 7904A

| Component No. | Tektronix Part No. | Serial/Assembly No. Effective | Discont | Name & Description | Mfr. Code | Mfr. Part No. |
|---------------|--------------------|-------------------------------|---------|--|-----------|------------------|
| A2OR32 | 301-0155-00 | | | RES,FXD,FILM:1.5M OHM,5%,0.5W | 01121 | EB1555 |
| A2OR33 | 315-0104-03 | | | RES,FXD,CMPSN:100K OHM,5%,0.25W | 01121 | CB1045 |
| A2OR37 | 315-0183-03 | | | RES,FXD,CMPSN:18K OHM,5%,0.25W | 01121 | CB1835 |
| A2OR39 | 315-0226-01 | | | RES,FXD,CMPSN:22 M OHM,5%,0.25W | 01121 | CB2265 |
| A2OR42 | 315-0202-02 | | | RES,FXD,CMPSN:2K OHM,5%,0.25W | 01121 | CB2025 |
| A2OR43 | 315-0104-03 | | | RES,FXD,CMPSN:100K OHM,5%,0.25W | 01121 | CB1045 |
| A2OR44 | 315-0105-03 | | | RES,FXD,CMPSN:1M OHM,5%,0.25W | 80009 | 315-0105-03 |
| A2OR52 | 307-1135-00 | | | RES NTWK,FXD,FI:HIGH VOLTAGE DIVIDER | 80009 | 307-1135-00 |
| A2OR55 | 311-1968-00 | | | RES,VAR,NONNW:PNL,5M OHM,20%,0.5W | 01121 | 72M4N048S505M |
| A2OR61 | 301-0305-01 | | | RES,FXD,CMPSN:3M OHM,5%,0.5W | 01121 | EB3055 |
| A2OR62 | 301-0225-02 | | | RES,FXD,CMPSN:2.2M OHM,5%,0.5W | 01121 | EB2255 |
| A2OR63 | 315-0103-03 | | | RES,FXD,CMPSN:10K OHM,5%,0.25W | 80009 | 315-0103-03 |
| A2OR65 | 311-1284-00 | | | RES,VAR,NONNW:TRMR,20K OHM,0.5W | 32997 | 3329S-L58-203 |
| A2OR66 | 315-0123-00 | | | RES,FXD,FILM:12K OHM,5%,0.25W | 57668 | NTR25J-E12K0 |
| A2OR67 | 315-0183-03 | | | RES,FXD,CMPSN:18K OHM,5%,0.25W | 01121 | CB1835 |
| A2OR69 | 315-0226-01 | | | RES,FXD,CMPSN:22 M OHM,5%,0.25W | 01121 | CB2265 |
| A2OR72 | 315-0101-03 | | | RES,FXD,CMPSN:100 OHM,5%,0.25W | 01121 | CB1015 |
| A2OR73 | 315-0104-03 | | | RES,FXD,CMPSN:100K OHM,5%,0.25W | 01121 | CB1045 |
| A2OR84 | 315-0472-03 | | | RES,FXD,CMPSN:4.7K OHM,5%,0.25W | 01121 | CB4725 |
| A2OR86 | 315-0472-03 | | | RES,FXD,CMPSN:4.7K OHM,5%,0.25W | 01121 | CB4725 |
| A2OR87 | 315-0472-03 | | | RES,FXD,CMPSN:4.7K OHM,5%,0.25W | 01121 | CB4725 |
| A2OR89 | 315-0331-03 | | | RES,FXD,CMPSN:330 OHM 5%,0.25W | 01121 | CB3315 |
| A2OR91 | 315-0101-03 | | | RES,FXD,CMPSN:100 OHM,5%,0.25W | 01121 | CB1015 |
| A2OR92 | 308-0058-00 | | | RES,FXD,WW:1.5 OHM,10%,1W | 75042 | BW-20-1R500K |
| A2OR93 | 315-0104-03 | | | RES,FXD,CMPSN:100K OHM,5%,0.25W | 01121 | CB1045 |
| A2OR103 | 315-0100-02 | | | RES,FXD,CMPSN:10 OHM,5%,0.25W | 01121 | CB1005 |
| A2OR104 | 301-0101-03 | | | RES,FXD,CMPSN:100 OHM,5%,0.5W | 01121 | EB1015 |
| A2OR112 | 315-0136-01 | | | RES,FXD,CMPSN:13M OHM,5%,0.25W | 01121 | CB1365 A.BRADLEY |
| A2OR113 | 315-0203-02 | | | RES,FXD,CMPSN:20K OHM,5%,0.25W | 01121 | CB2035 |
| A2OR115 | 311-1285-00 | | | RES,VAR,NONNW:TRMR,25K OHM,0.5W | 32997 | 3329S-L58-253 |
| A2OR116 | 321-0430-00 | | | RES,FXD,FILM:294K OHM,1%,0.125W,TC=TO | 07716 | CEAD29402F |
| A2OR119 | 301-0102-03 | | | RES,FXD,CMPSN:1K OHM,5%,0.5W | 01121 | EB1025 |
| A2OR122 | 315-0474-00 | | | RES,FXD,FILM:470K OHM,5%,0.25W | 19701 | 5043CX470KQJ92U |
| A2OR124 | 315-0331-03 | | | RES,FXD,CMPSN:330 OHM 5%,0.25W | 01121 | CB3315 |
| A2OR126 | 315-0681-00 | | | RES,FXD,FILM:680 OHM,5%,0.25W | 57668 | NTR25J-E680E |
| A2OR127 | 315-0332-00 | | | RES,FXD,FILM:3.3K OHM,5%,0.25W | 57668 | NTR25J-E03K3 |
| A2OR128 | 301-0623-02 | | | RES,FXD,CMPSN:62K OHM,5%,0.5W | 01121 | EB6235 |
| A2OR129 | 315-0150-00 | | | RES,FXD,FILM:15 OHM,5%,0.25W | 19701 | 5043CX15R00J |
| A2OR143 | 311-1287-00 | | | RES,VAR,NONNW:TRMR,100K OHM,0.5W | 32997 | 3329S-L58-104 |
| A2OR154 | 321-0271-00 | | | RES,FXD,FILM:6.49K OHM,1%,0.125W,TC=TO | 07716 | CEAD64900F |
| A2OR155 | 311-1282-00 | | | RES,VAR,NONNW:TRMR,5K OHM,0.5W | 32997 | 3329S-L58-502 |
| A2OR156 | 321-0310-00 | | | RES,FXD,FILM:16.5K OHM,1%,0.125W,TC=TO | 19701 | 5033ED16K50F |
| A2OT14 | 120-1281-00 | | | XFMR,PWR,SON&SU:HIGH VOLTAGE | 75498 | 120-1281-00 |
| A2OTP78 | 214-0579-00 | | | TERM,TEST POINT:BRS CD PL | 80009 | 214-0579-00 |
| A2OTP79 | 214-0579-00 | | | TERM,TEST POINT:BRS CD PL | 80009 | 214-0579-00 |
| A2OTP113 | 214-0579-00 | | | TERM,TEST POINT:BRS CD PL | 80009 | 214-0579-00 |
| A2OTP127 | 214-0579-00 | | | TERM,TEST POINT:BRS CD PL | 80009 | 214-0579-00 |
| A2OTP156 | 214-0579-00 | | | TERM,TEST POINT:BRS CD PL | 80009 | 214-0579-00 |
| A2OU21 | 152-0716-00 | | | SEMICONDC DVC,DI:HV MULTR,SI,3KV PP IN,21KV DC OUT | 60211 | VM164 |
| A2OU123 | 156-0067-12 | B010100 | B010784 | MICROCKT,LINEAR:OPERATIONAL AMPLIFIER | 01295 | UA741CJG |
| A2OU123 | 156-0067-01 | B010785 | B041970 | MICROCKT,LINEAR:OPNL AMPL,CHECKED | 04713 | MC1741CP1DS |
| A2OU123 | 156-0067-00 | B041971 | | MICROCKT,LINEAR:BIPOLAR,OPNL AMPL | 04713 | MC1741CP1 |
| A2OVR51 | 152-0247-00 | | | SEMICONDC DVC,DI:ZEN,SI,150V,5%,0.4W,DO-7 | 04713 | SZG275K1RL |
| A21 | 670-5834-20 | B010100 | B021636 | CIRCUIT BD ASSY:Z AXIS | 80009 | 670-5834-20 |
| A21 | 670-5834-21 | B021637 | | CIRCUIT BD ASSY:Z AXIS | 80009 | 670-5834-21 |
| A21C2 | 283-0003-00 | | | CAP,FXD,CER DI:0.01UF,+80-20%,150V | 59821 | D103Z40Z5UJDCX |
| A21C3 | 281-0773-00 | | | CAP,FXD,CER DI:0.01UF,10%,100V | 04222 | MA201C103KAA |

| Component No. | Tektronix Part No. | Serial/Assembly No. Effective | Discont | Name & Description | Mfr. Code | Mfr. Part No. |
|---------------|--------------------|-------------------------------|---------|---|-----------|------------------|
| A21C4 | 290-0539-00 | | | CAP, FXD, ELCTLT:47UF, 20%, 20V | 05397 | T110C476M020AS |
| A21C6 | 281-0773-00 | | | CAP, FXD, CER DI:0.01UF, 10%, 100V | 04222 | MA201C103KAA |
| A21C7 | 281-0773-00 | | | CAP, FXD, CER DI:0.01UF, 10%, 100V | 04222 | MA201C103KAA |
| A21C8 | 283-0177-00 | | | CAP, FXD, CER DI:1UF, +80-20%, 25V | 04222 | SR305E105ZAA |
| A21C9 | 283-0059-00 | | | CAP, FXD, CER DI:1UF, +80-20%, 50V | 04222 | SR305C105MAA |
| A21C10 | 281-0773-00 | | | CAP, FXD, CER DI:0.01UF, 10%, 100V | 04222 | MA201C103KAA |
| A21C11 | 290-0539-00 | | | CAP, FXD, ELCTLT:47UF, 20%, 20V | 05397 | T110C476M020AS |
| A21C12 | 281-0773-00 | | | CAP, FXD, CER DI:0.01UF, 10%, 100V | 04222 | MA201C103KAA |
| A21C13 | 281-0773-00 | | | CAP, FXD, CER DI:0.01UF, 10%, 100V | 04222 | MA201C103KAA |
| A21C76 | 283-0001-00 | | | CAP, FXD, CER DI:0.005UF, +100-0%, 500V | 59821 | 2DDH61L502P |
| A21C79 | 283-0001-00 | | | CAP, FXD, CER DI:0.005UF, +100-0%, 500V | 59821 | 2DDH61L502P |
| A21C83 | 281-0773-00 | | | CAP, FXD, CER DI:0.01UF, 10%, 100V | 04222 | MA201C103KAA |
| A21C101 | 281-0611-00 | | | CAP, FXD, CER DI:2.7PF, +/-0.25PF, 200V | 52763 | 2RDPLZ007 2P70CC |
| A21C113 | 281-0773-00 | | | CAP, FXD, CER DI:0.01UF, 10%, 100V | 04222 | MA201C103KAA |
| A21C123 | 281-0773-00 | | | CAP, FXD, CER DI:0.01UF, 10%, 100V | 04222 | MA201C103KAA |
| A21C150 | 281-0118-00 | B010100 | B021636 | CAP, VAR, MICA DI:8-90PF, 175V | 52769 | GSM231 |
| A21C150 | 281-0253-00 | B021637 | | CAP, VAR, PLASTIC:10-180PF, 100V | 52769 | GZC 18100 |
| A21C151 | 281-0550-00 | B010100 | B021636 | CAP, FXD, CER DI:120PF, 10%, 500V | 52763 | 2RDPLZ007 120PMO |
| A21C151 | 281-0765-00 | B021637 | | CAP, FXD, CER DI:100PF, 5%, 100V | 04222 | MA101A101JAA |
| A21C155 | 281-0118-00 | B010100 | B021636 | CAP, VAR, MICA DI:8-90PF, 175V | 52769 | GSM231 |
| A21C155 | 281-0253-00 | B021637 | | CAP, VAR, PLASTIC:10-180PF, 100V | 52769 | GZC 18100 |
| A21C156 | 281-0584-00 | B010100 | B021636 | CAP, FXD, CER DI:100PF, 5%, 500V | 72982 | 0301000 Y5E0101J |
| A21C156 | 281-0798-00 | B021637 | | CAP, FXD, CER DI:51PF, 1%, 100V | 04222 | MA101A510GAA |
| A21C169 | 283-0211-00 | | | CAP, FXD, CER DI:0.1UF, 10%, 200V | 04222 | SR406C104KAA |
| A21C171 | 290-0149-00 | | | CAP, FXD, ELCTLT:5UF, +75-10%, 150V | 00853 | 556DD050U150B |
| A21C172 | 283-0770-00 | | | CAP, FXD, MICA DI:300 PF, 1%, 500V | 00853 | D155F301F0 |
| A21C179 | 281-0619-00 | | | CAP, FXD, CER DI:1.2PF, +/-0.1PF, 500V | 52763 | 2RDPLZ007 1P20BC |
| A21C180 | 281-0092-00 | | | CAP, VAR, CER DI:9-35PF, 200V | 33095 | 53-717-001 D9-35 |
| A21C183 | 281-0773-00 | | | CAP, FXD, CER DI:0.01UF, 10%, 100V | 04222 | MA201C103KAA |
| A21C186 | 281-0609-00 | | | CAP, FXD, CER DI:1PF, +/-0.1PF, 500V | 52763 | 2RDPLZ007 1P00BC |
| A21CR32 | 152-0141-02 | | | SEMICON DVC, DI:SW, SI, 30V, 150MA, 30V, DO-35 | 03508 | DA2527 (1N4152) |
| A21CR35 | 152-0141-02 | | | SEMICON DVC, DI:SW, SI, 30V, 150MA, 30V, DO-35 | 03508 | DA2527 (1N4152) |
| A21CR36 | 152-0141-02 | | | SEMICON DVC, DI:SW, SI, 30V, 150MA, 30V, DO-35 | 03508 | DA2527 (1N4152) |
| A21CR37 | 152-0141-02 | | | SEMICON DVC, DI:SW, SI, 30V, 150MA, 30V, DO-35 | 03508 | DA2527 (1N4152) |
| A21CR39 | 152-0141-02 | | | SEMICON DVC, DI:SW, SI, 30V, 150MA, 30V, DO-35 | 03508 | DA2527 (1N4152) |
| A21CR43 | 152-0141-02 | | | SEMICON DVC, DI:SW, SI, 30V, 150MA, 30V, DO-35 | 03508 | DA2527 (1N4152) |
| A21CR64 | 152-0141-02 | | | SEMICON DVC, DI:SW, SI, 30V, 150MA, 30V, DO-35 | 03508 | DA2527 (1N4152) |
| A21CR65 | 152-0141-02 | | | SEMICON DVC, DI:SW, SI, 30V, 150MA, 30V, DO-35 | 03508 | DA2527 (1N4152) |
| A21CR76 | 152-0141-02 | | | SEMICON DVC, DI:SW, SI, 30V, 150MA, 30V, DO-35 | 03508 | DA2527 (1N4152) |
| A21CR82 | 152-0141-02 | | | SEMICON DVC, DI:SW, SI, 30V, 150MA, 30V, DO-35 | 03508 | DA2527 (1N4152) |
| A21CR86 | 152-0066-03 | | | SEMICON DVC, DI:RECT, SI, 400V, 1A, DO-41 | 14433 | LG4017 |
| A21CR127 | 152-0141-02 | | | SEMICON DVC, DI:SW, SI, 30V, 150MA, 30V, DO-35 | 03508 | DA2527 (1N4152) |
| A21CR143 | 152-0071-00 | B010100 | B021636 | SEMICON DVC, DI:SW, GE, 15V, 40MA, DO-7 | 15238 | G865 |
| A21CR143 | 152-0725-00 | B021637 | | SEMICON DVC, DI:SI, SCHOTTKY, 20V, 1.2PF, DO-35 | 21847 | A2X1582 |
| A21CR152 | 152-0141-02 | | | SEMICON DVC, DI:SW, SI, 30V, 150MA, 30V, DO-35 | 03508 | DA2527 (1N4152) |
| A21CR153 | 152-0141-02 | | | SEMICON DVC, DI:SW, SI, 30V, 150MA, 30V, DO-35 | 03508 | DA2527 (1N4152) |
| A21CR173 | 152-0141-02 | | | SEMICON DVC, DI:SW, SI, 30V, 150MA, 30V, DO-35 | 03508 | DA2527 (1N4152) |
| A21CR177 | 152-0233-00 | | | SEMICON DVC, DI:SW, SI, 80V, 75MA, DO-7 | 03508 | DA2737 |
| A21CR184 | 152-0141-02 | | | SEMICON DVC, DI:SW, SI, 30V, 150MA, 30V, DO-35 | 03508 | DA2527 (1N4152) |
| A21J37 | 131-1003-00 | | | CONN, RCPT, ELEC:CKT BD MT, 3 PRONG | 80009 | 131-1003-00 |
| A21J78 | 131-1003-00 | | | CONN, RCPT, ELEC:CKT BD MT, 3 PRONG | 80009 | 131-1003-00 |
| A21J110 | 131-1003-00 | | | CONN, RCPT, ELEC:CKT BD MT, 3 PRONG | 80009 | 131-1003-00 |
| A21P20 | 131-0608-00 | | | TERMINAL, PIN:0.365 L X 0.025 BRZ GLD PL (QUANTITY OF 10) | 22526 | 48283-036 |
| A21P57 | 131-0608-00 | | | TERMINAL, PIN:0.365 L X 0.025 BRZ GLD PL (QUANTITY OF 7) | 22526 | 48283-036 |
| A21P65 | 131-0608-00 | | | TERMINAL, PIN:0.365 L X 0.025 BRZ GLD PL (QUANTITY OF 5) | 22526 | 48283-036 |
| A21P83 | 131-0608-00 | B010100 | B010229 | TERMINAL, PIN:0.365 L X 0.025 BRZ GLD PL | 22526 | 48283-036 |

Replaceable Electrical Parts - 7904A

| Component No. | Tektronix Part No. | Serial/Assembly No. Effective | Discont | Name & Description | Mfr. Code | Mfr. Part No. |
|---------------|--------------------|-------------------------------|---------|--|-----------|-----------------|
| A21P83 | 131-0589-00 | 8010230 | | (QUANTITY OF 2) TERMINAL,PIN:0.46 L X 0.025 SQ PH BRZ | 22526 | 48283-029 |
| A21P132 | 131-0608-00 | | | (QUANTITY OF 2) TERMINAL,PIN:0.365 L X 0.025 BRZ GLD PL | 22526 | 48283-036 |
| A21Q32 | 151-0190-05 | | | (QUANTITY OF 10) TRANSISTOR:SELECTED 2N3904 | 80009 | 151-0190-05 |
| A21Q36 | 151-0223-03 | | | TRANSISTOR:NPN,SI,TO-92 | 80009 | 151-0223-03 |
| A21Q39 | 151-0190-05 | | | TRANSISTOR:SELECTED 2N3904 | 80009 | 151-0190-05 |
| A21Q46 | 151-0223-03 | | | TRANSISTOR:NPN,SI,TO-92 | 80009 | 151-0223-03 |
| A21Q50 | 151-0190-05 | | | TRANSISTOR:SELECTED 2N3904 | 80009 | 151-0190-05 |
| A21Q67 | 151-0220-05 | | | TRANSISTOR:SCREENED | 80009 | 151-0220-05 |
| A21Q68 | 151-0220-05 | | | TRANSISTOR:SCREENED | 80009 | 151-0220-05 |
| A21Q77 | 151-0443-02 | | | TRANSISTOR:SELECTED | 80009 | 151-0443-02 |
| A21Q83 | 151-0444-01 | 8010100 | 8010140 | TRANSISTOR:NPN,SI,SEL | 80009 | 151-0444-01 |
| A21Q83 | 151-0444-03 | 8010141 | | TRANSISTOR:NPN,SI,TO-92,SCREENED | TK0271 | 151-0444-00 |
| A21Q113 | 151-0220-05 | | | TRANSISTOR:SCREENED | 80009 | 151-0220-05 |
| A21Q122 | 151-0220-05 | | | TRANSISTOR:SCREENED | 80009 | 151-0220-05 |
| A21Q127 | 151-0427-00 | | | TRANSISTOR:NPN,SI,TO-92 | 07263 | S39287 |
| A21Q132 | 151-0220-05 | | | TRANSISTOR:SCREENED | 80009 | 151-0220-05 |
| A21Q143 | 151-0220-05 | | | TRANSISTOR:SCREENED | 80009 | 151-0220-05 |
| A21Q162 | 151-0220-05 | | | TRANSISTOR:SCREENED | 80009 | 151-0220-05 |
| A21Q166 | 151-0434-01 | | | TRANSISTOR:SELECTED | 04713 | SS7144H |
| A21Q167 | 151-0434-01 | | | TRANSISTOR:SELECTED | 04713 | SS7144H |
| A21Q173 | 151-0270-03 | | | TRANSISTOR:SCREENED | 04713 | ST919H |
| A21Q183 | 151-0274-01 | | | TRANSISTOR:SCREENED | 04713 | SS7394H |
| A21Q184 | 151-0192-03 | | | TRANSISTOR:SELECTED | 80009 | 151-0192-03 |
| A21R4 | 307-0106-00 | | | RES,FXD,CMPSN:4.7 OHM,5%,0.25W | 01121 | CB 47G5 |
| A21R8 | 315-0100-00 | | | RES,FXD,FILM:10 OHM,5%,0.25W | 19701 | 5043CX10RROOJ |
| A21R9 | 307-0107-00 | | | RES,FXD,CMPSN:5.6 OHM,5%,0.25W | 01121 | CB56G5 |
| A21R11 | 307-0106-00 | | | RES,FXD,CMPSN:4.7 OHM,5%,0.25W | 01121 | CB 47G5 |
| A21R12 | 315-0100-00 | | | RES,FXD,FILM:10 OHM,5%,0.25W | 19701 | 5043CX10RROOJ |
| A21R31 | 321-0289-00 | | | RES,FXD,FILM:10.0K OHM,1%,0.125W,TC=TO | 19701 | 5033ED10K0F |
| A21R35 | 315-0221-00 | | | RES,FXD,FILM:220 OHM,5%,0.25W | 57668 | NTR25J-E220E |
| A21R36 | 315-0102-00 | | | RES,FXD,FILM:1K OHM,5%,0.25W | 57668 | NTR25JE01K0 |
| A21R37 | 321-0289-00 | | | RES,FXD,FILM:10.0K OHM,1%,0.125W,TC=TO | 19701 | 5033ED10K0F |
| A21R43 | 321-0333-00 | | | RES,FXD,FILM:28.7K OHM,1%,0.125W,TC=TO | 19701 | 5043ED28K70F |
| A21R61 | 321-0341-00 | | | RES,FXD,FILM:34.8K OHM,1%,0.125W,TC=TO | 19701 | 5043ED34K80F |
| A21R62 | 321-0193-00 | | | RES,FXD,FILM:1K OHM,1%,0.125W,TC=TO | 19701 | 5033ED1K00F |
| A21R63 | 311-1757-00 | | | RES,VAR,NONNW:2.5K OHM 10%,.5W LIN,CERMET | 73138 | 82PR2.5K-124C |
| A21R64 | 315-0471-00 | | | RES,FXD,FILM:470 OHM,5%,0.25W | 57668 | NTR25J-E470E |
| A21R65 | 321-0254-00 | | | RES,FXD,FILM:4.32K OHM,1%,0.125W,TC=TO | 07716 | CEAD43200F |
| A21R67 | 315-0102-00 | | | RES,FXD,FILM:1K OHM,5%,0.25W | 57668 | NTR25JE01K0 |
| A21R70 | 311-1267-00 | | | RES,VAR,NONNW:TRMR,5K OHM,0.5W | 32997 | 3329P-L58-502 |
| A21R71 | 321-0334-00 | B010100 | B021636 | RES,FXD,FILM:29.4K OHM,1%,0.125W,TC=TO | 07716 | CEAD29401F |
| A21R71 | 321-0336-00 | B021637 | | RES,FXD,FILM:30.9K OHM,1%,0.125W,TC=TO | 19701 | 5043ED30K90F |
| A21R72 | 321-0231-00 | | | RES,FXD,FILM:2.49K OHM,1%,0.125W,TC=TO | 19701 | 5033ED2K49F |
| A21R73 | 321-0410-00 | | | RES,FXD,FILM:182K OHM,1%,0.125W,TC=TO | 19701 | 5033ED182K0F |
| A21R75 | 315-0753-00 | | | RES,FXD,FILM:75K OHM,5%,0.25W | 57668 | NTR25J-E75K0 |
| A21R76 | 321-0260-00 | | | RES,FXD,FILM:4.99K OHM,1%,0.125W,TC=TO | 19701 | 5033ED4K990F |
| A21R77 | 315-0132-00 | | | RES,FXD,FILM:1.3K OHM,5%,0.25W | 57668 | NTR25J-E01K3 |
| A21R79 | 315-0473-00 | | | RES,FXD,FILM:47K OHM,5%,0.25W | 57668 | NTR25J-E47K0 |
| A21R81 | 315-0103-00 | | | RES,FXD,FILM:10K OHM,5%,0.25W | 19701 | 5043CX10K00J |
| A21R82 | 315-0391-00 | | | RES,FXD,FILM:390 OHM,5%,0.25W | 57668 | NTR25J-E390E |
| A21R83 | 315-0101-00 | | | RES,FXD,FILM:100 OHM,5%,0.25W | 57668 | NTR25J-E 100E |
| A21R101 | 317-0100-00 | | | RES,FXD,CMPSN:10 OHM,5%,0.125W | 01121 | BB1005 |
| A21R109 | 321-0126-00 | | | RES,FXD,FILM:200 OHM,1%,0.125W,TC=TO | 19701 | 5033ED200ROF |
| A21R110 | 321-0066-00 | | | RES,FXD,FILM:47.5 OHM,0.5%,0.125W,TC=TO | 91637 | CMF55116G47R50F |
| A21R111 | 321-0193-00 | | | RES,FXD,FILM:1K OHM,1%,0.125W,TC=TO | 19701 | 5033ED1K00F |

| Component No. | Tektronix Part No. | Serial/Assembly No. Effective | Discont | Name & Description | Mfr. Code | Mfr. Part No. |
|---------------|--------------------|-------------------------------|---------|--|-----------|------------------|
| A21R113 | 315-0101-00 | | | RES,FXD,FILM:100 OHM,5%,0.25W | 57668 | NTR25J-E 100E |
| A21R121 | 321-0126-00 | | | RES,FXD,FILM:200 OHM,1%,0.125W,TC=TO | 19701 | 5033ED200ROF |
| A21R122 | 321-0206-00 | | | RES,FXD,FILM:1.37K OHM,1%,0.125W,TC=TO | 07716 | CEAD13700F |
| A21R123 | 315-0272-00 | | | RES,FXD,FILM:2.7K OHM,5%,0.25W | 57668 | NTR25J-E02K7 |
| A21R124 | 323-0275-00 | | | RES,FXD,FILM:7.15K OHM,1%,0.5W,TC=TO | 75042 | CECT0-7151F |
| A21R125 | 311-1263-00 | | | RES,VAR,NONW:1K OHM,10%,0.50W | 32997 | 3329P-L58-102 |
| A21R126 | 321-0126-00 | | | RES,FXD,FILM:200 OHM,1%,0.125W,TC=TO | 19701 | 5033ED200ROF |
| A21R127 | 315-0102-00 | | | RES,FXD,FILM:1K OHM,5%,0.25W | 57668 | NTR25JE01K0 |
| A21R128 | 315-0200-00 | | | RES,FXD,FILM:20 OHM,5%,0.25W | 19701 | 5043CX20R00J |
| A21R129 | 321-0126-00 | | | RES,FXD,FILM:200 OHM,1%,0.125W,TC=TO | 19701 | 5033ED200ROF |
| A21R132 | 321-0206-00 | | | RES,FXD,FILM:1.37K OHM,1%,0.125W,TC=TO | 07716 | CEAD13700F |
| A21R133 | 315-0101-00 | | | RES,FXD,FILM:100 OHM,5%,0.25W | 57668 | NTR25J-E 100E |
| A21R134 | 315-0561-00 | | | RES,FXD,FILM:560 OHM,5%,0.25W | 19701 | 5043CX560R0J |
| A21R135 | 311-1260-00 | | | RES,VAR,NONW:TRMR,250 OHM,0.5W | 32997 | 3329P-L58-251 |
| A21R136 | 315-0271-00 | | | RES,FXD,FILM:270 OHM,5%,0.25W | 57668 | NTR25J-E270E |
| A21R143 | 315-0152-00 | | | RES,FXD,FILM:1.5K OHM,5%,0.25W | 57668 | NTR25J-E01K5 |
| A21R150 | 311-0622-00 | | | RES,VAR,NONW:TRMR,100 OHM,0.5W | 32997 | 3329H-L58-101 |
| A21R155 | 311-0622-00 | | | RES,VAR,NONW:TRMR,100 OHM,0.5W | 32997 | 3329H-L58-101 |
| A21R156 | 315-0105-00 | | | RES,FXD,FILM:1M OHM,5%,0.25W | 19701 | 5043CX1M000J |
| A21R161 | 315-0101-00 | | | RES,FXD,FILM:100 OHM,5%,0.25W | 57668 | NTR25J-E 100E |
| A21R162 | 315-0681-00 | | | RES,FXD,FILM:680 OHM,5%,0.25W | 57668 | NTR25J-E680E |
| A21R166 | 315-0391-00 | | | RES,FXD,FILM:390 OHM,5%,0.25W | 57668 | NTR25J-E390E |
| A21R167 | 315-0361-00 | | | RES,FXD,FILM:360 OHM,5%,0.25W | 19701 | 5043CX360R0J |
| A21R168 | 315-0302-00 | | | RES,FXD,FILM:3K OHM,5%,0.25W | 57668 | NTR25J-E03K0 |
| A21R169 | 303-0432-00 | | | RES,FXD,CMPSN:4.3K OHM,5%,1W | 01121 | GB4325 |
| A21R171 | 321-0347-00 | | | RES,FXD,FILM:40.2K OHM,1%,0.125W,TC=TO | 91637 | CMF55116640201F |
| A21R172 | 321-0369-00 | | | RES,FXD,FILM:68.1K OHM,1%,0.125W,TC=TO | 19701 | 5043ED68K10F |
| A21R173 | 315-0510-00 | | | RES,FXD,FILM:51 OHM,5%,0.25W | 19701 | 5043CX51R00J |
| A21R176 | 301-0472-00 | | | RES,FXD,FILM:4.7K OHM,5%,0.5W | 19701 | 5053CX4K700J |
| A21R177 | 301-0472-00 | | | RES,FXD,FILM:4.7K OHM,5%,0.5W | 19701 | 5053CX4K700J |
| A21R179 | 323-0356-00 | | | RES,FXD,FILM:49.9K OHM,1%,0.5W,TC=TO | 75042 | CECT0-4992F |
| A21R180 | 321-0260-00 | | | RES,FXD,FILM:4.99K OHM,1%,0.125W,TC=TO | 19701 | 5033ED4K990F |
| A21R183 | 321-0097-00 | | | RES,FXD,FILM:100 OHM,1%,0.125W,TC=TO | 91637 | CMF551166100ROF |
| A21TP32 | 214-0579-00 | B010100 | B021636 | TERM,TEST POINT:BRS CD PL | 80009 | 214-0579-00 |
| A21TP83 | 214-0579-00 | 8010100 | B021636 | TERM,TEST POINT:BRS CD PL | 80009 | 214-0579-00 |
| A21TP122 | 214-0579-00 | 8010100 | B021636 | TERM,TEST POINT:BRS CD PL | 80009 | 214-0579-00 |
| A21TP143 | 214-0579-00 | B010100 | B021636 | TERM,TEST POINT:BRS CD PL | 80009 | 214-0579-00 |
| A21TP183 | 214-0579-00 | B010100 | 8021636 | TERM,TEST POINT:BRS CD PL | 80009 | 214-0579-00 |
| A21TP186 | 214-0579-00 | 8010100 | 8021636 | TERM,TEST POINT:BRS CD PL | 80009 | 214-0579-00 |
| A21TP186 | 131-1436-00 | B021637 | | RCPT,COAX CA:CKT 8D MT,3-PRONG,BRS GOLD PL | 80009 | 131-1436-00 |
| A21TP186 | 136-0333-00 | 8021637 | | SOCKET,PIN TERM:U/W 0.03 DIA PINS | 00779 | 1-331677-4 |
| A22 | 670-5960-03 | 8010100 | 8031870 | CIRCUIT BD ASSY:LOW VOLTAGE REGULATOR | 80009 | 670-5960-03 |
| A22 | 670-5960-04 | B031871 | | CIRCUIT BD ASSY:LV REGULATOR | 80009 | 670-5960-04 |
| A22C8 | 290-0778-00 | | | CAP,FXD,ELCTLT:1UF,20%,50V,NPLZD | 54473 | ECE-A50N1 |
| A22C12 | 290-0778-00 | | | CAP,FXD,ELCTLT:1UF,20%,50V,NPLZD | 54473 | ECE-A50N1 |
| A22C13 | 283-0047-00 | | | CAP,FXD,CER DI:270PF,5%,500V | 59660 | 0831604Z5F0271J |
| A22C15 | 281-0629-00 | | | CAP,FXD,CER DI:33PF,5%,600V | 52763 | 2RDPLZ007 33PQJC |
| A22C17 | 290-0778-00 | | | CAP,FXD,ELCTLT:1UF,20%,50V,NPLZD | 54473 | ECE-A50N1 |
| A22C24 | 283-0110-00 | | | CAP,FXD,CER DI:0.005UF,+80-20%,150V | 59660 | 855-547-E-502Z |
| A22C36 | 281-0775-00 | | | CAP,FXD,CER DI:0.1UF,20%,50V | 04222 | MA205E104MAA |
| A22C44 | 283-0067-00 | | | CAP,FXD,CER DI:0.001UF,10%,200V | 59660 | 835-515-YSE0102K |
| A22C45 | 281-0511-00 | | | CAP,FXD,CER DI:22PF,+/-2.2PF,500V | 52763 | 2RDPLZ007 22POK |
| A22C47 | 290-0778-00 | | | CAP,FXD,ELCTLT:1UF,20%,50V,NPLZD | 54473 | ECE-A50N1 |
| A22C54 | 283-0100-00 | | | CAP,FXD,CER DI:0.0047UF,10%,200V | 04222 | SR306A472KAA |
| A22C64 | 281-0540-00 | | | CAP,FXD,CER DI:51PF,5%,500V | 59660 | 301-000U2J0510J |
| A22C68 | 290-0420-00 | | | CAP,FXD,ELCTLT:0.68UF,20%,75V | 05397 | T110A684M075AS |
| A22C69 | 283-0067-00 | | | CAP,FXD,CER DI:0.001UF,10%,200V | 59660 | 835-515-YSE0102K |
| A22C84 | 281-0629-00 | | | CAP,FXD,CER DI:33PF,5%,600V | 52763 | 2RDPLZ007 33PQJC |

Replaceable Electrical Parts - 7904A

| Component No. | Tektronix Part No. | Serial/Assembly No. Effective Dscont | Name & Description | Mfr. Code | Mfr. Part No. |
|---------------|--------------------|--------------------------------------|--|-----------|-----------------|
| A22C88 | 290-0420-00 | | CAP,FXD,ELCLTL:0.68UF,20%,75V | 05397 | T110A684M075AS |
| A22C114 | 281-0605-00 | | CAP,FXD,CER DI:200PF,10%,500V | 59660 | 301000Y5D201K |
| A22C156 | 290-0745-00 | | CAP,FXD,ELCLTL:22UF,+50-20%,25WVDC | 54473 | ECE-A25V22L |
| A22CR7 | 152-0333-00 | | SEMICON DVC,DI:SW,S1,55V,200MA,DO-35 | 07263 | FDH-6012 |
| A22CR8 | 152-0333-00 | | SEMICON DVC,DI:SW,S1,55V,200MA,DO-35 | 07263 | FDH-6012 |
| A22CR10 | 152-0333-00 | | SEMICON DVC,DI:SW,S1,55V,200MA,DO-35 | 07263 | FDH-6012 |
| A22CR11 | 152-0333-00 | | SEMICON DVC,DI:SW,S1,55V,200MA,DO-35 | 07263 | FDH-6012 |
| A22CR15 | 152-0333-00 | | SEMICON DVC,DI:SW,S1,55V,200MA,DO-35 | 07263 | FDH-6012 |
| A22CR19 | 152-0141-02 | | SEMICON DVC,DI:SW,S1,30V,150MA,30V,DO-35 | 03508 | DA2527 (1N4152) |
| A22CR20 | 152-0141-02 | | SEMICON DVC,DI:SW,S1,30V,150MA,30V,DO-35 | 03508 | DA2527 (1N4152) |
| A22CR21 | 152-0141-02 | | SEMICON DVC,DI:SW,S1,30V,150MA,30V,DO-35 | 03508 | DA2527 (1N4152) |
| A22CR22 | 152-0333-00 | | SEMICON DVC,DI:SW,S1,55V,200MA,DO-35 | 07263 | FDH-6012 |
| A22CR28 | 152-0066-03 | | SEMICON DVC,DI:RECT,S1,400V,1A,DO-41 | 14433 | LG4017 |
| A22CR45 | 152-0333-00 | | SEMICON DVC,DI:SW,S1,55V,200MA,DO-35 | 07263 | FDH-6012 |
| A22CR49 | 152-0141-02 | | SEMICON DVC,DI:SW,S1,30V,150MA,30V,DO-35 | 03508 | DA2527 (1N4152) |
| A22CR50 | 152-0141-02 | | SEMICON DVC,DI:SW,S1,30V,150MA,30V,DO-35 | 03508 | DA2527 (1N4152) |
| A22CR51 | 152-0141-02 | | SEMICON DVC,DI:SW,S1,30V,150MA,30V,DO-35 | 03508 | DA2527 (1N4152) |
| A22CR52 | 152-0333-00 | | SEMICON DVC,DI:SW,S1,55V,200MA,DO-35 | 07263 | FDH-6012 |
| A22CR58 | 152-0066-03 | | SEMICON DVC,DI:RECT,S1,400V,1A,DO-41 | 14433 | LG4017 |
| A22CR64 | 152-0333-00 | | SEMICON DVC,DI:SW,S1,55V,200MA,DO-35 | 07263 | FDH-6012 |
| A22CR76 | 152-0066-03 | | SEMICON DVC,DI:RECT,S1,400V,1A,DO-41 | 14433 | LG4017 |
| A22CR84 | 152-0333-00 | | SEMICON DVC,DI:SW,S1,55V,200MA,DO-35 | 07263 | FDH-6012 |
| A22CR96 | 152-0066-03 | | SEMICON DVC,DI:RECT,S1,400V,1A,DO-41 | 14433 | LG4017 |
| A22CR114 | 152-0333-00 | | SEMICON DVC,DI:SW,S1,55V,200MA,DO-35 | 07263 | FDH-6012 |
| A22CR132 | 152-0066-03 | | SEMICON DVC,DI:RECT,S1,400V,1A,DO-41 | 14433 | LG4017 |
| A22CR142 | 152-0423-00 | | SEMICON DVC,DI:RECT,S1,400V,3A,M176A | 04713 | 1N5000 |
| A22CR143 | 152-0141-02 | | SEMICON DVC,DI:SW,S1,30V,150MA,30V,DO-35 | 03508 | DA2527 (1N4152) |
| A22CR144 | 152-0423-00 | | SEMICON DVC,DI:RECT,S1,400V,3A,M176A | 04713 | 1N5000 |
| A22CR148 | 152-0141-02 | | SEMICON DVC,DI:SW,S1,30V,150MA,30V,DO-35 | 03508 | DA2527 (1N4152) |
| A22P82 | 131-0589-00 | | TERMINAL,PIN:0.46 L X 0.025 SQ PH BRZ (QUANTITY OF 10) | 22526 | 48283-029 |
| A22P83 | 131-0589-00 | | TERMINAL,PIN:0.46 L X 0.025 SQ PH BRZ (QUANTITY OF 8) | 22526 | 48283-029 |
| A22P90 | 131-0608-00 | | TERMINAL,PIN:0.365 L X 0.025 BRZ GLD PL (QUANTITY OF 2) | 22526 | 48283-036 |
| A22Q22 | 151-0350-00 | | TRANSISTOR:PNP,SI,TO-92 | 04713 | SPS6700 |
| A22Q34 | 151-0103-00 | | TRANSISTOR:NPN,SI,TO-5 | 80009 | 151-0103-00 |
| A22Q38 | 151-0134-00 | | TRANSISTOR:PNP,SI,TO-39 | 04713 | SM3195 |
| A22Q52 | 151-0347-00 | | TRANSISTOR:NPN,SI,TO-92 | 04713 | SPS7951 |
| A22Q68 | 151-0347-00 | | TRANSISTOR:NPN,SI,TO-92 | 04713 | SPS7951 |
| A22Q88 | 151-0342-00 | | TRANSISTOR:PNP,SI,TO-92 | 07263 | S035928 |
| A22Q118 | 151-0302-00 | | TRANSISTOR:NPN,SI,TO-18 | 04713 | ST899 |
| A22Q144 | 151-0190-05 | | TRANSISTOR:SELECTED 2N3904 | 80009 | 151-0190-05 |
| A22Q148 | 151-0373-00 | | TRANSISTOR:PNP,SI,TD-127 | 04713 | SJE925 |
| A22R1 | 321-0369-00 | | RES,FXD,FILM:68.1K OHM,1%,0.125W,TC=TO | 19701 | 5043ED68K10F |
| A22R2 | 321-0386-00 | | RES,FXD,FILM:102K OHM,1%,0.125W,TC=TO | 07716 | CEA010202F |
| A22R3 | 321-0336-00 | | RES,FXD,FILM:30.9K OHM,1%,0.125W,TC=TO | 19701 | 5043ED30K90F |
| A22R4 | 321-0290-00 | | RES,FXD,FILM:10.2K OHM,1%,0.125W,TC=TO | 19701 | 5043ED10K20F |
| A22R5 | 321-0319-00 | | RES,FXD,FILM:20.5K OHM,1%,0.125W,TC=TO | 19701 | 5033ED20K50F |
| A22R8 | 315-0332-00 | | RES,FXD,FILM:3.3K OHM,5%,0.25W | 57668 | NTR25J-E03K3 |
| A22R10 | 323-0265-00 | | RES,FXD,FILM:5.62K OHM,1%,0.5W,TC=TO | 75042 | CECT0-5621F |
| A22R12 | 315-0512-00 | | RES,FXD,FILM:5.1K OHM,5%,0.25W | 57668 | NTR25J-E05K1 |
| A22R13 | 315-0103-00 | | RES,FXD,FILM:10K OHM,5%,0.25W | 19701 | 5043CX10K00J |
| A22R14 | 321-0730-06 | | RES,FXD,FILM:5.703K OHM,0.2%,0.125W,TC=T9 | 19701 | 5033RE5K703C |
| A22R15 | 311-1225-00 | | RES,VAR,NONWV:TRMR,1K OHM,0.5W | 32997 | 3386F-T04-102 |
| A22R16 | 321-0331-09 | | RES,FXD,FILM:27.4K OHM,1%,0.125W,TC=T9 | 19701 | 5033RE27K4F |
| A22R17 | 315-0151-00 | | RES,FXD,FILM:150 OHM,5%,0.25W | 57668 | NTR25J-E150E |
| A22R21 | 315-0104-00 | | RES,FXD,FILM:100K OHM,5%,0.25W | 57668 | NTR25J-E100K |

| Component No. | Tektronix Part No. | Serial/Assembly No. Effective | Discount | Name & Description | Mfr. Code | Mfr. Part No. |
|---------------|--------------------|-------------------------------|----------|--|-----------|-----------------|
| A22R22 | 315-0821-00 | | | RES,FXD,FILM:820 OHM,5%,0.25W | 19701 | 5043CX820R0J |
| A22R24 | 315-0331-00 | | | RES,FXD,FILM:330 OHM,5%,0.25W | 57668 | NTR25J-E330E |
| A22R25 | 315-0471-00 | | | RES,FXD,FILM:470 OHM,5%,0.25W | 57668 | NTR25J-E470E |
| A22R26 | 315-0181-00 | | | RES,FXD,FILM:180 OHM,5%,0.25W | 57668 | NTR25J-E180E |
| A22R27 | 315-0512-00 | | | RES,FXD,FILM:5.1K OHM,5%,0.25W | 57668 | NTR25J-E05K1 |
| A22R28 | 308-0365-00 | | | RES,FXD,WV:1.5 OHM,5%,3W | 00213 | 12405-1.5-5 |
| A22R32 | 315-0432-00 | | | RES,FXD,FILM:4.3K OHM,5%,0.25W | 57668 | NTR25J-E04K3 |
| A22R34 | 304-0102-00 | | | RES,FXD,CMPSN:1K OHM,10%,1W | 01121 | GB1021 |
| A22R36 | 315-0121-00 | | | RES,FXD,FILM:120 OHM,5%,0.25W | 19701 | 5043CX120R0J |
| A22R37 | 315-0123-00 | | | RES,FXD,FILM:12K OHM,5%,0.25W | 57668 | NTR25J-E12K0 |
| A22R38 | 301-0182-00 | | | RES,FXD,FILM:1.8K OHM,5%,0.5W | 19701 | 5053CX1K800J |
| A22R42 | 315-0203-00 | | | RES,FXD,FILM:20K OHM,5%,0.25W | 57668 | NTR25J-E 20K |
| A22R44 | 315-0103-00 | | | RES,FXD,FILM:10K OHM,5%,0.25W | 19701 | 5043CX10K00J |
| A22R45 | 321-0924-07 | | | RES,FXD,FILM:40K OHM,0.1%,0.125W,TC=T9 | 19701 | 5033RE40K00B |
| A22R46 | 321-0924-07 | | | RES,FXD,FILM:40K OHM,0.1%,0.125W,TC=T9 | 19701 | 5033RE40K00B |
| A22R47 | 315-0151-00 | | | RES,FXD,FILM:150 OHM,5%,0.25W | 57668 | NTR25J-E150E |
| A22R51 | 315-0104-00 | | | RES,FXD,FILM:100K OHM,5%,0.25W | 57668 | NTR25J-E100K |
| A22R52 | 315-0821-00 | | | RES,FXD,FILM:820 OHM,5%,0.25W | 19701 | 5043CX820R0J |
| A22R54 | 315-0511-00 | | | RES,FXD,FILM:510 OHM,5%,0.25W | 19701 | 5043CX510R0J |
| A22R55 | 315-0471-00 | | | RES,FXD,FILM:470 OHM,5%,0.25W | 57668 | NTR25J-E470E |
| A22R56 | 315-0181-00 | | | RES,FXD,FILM:180 OHM,5%,0.25W | 57668 | NTR25J-E180E |
| A22R57 | 315-0512-00 | | | RES,FXD,FILM:5.1K OHM,5%,0.25W | 57668 | NTR25J-E05K1 |
| A22R58 | 308-0686-00 | | | RES,FXD,WV:2.2 OHM,5%,2W | 18235 | C-2D 2.2 OHM 5% |
| A22R61 | 321-0332-07 | | | RES,FXD,FILM:28.0K OHM,0.1%,0.125W,TC=T9 | 19701 | 5033RE28K00B |
| A22R62 | 321-1296-07 | | | RES,FXD,FILM:12.0K OHM,0.1%,0.125W,TC=T9 | 19701 | 5033RE12K00B |
| A22R63 | 315-0152-00 | | | RES,FXD,FILM:1.5K OHM,5%,0.25W | 57668 | NTR25J-E01K5 |
| A22R67 | 315-0123-00 | | | RES,FXD,FILM:12K OHM,5%,0.25W | 57668 | NTR25J-E12K0 |
| A22R68 | 315-0302-00 | | | RES,FXD,FILM:3K OHM,5%,0.25W | 57668 | NTR25J-E03K0 |
| A22R69 | 315-0822-00 | | | RES,FXD,FILM:8.2K OHM,5%,0.25W | 19701 | 5043CX8K200J |
| A22R73 | 315-0201-00 | | | RES,FXD,FILM:200 OHM,5%,0.25W | 57668 | NTR25J-E200E |
| A22R74 | 315-0393-00 | | | RES,FXD,FILM:39K OHM,5%,0.25W | 57668 | NTR25J-E39K0 |
| A22R75 | 308-0804-00 | | | RES,FXD,WV:0.025 OHM,5%,0.5W | 80009 | 308-0804-00 |
| A22R76 | 315-0151-00 | | | RES,FXD,FILM:150 OHM,5%,0.25W | 57668 | NTR25J-E150E |
| A22R77 | 315-0432-00 | | | RES,FXD,FILM:4.3K OHM,5%,0.25W | 57668 | NTR25J-E04K3 |
| A22R80 | 321-0924-07 | | | RES,FXD,FILM:40K OHM,0.1%,0.125W,TC=T9 | 19701 | 5033RE40K00B |
| A22R81 | 321-1296-07 | | | RES,FXD,FILM:12.0K OHM,0.1%,0.125W,TC=T9 | 19701 | 5033RE12K00B |
| A22R82 | 315-0912-00 | | | RES,FXD,FILM:9.1K OHM,5%,0.25W | 57668 | NTR25J-E09K1 |
| A22R83 | 315-0102-00 | | | RES,FXD,FILM:1K OHM,5%,0.25W | 57668 | NTR25J-E01K0 |
| A22R87 | 315-0123-00 | | | RES,FXD,FILM:12K OHM,5%,0.25W | 57668 | NTR25J-E12K0 |
| A22R88 | 315-0302-00 | | | RES,FXD,FILM:3K OHM,5%,0.25W | 57668 | NTR25J-E03K0 |
| A22R93 | 315-0201-00 | | | RES,FXD,FILM:200 OHM,5%,0.25W | 57668 | NTR25J-E200E |
| A22R94 | 315-0393-00 | | | RES,FXD,FILM:39K OHM,5%,0.25W | 57668 | NTR25J-E39K0 |
| A22R95 | 308-0804-00 | | | RES,FXD,WV:0.025 OHM,5%,0.5W | 80009 | 308-0804-00 |
| A22R96 | 315-0151-00 | | | RES,FXD,FILM:150 OHM,5%,0.25W | 57668 | NTR25J-E150E |
| A22R97 | 315-0432-00 | | | RES,FXD,FILM:4.3K OHM,5%,0.25W | 57668 | NTR25J-E04K3 |
| A22R113 | 321-1713-07 | | | RES,FXD,FILM:36K OHM,0.1%,0.125W,TC=T9 | 19701 | 5033RE36K00B |
| A22R114 | 321-0926-07 | | | RES,FXD,FILM:4K OHM,0.1%,0.125W,TC=T9 | 19701 | 5033RE4K00B |
| A22R121 | 315-0512-00 | | | RES,FXD,FILM:5.1K OHM,5%,0.25W | 57668 | NTR25J-E05K1 |
| A22R122 | 315-0201-00 | B031871 | | RES,FXD,FILM:200 OHM,5%,0.25W | 57668 | NTR25J-E200E |
| A22R126 | 315-0131-00 | | | RES,FXD,FILM:130 OHM,5%,0.25W | 19701 | 5043CX130R0J |
| A22R127 | 315-0203-00 | | | RES,FXD,FILM:20K OHM,5%,0.25W | 57668 | NTR25J-E 20K |
| A22R128 | 315-0203-00 | | | RES,FXD,FILM:20K OHM,5%,0.25W | 57668 | NTR25J-E 20K |
| A22R129 | 315-0101-00 | | | RES,FXD,FILM:100 OHM,5%,0.25W | 57668 | NTR25J-E 100E |
| A22R131 | 315-0362-00 | | | RES,FXD,FILM:3.6K OHM,5%,0.25W | 19701 | 5043CX3K600J |
| A22R132 | 315-0151-00 | | | RES,FXD,FILM:150 OHM,5%,0.25W | 57668 | NTR25J-E150E |
| A22R133 | 308-0804-00 | | | RES,FXD,WV:0.025 OHM,5%,0.5W | 80009 | 308-0804-00 |
| A22R134 | 308-0804-00 | | | RES,FXD,WV:0.025 OHM,5%,0.5W | 80009 | 308-0804-00 |
| A22R135 | 315-0470-00 | | | RES,FXD,FILM:470 OHM,5%,0.25W | 57668 | NTR25J-E470E |

Replaceable Electrical Parts - 7904A

| Component No. | Tektronix Part No. | Serial/Assembly No. Effective | Discont | Name & Description | Mfr. Code | Mfr. Part No. |
|---------------|--------------------|-------------------------------|---------|---|-----------|-----------------|
| A22R136 | 315-0432-00 | | | RES,FXD,FILM:4.3K OHM,5%,0.25W | 57668 | NTR25J-E04K3 |
| A22R141 | 315-0822-00 | | | RES,FXD,FILM:8.2K OHM,5%,0.25W | 19701 | 5043CX8K200J |
| A22R142 | 315-0103-00 | | | RES,FXD,FILM:10K OHM,5%,0.25W | 19701 | 5043CX10K00J |
| A22R143 | 315-0243-00 | | | RES,FXD,FILM:24K OHM,5%,0.25W | 57668 | NTR25J-E24K0 |
| A22R144 | 315-0562-00 | | | RES,FXD,FILM:5.6K OHM,5%,0.25W | 57668 | NTR25J-E05K6 |
| A22R145 | 315-0221-00 | | | RES,FXD,FILM:220 OHM,5%,0.25W | 57668 | NTR25J-E220E |
| A22R148 | 308-0702-00 | | | RES,FXD,WW:0.33 OHM,5%,2W | 75042 | SPH-R3300J |
| A22R152 | 301-0561-00 | | | RES,FXD,FILM:560 OHM,5%,0.5W | 01121 | EB5615 |
| A22R156 | 301-0431-00 | | | RES,FXD,FILM:430 OHM,5%,0.5W | 19701 | 5053CX430R0J |
| A22U15 | 156-0067-12 | B010100 | B010784 | MICROCKT,LINER:OPERATIONAL AMPLIFIER | 01295 | UA741CJG |
| A22U15 | 156-0067-01 | B010785 | B041970 | MICROCKT,LINER:OPNL AMPL,CHECKED | 04713 | MC1741CP1DS |
| A22U15 | 156-0067-00 | B041971 | | MICROCKT,LINER:BIPOLAR,OPNL AMPL | 04713 | MC1741CP1 |
| A22U45 | 156-0067-12 | B010100 | B010784 | MICROCKT,LINER:OPERATIONAL AMPLIFIER | 01295 | UA741CJG |
| A22U45 | 156-0067-01 | B010785 | B041970 | MICROCKT,LINER:OPNL AMPL,CHECKED | 04713 | MC1741CP1DS |
| A22U45 | 156-0067-00 | B041971 | | MICROCKT,LINER:BIPOLAR,OPNL AMPL | 04713 | MC1741CP1 |
| A22U64 | 156-0158-04 | | | MICROCKT,LINER:DUAL OPNL AMPL | 01295 | MC1458JG |
| A22U84 | 156-0158-04 | | | MICROCKT,LINER:DUAL OPNL AMPL | 01295 | MC1458JG |
| A22U114 | 156-0158-04 | | | MICROCKT,LINER:DUAL OPNL AMPL | 01295 | MC1458JG |
| A22VR10 | 152-0217-00 | | | SEMICON DVC,DI:ZEN,SI,8.2V,5%,0.4W,DO-7 | 04713 | SZG20 |
| A22VR12 | 152-0212-00 | | | SEMICON DVC,DI:ZEN,SI,9V,5%,0.5W,DO-7 | 04713 | SZ50646RL |
| A22VR17 | 152-0283-00 | | | SEMICON DVC,DI:ZEN,SI,43V,5%,0.4W,D-07 | 04713 | 1N976B |
| A22VR32 | 152-0281-00 | | | SEMICON DVC,DI:ZEN,SI,22V,5%,0.4W,DO-7 | 12954 | 1N969B/DO-35 |
| A22VR36 | 152-0281-00 | | | SEMICON DVC,DI:ZEN,SI,22V,5%,0.4W,DO-7 | 12954 | 1N969B/DO-35 |
| A22VR47 | 152-0283-00 | | | SEMICON DVC,DI:ZEN,SI,43V,5%,0.4W,D-07 | 04713 | 1N976B |
| A22VR152 | 152-0175-01 | | | SEMICON DVC,DI:ZEN,SI,5.6V,5%,0.4W,DO-7 | 04713 | SZG5021RL |
| A22VR156 | 152-0175-01 | | | SEMICON DVC,DI:ZEN,SI,5.6V,5%,0.4W,DO-7 | 04713 | SZG5021RL |
| A23 | 670-6259-01 | B010100 | B019999 | CIRCUIT BD ASSY:INVERTER | 80009 | 670-6259-01 |
| A23 | 670-6259-02 | B020000 | | CIRCUIT BD ASSY:INVERTER (PART OF 620-0283-02) | 80009 | 670-6259-02 |
| A23C5 | 283-0022-00 | B010100 | B019999 | CAP,FXD,CER DI:0.02UF,+100-0%,1400V | 59660 | 3888531Z5U0203Z |
| A23C5 | 119-1168-00 | B020000 | | CAPACITOR-RES:0.1UF,20% & 22 OHM,10%,250VAC | 14752 | RG1782-1 |
| A23C6 | 283-0022-00 | B010100 | B019999 | CAP,FXD,CER DI:0.02UF,+100-0%,1400V | 59660 | 3888531Z5U0203Z |
| A23C19 | 283-0057-00 | | | CAP,FXD,CER DI:0.1UF,+80-20%,200V | 04222 | SR306E104ZAA |
| A23C27 | 283-0280-00 | B010100 | B019999 | CAP,FXD,CER DI:2200PF,10%,2000V | 60705 | 564CBA202EH222 |
| A23C27 | 283-0351-00 | B020000 | | CAP,FXD,CER DI:5000PF,20%,3000V | 51406 | DHR17Z5U502M3KV |
| A23C28 | 283-0280-00 | B010100 | B019999 | CAP,FXD,CER DI:2200PF,10%,2000V | 60705 | 564CBA202EH222 |
| A23C28 | 283-0351-00 | B020000 | | CAP,FXD,CER DI:5000PF,20%,3000V | 51406 | DHR17Z5U502M3KV |
| A23C29 | 285-0939-00 | | | CAP,FXD,PLASTIC:3UF,5%,400V | 04099 | TEK13-17 |
| A23C31 | 290-0891-00 | | | CAP,FXD,ELCTLT:1UF,+75 -10%,50V | 55680 | ULA1H010TEA |
| A23C35 | 283-0060-00 | | | CAP,FXD,CER DI:100PF,5%,200V | 59660 | 855-535U2J101J |
| A23C36 | 283-0280-00 | | | CAP,FXD,CER DI:2200PF,10%,2000V | 60705 | 564CBA202EH222 |
| A23C38 | 283-0279-00 | | | CAP,FXD,CER DI:0.001UF,20%,3000V | 51406 | DHR12Y5S102M3KV |
| A23C39 | 290-0891-00 | | | CAP,FXD,ELCTLT:1UF,+75 -10%,50V | 55680 | ULA1H010TEA |
| A23C42 | 283-0079-00 | | | CAP,FXD,CER DI:0.01UF,20%,250V | 04222 | SR503C103MAA |
| A23C43 | 290-0767-00 | | | CAP,FXD,ELCTLT:4.7UF,+75-10%,160VDC | 54473 | ECEA2CS4R7 |
| A23CR15 | 152-0396-01 | B010100 | B019999 | SEMICON DVC,DI:RECT,SI,400V,3A | 14936 | KBPC604-1 |
| A23CR15 | 152-0750-00 | B020000 | | SEMICON DVC,DI:RECT,BRIDGE,SI,3A,250NS | 05828 | RKBPC606-12 |
| A23CR32 | 152-0107-00 | | | SEMICON DVC,DI:RECT,SI,400 V,400MA,A1 | 12969 | "G727" |
| A23CR33 | 152-0400-00 | | | SEMICON DVC,DI:RECT,SI,400V,1A | 04713 | SR1977K |
| A23CR34 | 152-0400-00 | | | SEMICON DVC,DI:RECT,SI,400V,1A | 04713 | SR1977K |
| A23CR36 | 152-0061-00 | | | SEMICON DVC,DI:SW,SI,175V,0.1A,DO-35 | 07263 | FDH2161 |
| A23CR37 | 152-0061-00 | | | SEMICON DVC,DI:SW,SI,175V,0.1A,DO-35 | 07263 | FDH2161 |
| A23CR38 | 152-0107-00 | | | SEMICON DVC,DI:RECT,SI,400 V,400MA,A1 | 12969 | "G727" |
| A23CR39 | 152-0400-00 | | | SEMICON DVC,DI:RECT,SI,400V,1A | 04713 | SR1977K |
| A23CR40 | 152-0107-00 | | | SEMICON DVC,DI:RECT,SI,400 V,400MA,A1 | 12969 | "G727" |
| A23CR41 | 152-0400-00 | | | SEMICON DVC,DI:RECT,SI,400V,1A | 04713 | SR1977K |
| A23CR45 | 152-0061-00 | | | SEMICON DVC,DI:SW,SI,175V,0.1A,DO-35 | 07263 | FDH2161 |
| A23CR46 | 152-0581-00 | | | SEMICON DVC,DI:RECT,SI,20V,1A,A59 | 04713 | 1N5817 |

| Component No. | Tektronix Part No. | Serial/Assembly No. Effective | Discont | Name & Description | Mfr. Code | Mfr. Part No. |
|---------------|--------------------|-------------------------------|---------|---|-----------|------------------|
| A23CR49 | 152-0107-00 | | | SEMICON DVC,DI:RECT,SI,400 V,400MA,A1 | 12969 | "G727" |
| A23DS19 | 150-0035-00 | | | LAMP,GLOW:90V MAX,0.3MA,AID-T,WIRE LD | TK0213 | JH005/3011JA |
| A23E8 | 119-0181-00 | | | ARSR,ELEC SURGE:230,GAS FILLED | 25088 | B1-A230 |
| A23E13 | 119-0181-00 | | | ARSR,ELEC SURGE:230,GAS FILLED | 25088 | B1-A230 |
| A23L24 | 108-0681-00 | | | COIL,RF:FIXED,140UH | TK1345 | 108-0681-00 |
| A23Q30 | 151-0508-00 | | | TRANSISTOR:UJT,SI,TO-98 | 03508 | X13T520 |
| A23Q34 | 151-0632-00 | | | TRANSISTOR:NPN,SILICON,TO-220 | 04713 | MJE13007 |
| A23Q40 | 151-0632-00 | | | TRANSISTOR:NPN,SILICON,TO-220 | 04713 | MJE13007 |
| A23Q43 | 151-0347-00 | | | TRANSISTOR:NPN,SI,TO-92 | 04713 | SPS7951 |
| A23Q45 | 151-0350-00 | | | TRANSISTOR:PNP,SI,TO-92 | 04713 | SPS6700 |
| A23Q46 | 151-0260-00 | | | TRANSISTOR:NPN,SI,TO-39 | 80009 | 151-0260-00 |
| A23R5 | 304-0270-00 | B010100 | B019999 | RES,FXD,CMPSN:27 OHM,10%,1W | 01121 | GB2701 |
| A23R8 | 308-0503-00 | B010100 | B019999 | RES,FXD,WW:6.8 OHM,5%,2.5W | 14193 | SA31-6R8QJ |
| A23R9 | 304-0473-00 | | | RES,FXD,CMPSN:47K OHM,10%,1W | 01121 | GB4731 |
| A23R10 | 303-0184-00 | | | RES,FXD,CMPSN:180K OHM,5%,1W | 01121 | GB1845 |
| A23R12 | 308-0503-00 | B010100 | B019999 | RES,FXD,WW:6.8 OHM,5%,2.5W | 14193 | SA31-6R8QJ |
| A23R13 | 304-0473-00 | | | RES,FXD,CMPSN:47K OHM,10%,1W | 01121 | GB4731 |
| A23R19 | 302-0565-00 | | | RES,FXD,CMPSN:5.6M OHM,10%,0.5W | 01121 | EB5651 |
| A23R21 | 304-0154-00 | | | RES,FXD,CMPSN:150K OHM,10%,1W | 01121 | GB 1541 |
| A23R25 | 315-0471-00 | | | RES,FXD,FILM:470 OHM,5%,0.25W | 57668 | NTR25J-E470E |
| A23R31 | 303-0100-00 | | | RES,FXD,CMPSN:10 OHM,5%,1W | 01121 | GB1005 |
| A23R32 | 315-0220-00 | | | RES,FXD,FILM:22 OHM,5%,0.25W | 19701 | 5043CX22R00J |
| A23R36 | 315-0103-00 | | | RES,FXD,FILM:10K OHM,5%,0.25W | 19701 | 5043CX10K00J |
| A23R37 | 301-0200-00 | | | RES,FXD,FILM:20 OHM,5%,0.5W | 19701 | 5053CX20R00J |
| A23R38 | 315-0332-00 | | | RES,FXD,FILM:3.3K OHM,5%,0.25W | 57668 | NTR25J-E03K3 |
| A23R39 | 301-0200-00 | | | RES,FXD,FILM:20 OHM,5%,0.5W | 19701 | 5053CX20R00J |
| A23R40 | 315-0220-00 | | | RES,FXD,FILM:22 OHM,5%,0.25W | 19701 | 5043CX22R00J |
| A23R41 | 315-0753-00 | | | RES,FXD,FILM:75K OHM,5%,0.25W | 57668 | NTR25J-E75K0 |
| A23R42 | 315-0303-00 | | | RES,FXD,FILM:30K OHM,5%,0.25W | 19701 | 5043CX30K00J |
| A23R43 | 315-0274-00 | | | RES,FXD,FILM:270K OHM,5%,0.25W | 57668 | NTR25J-E270K |
| A23R44 | 315-0270-00 | | | RES,FXD,FILM:27 OHM,5%,0.25W | 19701 | 5043CX27R00J |
| A23R45 | 315-0182-00 | | | RES,FXD,FILM:1.8K OHM,5%,0.25W | 57668 | NTR25J-E1K8 |
| A23R46 | 315-0123-00 | | | RES,FXD,FILM:12K OHM,5%,0.25W | 57668 | NTR25J-E12K0 |
| A23R47 | 301-0184-00 | | | RES,FXD,FILM:180K OHM,5%,0.5W | 57668 | TR50J-E180K |
| A23RT9 | 307-0353-00 | | | RES,THERMAL:5 OHM,10% | 15454 | 5DA5R0K270SS-SIL |
| A23RT13 | 307-0353-00 | | | RES,THERMAL:5 OHM,10% | 15454 | 5DA5R0K270SS-SIL |
| A23T8 | 120-0636-00 | | | XFMR,PWR,STPDN:LINE TRIGGER | 75498 | 120-0636-00 |
| A23T25 | 120-0743-00 | | | XFMR,TOROID: | 80009 | 120-0743-00 |
| A23T30 | 120-0744-00 | | | XFMR,TOROID:5 WINDINGS | TK1345 | 120-0744-00 |
| A23T35 | 120-0747-00 | | | XFMR,TOROID: | TK1345 | 120-0747-00 |
| A23TP31 | 214-0579-00 | B010100 | B042116 | TERM,TEST POINT:BRS CD PL | 80009 | 214-0579-00 |
| A23TP34 | 214-0579-00 | | | TERM,TEST POINT:BRS CD PL | 80009 | 214-0579-00 |
| A23TP38 | 214-0579-00 | B010100 | B042116 | TERM,TEST POINT:BRS CD PL | 80009 | 214-0579-00 |
| A23TP46 | 214-0579-00 | | | TERM,TEST POINT:BRS CD PL | 80009 | 214-0579-00 |
| A23VR38 | 152-0241-00 | | | SEMICON DVC,DI:ZEN,SI,33V,5%,0.4W,DO-7 | 14552 | 1N973B |
| A23VR45 | 152-0428-00 | | | SEMICON DVC,DI:ZEN,SI,120V,5%,0.4W,DO-7 | 04713 | SZ13202 (1N987B) |
| A23W5 | 131-0566-00 | B020000 | | BUS,CONDUCTOR:DUMMY RES,0.094 OD X 0.225 L | 24546 | OMA 07 |
| A24 | 119-1048-00 | | | DELAY LINE,ELEC:65NS,50 OHMS (NO ELECTRICAL PARTS) | 80009 | 119-1048-00 |
| A24DL5 | ----- | | | (NOT AVAILABLE,USE A24) | | |
| A25 | 670-8052-00 | | | CIRCUIT BD ASSY:FRONT PANEL DISPLAY | 80009 | 670-8052-00 |
| A25P20 | 131-1149-00 | | | CONTACT,ELEC:CKT BD EDGE,PH BRZ SIL PL (QUANTITY OF 2) | 80009 | 131-1149-00 |
| A25P21 | 131-1149-00 | | | CONTACT,ELEC:CKT BD EDGE,PH BRZ SIL PL (QUANTITY OF 2) | 80009 | 131-1149-00 |
| A25P22 | 131-1149-00 | | | CONTACT,ELEC:CKT BD EDGE,PH BRZ SIL PL (QUANTITY OF 2) | 80009 | 131-1149-00 |
| A26 | 670-8053-00 | | | CIRCUIT BD ASSY:FRONT PANEL DISPLAY | 80009 | 670-8053-00 |

Replaceable Electrical Parts - 7904A

| Component No. | Tektronix Part No. | Serial/Assembly No. Effective | Discont | Name & Description | Mfr. Code | Mfr. Part No. |
|---------------|--------------------|-------------------------------|---------|---|-----------|----------------|
| A26P20 | 131-1149-00 | | | CONTACT,ELEC:CKT BD EDGE,PH BRZ SIL PL (QUANTITY OF 2) | 80009 | 131-1149-00 |
| A26P21 | 131-1149-00 | | | CONTACT,ELEC:CKT BD EDGE,PH BRZ SIL PL (QUANTITY OF 2) | 80009 | 131-1149-00 |
| A26P22 | 131-1149-00 | | | CONTACT,ELEC:CKT BD EDGE,PH BRZ SIL PL (QUANTITY OF 2) | 80009 | 131-1149-00 |
| A27 | 670-4346-00 | | | CIRCUIT BD ASSY:READOUT PROTECTION #1 (PART OF 672-0572-00) | 80009 | 670-4346-00 |
| A27CR2235 | 152-0333-00 | | | SEMICON DVC,DI:SW,SI,55V,200MA,DO-35 | 07263 | FDH-6012 |
| A27CR2236 | 152-0333-00 | | | SEMICON DVC,DI:SW,SI,55V,200MA,DO-35 | 07263 | FDH-6012 |
| A27CR2237 | 152-0333-00 | | | SEMICON DVC,DI:SW,SI,55V,200MA,DO-35 | 07263 | FDH-6012 |
| A27CR2238 | 152-0333-00 | | | SEMICON DVC,DI:SW,SI,55V,200MA,DO-35 | 07263 | FDH-6012 |
| A27CR2239 | 152-0333-00 | | | SEMICON DVC,DI:SW,SI,55V,200MA,DO-35 | 07263 | FDH-6012 |
| A27CR2240 | 152-0333-00 | | | SEMICON DVC,DI:SW,SI,55V,200MA,DO-35 | 07263 | FDH-6012 |
| A27CR2241 | 152-0333-00 | | | SEMICON DVC,DI:SW,SI,55V,200MA,DO-35 | 07263 | FDH-6012 |
| A27CR2242 | 152-0333-00 | | | SEMICON DVC,DI:SW,SI,55V,200MA,DO-35 | 07263 | FDH-6012 |
| A27CR2243 | 152-0333-00 | | | SEMICON DVC,DI:SW,SI,55V,200MA,DO-35 | 07263 | FDH-6012 |
| A27CR2244 | 152-0333-00 | | | SEMICON DVC,DI:SW,SI,55V,200MA,DO-35 | 07263 | FDH-6012 |
| A27CR2245 | 152-0333-00 | | | SEMICON DVC,DI:SW,SI,55V,200MA,DO-35 | 07263 | FDH-6012 |
| A27CR2246 | 152-0333-00 | | | SEMICON DVC,DI:SW,SI,55V,200MA,DO-35 | 07263 | FDH-6012 |
| A27CR2247 | 152-0333-00 | | | SEMICON DVC,DI:SW,SI,55V,200MA,DO-35 | 07263 | FDH-6012 |
| A27CR2248 | 152-0333-00 | | | SEMICON DVC,DI:SW,SI,55V,200MA,DO-35 | 07263 | FDH-6012 |
| A27CR2249 | 152-0333-00 | | | SEMICON DVC,DI:SW,SI,55V,200MA,DO-35 | 07263 | FDH-6012 |
| A27CR2250 | 152-0333-00 | | | SEMICON DVC,DI:SW,SI,55V,200MA,DO-35 | 07263 | FDH-6012 |
| A27CR2251 | 152-0333-00 | | | SEMICON DVC,DI:SW,SI,55V,200MA,DO-35 | 07263 | FDH-6012 |
| A27CR2252 | 152-0333-00 | | | SEMICON DVC,DI:SW,SI,55V,200MA,DO-35 | 07263 | FDH-6012 |
| A27CR2253 | 152-0333-00 | | | SEMICON DVC,DI:SW,SI,55V,200MA,DO-35 | 07263 | FDH-6012 |
| A27CR2254 | 152-0333-00 | | | SEMICON DVC,DI:SW,SI,55V,200MA,DO-35 | 07263 | FDH-6012 |
| A27CR2255 | 152-0333-00 | | | SEMICON DVC,DI:SW,SI,55V,200MA,DO-35 | 07263 | FDH-6012 |
| A27CR2256 | 152-0333-00 | | | SEMICON DVC,DI:SW,SI,55V,200MA,DO-35 | 07263 | FDH-6012 |
| A27CR2257 | 152-0333-00 | | | SEMICON DVC,DI:SW,SI,55V,200MA,DO-35 | 07263 | FDH-6012 |
| A27CR2258 | 152-0333-00 | | | SEMICON DVC,DI:SW,SI,55V,200MA,DO-35 | 07263 | FDH-6012 |
| A27CR2259 | 152-0333-00 | | | SEMICON DVC,DI:SW,SI,55V,200MA,DO-35 | 07263 | FDH-6012 |
| A27CR2260 | 152-0333-00 | | | SEMICON DVC,DI:SW,SI,55V,200MA,DO-35 | 07263 | FDH-6012 |
| A27CR2261 | 152-0333-00 | | | SEMICON DVC,DI:SW,SI,55V,200MA,DO-35 | 07263 | FDH-6012 |
| A27CR2262 | 152-0333-00 | | | SEMICON DVC,DI:SW,SI,55V,200MA,DO-35 | 07263 | FDH-6012 |
| A27CR2263 | 152-0333-00 | | | SEMICON DVC,DI:SW,SI,55V,200MA,DO-35 | 07263 | FDH-6012 |
| A27CR2264 | 152-0333-00 | | | SEMICON DVC,DI:SW,SI,55V,200MA,DO-35 | 07263 | FDH-6012 |
| A27CR2265 | 152-0333-00 | | | SEMICON DVC,DI:SW,SI,55V,200MA,DO-35 | 07263 | FDH-6012 |
| A27CR2266 | 152-0333-00 | | | SEMICON DVC,DI:SW,SI,55V,200MA,DO-35 | 07263 | FDH-6012 |
| A27CR2267 | 152-0333-00 | | | SEMICON DVC,DI:SW,SI,55V,200MA,DO-35 | 07263 | FDH-6012 |
| A27P2265 | 131-0589-00 | | | TERMINAL,PIN:0.46 L X 0.025 SQ PH BRZ (QUANTITY OF 10) | 22526 | 48283-029 |
| A27P2266 | 131-0589-00 | | | TERMINAL,PIN:0.46 L X 0.025 SQ PH 8RZ (QUANTITY OF 10) | 22526 | 48283-029 |
| A28 | 670-1632-05 | B010100 | B010768 | CIRCUIT BD ASSY:MAIN HORIZONTAL AMP | 80009 | 670-1632-05 |
| A28 | 670-1632-06 | B010769 | | CIRCUIT BD ASSY:HORIZONTAL AMPLIFIER | 80009 | 670-1632-06 |
| A28C100 | 290-0778-00 | | | CAP,FXD,ELCTLT:1UF,20%,50V,NPLZD | 54473 | ECE-A50N1 |
| A28C122 | 281-0792-00 | | | CAP,FXD,CER DI:82PF,10%,100V | 04222 | SA102A820KAA |
| A28C260 | 290-0745-00 | | | CAP,FXD,ELCTLT:22UF,+50-20%,25WVDC | 54473 | ECE-A25V22L |
| A28C300 | 281-0812-00 | | | CAP,FXD,CER DI:1000PF,10%,100V | 04222 | MA101C102KAA |
| A28C310 | 281-0123-00 | | | CAP,VAR,CER DI:5-25PF,100V | 59660 | 518-000A5-25 |
| A28C340 | 281-0123-00 | | | CAP,VAR,CER DI:5-25PF,100V | 59660 | 51B-000A5-25 |
| A28C350 | 281-0812-00 | | | CAP,FXD,CER DI:1000PF,10%,100V | 04222 | MA101C102KAA |
| A28C360 | 290-0745-00 | | | CAP,FXD,ELCTLT:22UF,+50-20%,25WVDC | 54473 | ECE-A25V22L |
| A28C420 | 281-0788-00 | | | CAP,FXD,CER DI:470PF,10%,100V | 04222 | SA102C471KAA |
| A28C430 | 283-0260-00 | | | CAP,FXD,CER DI:5.6PF,+/-0.25PF,200V | 51642 | 150 200NP0569C |
| A28C440 | 281-0788-00 | | | CAP,FXD,CER DI:470PF,10%,100V | 04222 | SA102C471KAA |
| A28C542 | 281-0773-00 | | | CAP,FXD,CER DI:0.01UF,10%,100V | 04222 | MA201C103KAA |

| Component No. | Tektronix Part No. | Serial/Assembly No. Effective | Discont | Name & Description | Mfr. Code | Mfr. Part No. |
|---------------|--------------------|-------------------------------|---------|--|-----------|------------------|
| A28C550 | 281-0773-00 | | | CAP, FXD, CER 01: 0.01UF, 10%, 100V | 04222 | MA201C103KAA |
| A28C660 | 283-0003-00 | | | CAP, FXD, CER DI: 0.01UF, +80-20%, 150V | 59821 | D103Z40Z5UJDC EX |
| A28C810 | 281-0166-00 | | | CAP, VAR, AIR 01: 1.9-15.7 PF, 250V | 74970 | 187-0109-055 |
| A28C811 | 283-0647-00 | | | CAP, FXD, MICA DI: 70PF, 1%, 100V | 00853 | D155E700F0 |
| A28C811 | 283-0633-00 | 8021160 | | CAP, FXD, MICA DI: 77PF, 1%, 100V (C811 IS SELECTABLE) | 00853 | D155E770F0 |
| A28C840 | 283-0647-00 | | | CAP, FXD, MICA DI: 70PF, 1%, 100V | 00853 | D155E700F0 |
| A28C840 | 283-0633-00 | 8021160 | | CAP, FXD, MICA DI: 77PF, 1%, 100V (C840 IS SELECTABLE) | 00853 | 0155E770F0 |
| A28C850 | 281-0166-00 | | | CAP, VAR, AIR 01: 1.9-15.7 PF, 250V | 74970 | 187-0109-055 |
| A28C860 | 283-0005-00 | | | CAP, FXD, CER DI: 0.01UF, +100-0%, 250V | 04222 | SR303E103ZAA |
| A28C910 | 281-0773-00 | | | CAP, FXD, CER DI: 0.01UF, 10%, 100V | 04222 | MA201C103KAA |
| A28C911 | 281-0659-00 | | | CAP, FXD, CER 01: 4.3PF, +/-0.25PF, 500V | 52763 | 2RDPLZ007 4P30CC |
| A28C920 | 281-0773-00 | | | CAP, FXD, CER DI: 0.01UF, 10%, 100V | 04222 | MA201C103KAA |
| A28C922 | 281-0123-00 | | | CAP, VAR, CER DI: 5-25PF, 100V | 59660 | 518-000A5-25 |
| A28C930 | 283-0003-00 | | | CAP, FXD, CER DI: 0.01UF, +80-20%, 150V | 59821 | D103Z40Z5UJDC EX |
| A28C931 | 283-0003-00 | | | CAP, FXD, CER DI: 0.01UF, +80-20%, 150V | 59821 | 0103Z40Z5UJDC EX |
| A28C940 | 283-0003-00 | | | CAP, FXD, CER DI: 0.01UF, +80-20%, 150V | 59821 | D103Z40Z5UJDC EX |
| A28C943 | 281-0773-00 | | | CAP, FXD, CER DI: 0.01UF, 10%, 100V | 04222 | MA201C103KAA |
| A28C950 | 281-0659-00 | | | CAP, FXD, CER DI: 4.3PF, +/-0.25PF, 500V | 52763 | 2RDPLZ007 4P30CC |
| A28CR720 | 152-0141-02 | | | SEMICONV DVC, DI: SW, SI, 30V, 150MA, 30V, D0-35 | 03508 | DA2527 (1N4152) |
| A28CR740 | 152-0141-02 | | | SEMICONV DVC, DI: SW, SI, 30V, 150MA, 30V, D0-35 | 03508 | DA2527 (1N4152) |
| A28J5 | 131-1003-00 | | | CONN, RCPT, ELEC: CKT BD MT, 3 PRONG | 80009 | 131-1003-00 |
| A28J6 | 131-1003-00 | | | CONN, RCPT, ELEC: CKT BD MT, 3 PRONG | 80009 | 131-1003-00 |
| A28J12 | 131-1003-00 | | | CONN, RCPT, ELEC: CKT BD MT, 3 PRONG | 80009 | 131-1003-00 |
| A28L160 | 108-0245-00 | | | CHOKE, RF: FIXED, 3.9UH | 76493 | B6310-1 |
| A28L161 | 108-0245-00 | | | CHOKE, RF: FIXED, 3.9UH | 76493 | B6310-1 |
| A28L220 | 108-0578-00 | | | COIL, RF: FIXED, 19NH | TK1345 | 108-0578-00 |
| A28L230 | 108-0578-00 | | | COIL, RF: FIXED, 19NH | TK1345 | 108-0578-00 |
| A28L942 | 108-0707-00 | | | COIL, RF: FIXED, 128NH | TK1345 | 108-0707-00 |
| A28P59 | 131-0608-00 | | | TERMINAL, PIN: 0.365 L X 0.025 BRZ GLD PL (QUANTITY OF 2) | 22526 | 48283-036 |
| A28P95 | 131-0608-00 | | | TERMINAL, PIN: 0.365 L X 0.025 BRZ GLD PL (QUANTITY OF 8) | 22526 | 48283-036 |
| A28Q140 | 151-0190-00 | | | TRANSISTOR: NPN, SI, T0-92 | 80009 | 151-0190-00 |
| A28Q320 | 151-0221-00 | | | TRANSISTOR: PNP, SI, T0-92 | 80009 | 151-0221-00 |
| A28Q321 | 151-0221-00 | | | TRANSISTOR: PNP, SI, T0-92 | 80009 | 151-0221-00 |
| A28Q330 | 151-0221-00 | | | TRANSISTOR: PNP, SI, T0-92 | 80009 | 151-0221-00 |
| A28Q340 | 151-0221-00 | | | TRANSISTOR: PNP, SI, T0-92 | 80009 | 151-0221-00 |
| A28Q410 | 151-0220-00 | | | TRANSISTOR: PNP, SI, T0-92 | 80009 | 151-0220-00 |
| A28Q420 | 151-0220-07 | | | TRANSISTOR: PNP, SI, 600MHZ | 80009 | 151-0220-07 |
| A28Q430 | 151-0220-07 | | | TRANSISTOR: PNP, SI, 600MHZ | 80009 | 151-0220-07 |
| A28Q620 | 151-0220-07 | | | TRANSISTOR: PNP, SI, 600MHZ | 80009 | 151-0220-07 |
| A28Q621 | 151-0434-00 | 8010100 | 8010140 | TRANSISTOR: PNP, SI, T0-72 | 04713 | SS7144 |
| A28Q621 | 151-0434-01 | 8010141 | | TRANSISTOR: SELECTED | 04713 | SS7144H |
| A28Q630 | 151-0198-00 | | | TRANSISTOR: SELECTED | 80009 | 151-0198-00 |
| A28Q640 | 151-0220-07 | | | TRANSISTOR: PNP, SI, 600MHZ | 80009 | 151-0220-07 |
| A28Q810 | 151-0220-07 | | | TRANSISTOR: PNP, SI, 600MHZ | 80009 | 151-0220-07 |
| A28Q820 | 151-0220-07 | | | TRANSISTOR: PNP, SI, 600MHZ | 80009 | 151-0220-07 |
| A28Q830 | 151-0190-00 | | | TRANSISTOR: NPN, SI, T0-92 | 80009 | 151-0190-00 |
| A28Q850 | 151-0302-00 | | | TRANSISTOR: NPN, SI, T0-18 | 04713 | ST899 |
| A28Q910 | 151-0274-00 | 8010100 | 8010140 | TRANSISTOR: NPN, SI, T0-5 | 04713 | SS7394 |
| A28Q910 | 151-0274-01 | 8010141 | | TRANSISTOR: SCREENED | 04713 | SS7394H |
| A28Q920 | 151-0270-00 | 8010100 | 8010140 | TRANSISTOR: PNP, SI, T0-39 | 04713 | ST919 |
| A28Q920 | 151-0270-03 | 8010141 | | TRANSISTOR: SCREENED | 04713 | ST919H |
| A28Q930 | 151-0270-00 | 8010100 | 8010140 | TRANSISTOR: PNP, SI, T0-39 | 04713 | ST919 |
| A28Q930 | 151-0270-03 | 8010141 | | TRANSISTOR: SCREENED | 04713 | ST919H |
| A28Q940 | 151-0274-00 | 8010100 | 8010140 | TRANSISTOR: NPN, SI, T0-5 | 04713 | SS7394 |
| A28Q940 | 151-0274-01 | 8010141 | | TRANSISTOR: SCREENED | 04713 | SS7394H |

Replaceable Electrical Parts - 7904A

| Component No. | Tektronix Part No. | Serial/Assembly No. Effective Dscont | Name & Description | Mfr. Code | Mfr. Part No. |
|---------------|--------------------|--------------------------------------|---|-----------|-----------------|
| A28R100 | 315-0100-00 | | RES,FXD,FILM:10 OHM,5%,0.25W | 19701 | 5043CX10RR00J |
| A28R101 | 311-0605-00 | | RES,VAR,NONWV:TRMR,200 OHM,0.5W | 32997 | 3329H-G48-201 |
| A28R110 | 321-0251-00 | | RES,FXD,FILM:4.02K OHM,1%,0.125W,TC=TO | 19701 | 5033ED4K020F |
| A28R111 | 321-0193-00 | | RES,FXD,FILM:1K OHM,1%,0.125W,TC=TO | 19701 | 5033ED1K00F |
| A28R112 | 321-0078-00 | | RES,FXD,FILM:63.4 OHM,1%,0.125W,TC=TO | 91637 | CMF551166G3R40F |
| A28R113 | 315-0822-00 | | RES,FXD,FILM:8.2K OHM,5%,0.25W | 19701 | 5043CX8K200J |
| A28R114 | 311-0607-00 | | RES,VAR,NONWV:TRMR,10K OHM,0.5W | 73138 | 82-25-2 |
| A28R120 | 323-0167-00 | | RES,FXD,FILM:536 OHM,1%,0.5W,TC=TO | 07716 | CECD536ROF |
| A28R121 | 311-0609-00 | | RES,VAR,NONWV:TRMR,2K OHM,0.5W | 32997 | 3329H-L58-202 |
| A28R122 | 321-0135-00 | | RES,FXD,FILM:249 OHM,1%,0.125W,TC=TO | 07716 | CEAD249ROF |
| A28R123 | 315-0822-00 | | RES,FXD,FILM:8.2K OHM,5%,0.25W | 19701 | 5043CX8K200J |
| A28R130 | 315-0563-00 | | RES,FXD,FILM:56K OHM,5%,0.25W | 19701 | 5043CX56K00J |
| A28R131 | 321-0135-00 | | RES,FXD,FILM:249 OHM,1%,0.125W,TC=TO | 07716 | CEAD249ROF |
| A28R132 | 323-0167-00 | | RES,FXD,FILM:536 OHM,1%,0.5W,TC=TO | 07716 | CECD536ROF |
| A28R133 | 321-0078-00 | | RES,FXD,FILM:63.4 OHM,1%,0.125W,TC=TO | 91637 | CMF551166G3R40F |
| A28R140 | 315-0822-00 | | RES,FXD,FILM:8.2K OHM,5%,0.25W | 19701 | 5043CX8K200J |
| A28R141 | 321-0193-00 | | RES,FXD,FILM:1K OHM,1%,0.125W,TC=TO | 19701 | 5033ED1K00F |
| A28R142 | 315-0222-00 | | RES,FXD,FILM:2.2K OHM,5%,0.25W | 57668 | NTR25J-E02K2 |
| A28R150 | 307-0106-00 | | RES,FXD,CMPSN:4.7 OHM,5%,0.25W | 01121 | CB 47G5 |
| A28R220 | 315-0300-00 | | RES,FXD,FILM:30 OHM,5%,0.25W | 19701 | 5043CX30R00J |
| A28R221 | 321-0155-00 | | RES,FXD,FILM:402 OHM,1%,0.125W,TC=TO | 07716 | CEAD402ROF |
| A28R230 | 311-0634-00 | | RES,VAR,NONWV:TRMR,500 OHM,0.5W | 32997 | 3329H-L58-501 |
| A28R231 | 315-0300-00 | | RES,FXD,FILM:30 OHM,5%,0.25W | 19701 | 5043CX30R00J |
| A28R232 | 321-0119-00 | | RES,FXD,FILM:169 OHM,1%,0.125W,TC=TO | 07716 | CEAD169ROF |
| A28R240 | 311-0613-00 | | RES,VAR,NONWV:TRMR,100K OHM,0.5W | 32997 | 3329H-G48-104 |
| A28R300 | 321-0167-00 | | RES,FXD,FILM:536 OHM,1%,0.125W,TC=TO | 07716 | CEAD536ROF |
| A28R301 | 321-0228-00 | | RES,FXD,FILM:2.32K OHM,1%,0.125W,TC=TO | 19701 | 5043ED2K32F |
| A28R302 | 315-0473-00 | | RES,FXD,FILM:47K OHM,5%,0.25W | 57668 | NTR25J-E47K0 |
| A28R310 | 321-0228-00 | | RES,FXD,FILM:2.32K OHM,1%,0.125W,TC=TO | 19701 | 5043ED2K32F |
| A28R311 | 321-0120-00 | | RES,FXD,FILM:174 OHM,1%,0.125W,TC=TO | 80009 | 321-0120-00 |
| A28R312 | 311-0605-00 | | RES,VAR,NONWV:TRMR,200 OHM,0.5W | 32997 | 3329H-G48-201 |
| A28R320 | 315-0300-00 | | RES,FXD,FILM:30 OHM,5%,0.25W | 19701 | 5043CX30R00J |
| A28R321 | 315-0101-00 | | RES,FXD,FILM:100 OHM,5%,0.25W | 57668 | NTR25J-E 100E |
| A28R322 | 321-0185-00 | | RES,FXD,FILM:825 OHM,1%,0.125W,TC=TO | 07716 | CEAD825ROF |
| A28R330 | 321-0119-00 | | RES,FXD,FILM:169 OHM,1%,0.125W,TC=TO | 07716 | CEAD169ROF |
| A28R331 | 315-0101-00 | | RES,FXD,FILM:100 OHM,5%,0.25W | 57668 | NTR25J-E 100E |
| A28R332 | 315-0300-00 | | RES,FXD,FILM:30 OHM,5%,0.25W | 19701 | 5043CX30R00J |
| A28R340 | 311-0605-00 | | RES,VAR,NONWV:TRMR,200 OHM,0.5W | 32997 | 3329H-G48-201 |
| A28R341 | 321-0120-00 | | RES,FXD,FILM:174 OHM,1%,0.125W,TC=TO | 80009 | 321-0120-00 |
| A28R350 | 315-0103-00 | | RES,FXD,FILM:10K OHM,5%,0.25W | 19701 | 5043CX10K00J |
| A28R351 | 321-0228-00 | | RES,FXD,FILM:2.32K OHM,1%,0.125W,TC=TO | 19701 | 5043ED2K32F |
| A28R352 | 321-0228-00 | | RES,FXD,FILM:2.32K OHM,1%,0.125W,TC=TO | 19701 | 5043ED2K32F |
| A28R420 | 315-0181-00 | | RES,FXD,FILM:180 OHM,5%,0.25W | 57668 | NTR25J-E180E |
| A28R440 | 315-0181-00 | | RES,FXD,FILM:180 OHM,5%,0.25W | 57668 | NTR25J-E180E |
| A28R522 | 315-0102-00 | | RES,FXD,FILM:1K OHM,5%,0.25W | 57668 | NTR25JE01K0 |
| A28R523 | 315-0300-00 | | RES,FXD,FILM:30 OHM,5%,0.25W | 19701 | 5043CX30R00J |
| A28R530 | 315-0432-00 | | RES,FXD,FILM:4.3K OHM,5%,0.25W | 57668 | NTR25J-E04K3 |
| A28R531 | 315-0220-00 | | RES,FXD,FILM:22 OHM,5%,0.25W | 19701 | 5043CX22R00J |
| A28R532 | 315-0300-00 | | RES,FXD,FILM:30 OHM,5%,0.25W | 19701 | 5043CX30R00J |
| A28R540 | 315-0102-00 | | RES,FXD,FILM:1K OHM,5%,0.25W | 57668 | NTR25JE01K0 |
| A28R542 | 315-0220-00 | | RES,FXD,FILM:22 OHM,5%,0.25W | 19701 | 5043CX22R00J |
| A28R560 | 307-0106-00 | | RES,FXD,CMPSN:4.7 OHM,5%,0.25W | 01121 | CB 47G5 |
| A28R610 | 323-0706-01 | | RES,FXD,FILM:800 OHM,0.5%,0.5W,TC=TO | 07716 | CECD800ROD |
| A28R630 | 311-0635-00 | | RES,VAR,NONWV:TRMR,1K OHM,0.5W | 32997 | 3329H-L58-102 |
| A28R640 | 323-0706-01 | | RES,FXD,FILM:800 OHM,0.5%,0.5W,TC=TO | 07716 | CECD800ROD |
| A28R650 | 308-0304-00 | | RES,FXD,WW:1.5K OHM,1%,3W | 44655 | 43F1K5 |
| A28R700 | 308-0304-00 | | RES,FXD,WW:1.5K OHM,1%,3W | 44655 | 43F1K5 |
| A28R720 | 321-0066-00 | | RES,FXD,FILM:47.5 OHM,0.5%,0.125W,TC=TO | 91637 | CMF55116G47R50F |

| Component No. | Tektronix Part No. | Serial/Assembly No. Effective | Discont | Name & Description | Mfr. Code | Mfr. Part No. |
|---------------|--------------------|-------------------------------|---------|--|-----------|------------------|
| A28R721 | 315-0102-00 | | | RES,FXD,FILM:1K OHM,5%,0.25W | 57668 | NTR25JE01K0 |
| A28R722 | 321-0205-00 | | | RES,FXD,FILM:1.33K OHM,1%,0.125W,TC=TO | 19701 | 5033ED1K330F |
| A28R723 | 321-0264-00 | B010100 | B010768 | RES,FXD,FILM:5.49K OHM,1%,0.125W,TC=TO | 07716 | CEAD54900C |
| A28R723 | 321-0262-00 | B010769 | | RES,FXD,FILM:5.23K OHM,1,0.125W,TC=TO | 19701 | 5033ED5K230F |
| A28R730 | 315-0911-00 | | | RES,FXD,FILM:910 OHM,5%,0.25W | 57668 | NTR25J-E910E |
| A28R731 | 315-0822-00 | | | RES,FXD,FILM:8.2K OHM,5%,0.25W | 19701 | 5043CX8K200J |
| A28R732 | 315-0751-00 | | | RES,FXD,FILM:750 OHM,5%,0.25W | 57668 | NTR25J-E750E |
| A28R733 | 315-0332-00 | | | RES,FXD,FILM:3.3K OHM,5%,0.25W | 57668 | NTR25J-E03K3 |
| A28R734 | 321-0275-00 | B010100 | B010768 | RES,FXD,FILM:7.15K OHM,1%,0.125W,TC=TO | 07716 | CEAD71500F |
| A28R734 | 321-0276-00 | B010769 | | RES,FXD,FILM:7.32K OHM,1%,0.125W,TC=TO | 19701 | 5043ED7K320F |
| A28R740 | 321-0205-00 | | | RES,FXD,FILM:1.33K OHM,1%,0.125W,TC=TO | 19701 | 5033ED1K330F |
| A28R741 | 315-0102-00 | | | RES,FXD,FILM:1K OHM,5%,0.25W | 57668 | NTR25JE01K0 |
| A28R742 | 321-0066-00 | | | RES,FXD,FILM:47.5 OHM,0.5%,0.125W,TC=TO | 91637 | CMF55116G47R50F |
| A28R760 | 307-0106-00 | | | RES,FXD,CMPSN:4.7 OHM,5%,0.25W | 01121 | CB 47G5 |
| A28R900 | 303-0332-00 | | | RES,FXD,CMPSN:3.3K OHM,5%,1W | 01121 | GB3325 |
| A28R910 | 315-0271-00 | | | RES,FXD,FILM:270 OHM,5%,0.25W | 57668 | NTR25J-E270E |
| A28R911 | 315-0100-00 | | | RES,FXD,FILM:10 OHM,5%,0.25W | 19701 | 5043CX10RR00J |
| A28R920 | 323-0327-00 | | | RES,FXD,FILM:24.9K OHM,1%,0.5W,TC=TO | 91637 | MFF1226G24901F |
| A28R921 | 301-0563-00 | | | RES,FXD,FILM:56K OHM,5%,0.5W | 19701 | 5053CX56K00J |
| A28R922 | 315-0201-00 | | | RES,FXD,FILM:200 OHM,5%,0.25W | 57668 | NTR25J-E200E |
| A28R923 | 315-0150-00 | | | RES,FXD,FILM:15 OHM,5%,0.25W | 19701 | 5043CX15R00J |
| A28R924 | 321-0218-00 | | | RES,FXD,FILM:1.82K OHM,1%,0.125W,TC=TO | 19701 | 5033ED1K82F |
| A28R930 | 321-0205-00 | | | RES,FXD,FILM:1.33K OHM,1%,0.125W,TC=TO | 19701 | 5033ED1K330F |
| A28R940 | 323-0327-00 | | | RES,FXD,FILM:24.9K OHM,1%,0.5W,TC=TO | 91637 | MFF1226G24901F |
| A28R941 | 303-0273-00 | | | RES,FXD,CMPSN:27K OHM,5%,1W | 01121 | GB2735 |
| A28R942 | 315-0201-00 | | | RES,FXD,FILM:200 OHM,5%,0.25W | 57668 | NTR25J-E200E |
| A28R943 | 315-0100-00 | | | RES,FXD,FILM:10 OHM,5%,0.25W | 19701 | 5043CX10RR00J |
| A28R950 | 315-0270-00 | | | RES,FXD,FILM:27 OHM,5%,0.25W | 19701 | 5043CX27R00J |
| A28R951 | 303-0272-00 | | | RES,FXD,CMPSN:2.7 OHM,5%,1W | 01121 | GB2725 |
| A28R952 | 301-0333-00 | | | RES,FXD,FILM:33K OHM,5%,0.5W | 19701 | 5053CX33K00J |
| A28R960 | 303-0222-00 | | | RES,FXD,CMPSN:2.2K OHM,5%,1W | 01121 | GB2225 |
| A28RT233 | 307-0122-00 | | | RES,THERMAL:50 HM,10%,NTC | 14193 | 1B15-500K |
| A28TP150 | 214-0579-00 | | | TERM,TEST POINT:BRS CD PL | 80009 | 214-0579-00 |
| A28TP151 | 214-0579-00 | | | TERM,TEST POINT:BRS CD PL | 80009 | 214-0579-00 |
| A28TP152 | 214-0579-00 | | | TERM,TEST POINT:BRS CD PL | 80009 | 214-0579-00 |
| A28TP153 | 214-0579-00 | | | TERM,TEST POINT:BRS CD PL | 80009 | 214-0579-00 |
| A28TP160 | 214-0579-00 | | | TERM,TEST POINT:BRS CD PL | 80009 | 214-0579-00 |
| A28TP161 | 214-0579-00 | | | TERM,TEST POINT:BRS CD PL | 80009 | 214-0579-00 |
| A28TP550 | 214-0579-00 | | | TERM,TEST POINT:BRS CD PL | 80009 | 214-0579-00 |
| A28TP610 | 214-0579-00 | | | TERM,TEST POINT:BRS CD PL | 80009 | 214-0579-00 |
| A28TP750 | 214-0579-00 | | | TERM,TEST POINT:BRS CD PL | 80009 | 214-0579-00 |
| A28VR930 | 152-0149-00 | | | SEMICON DVC,DI:ZEN,SI,10V,5%,0.4W,DO-7 | 04713 | 1N961B |
| A28VR950 | 152-0282-00 | | | SEMICON DVC,DI:ZEN,SI,30V,2%,400MW,DO-35 | 14552 | 1N972B |
| A29 | 670-8059-00 | | | CIRCUIT BD ASSY:HORIZONTAL INTERCONNECT | 80009 | 670-8059-00 |
| A29C606 | 281-0505-00 | | | CAP,FXD,CER DI:12PF,10%,500V | 59660 | 301-000COGO-120K |
| A29C622 | 281-0505-00 | | | CAP,FXD,CER DI:12PF,10%,500V | 59660 | 301-000COGO-120K |
| A29DS304 | 150-0097-00 | | | LAMP,INCAND:6.3V,0.2A,#7381,WIRE LEADS | 92966 | 7381 |
| A29DS305 | 150-0097-00 | | | LAMP,INCAND:6.3V,0.2A,#7381,WIRE LEADS | 92966 | 7381 |
| A29DS306 | 150-0097-00 | | | LAMP,INCAND:6.3V,0.2A,#7381,WIRE LEADS | 92966 | 7381 |
| A29J126 | 131-1003-00 | | | CONN,RCPT,ELEC:CKT BD MT,3 PRONG | 80009 | 131-1003-00 |
| A29J220 | 131-1003-00 | | | CONN,RCPT,ELEC:CKT BD MT,3 PRONG | 80009 | 131-1003-00 |
| A29J226 | 131-1003-00 | | | CONN,RCPT,ELEC:CKT BD MT,3 PRONG | 80009 | 131-1003-00 |
| A29J320 | 131-1003-00 | | | CONN,RCPT,ELEC:CKT BD MT,3 PRONG | 80009 | 131-1003-00 |
| A29J602 | 131-1003-00 | | | CONN,RCPT,ELEC:CKT BD MT,3 PRONG | 80009 | 131-1003-00 |
| A29J612 | 131-1003-00 | | | CONN,RCPT,ELEC:CKT BD MT,3 PRONG | 80009 | 131-1003-00 |
| A29J614 | 131-1003-00 | | | CONN,RCPT,ELEC:CKT BD MT,3 PRONG | 80009 | 131-1003-00 |
| A29J616 | 131-1003-00 | | | CONN,RCPT,ELEC:CKT BD MT,3 PRONG | 80009 | 131-1003-00 |
| A29J620 | 131-1003-00 | | | CONN,RCPT,ELEC:CKT BD MT,3 PRONG | 80009 | 131-1003-00 |

Replaceable Electrical Parts - 7904A

| Component No. | Tektronix Part No. | Serial/Assembly No. Effective | Discont | Name & Description | Mfr. Code | Mfr. Part No. |
|---------------|--------------------|-------------------------------|---------|--|-----------|------------------|
| A29J624 | 131-1003-00 | | | CONN, RCPT, ELEC:CKT BD MT, 3 PRONG | 80009 | 131-1003-00 |
| A29J626 | 131-1003-00 | | | CONN, RCPT, ELEC:CKT BD MT, 3 PRONG | 80009 | 131-1003-00 |
| A29P90 | 131-0589-00 | | | TERMINAL, PIN:0.46 L X 0.025 SQ PH BRZ (QUANTITY OF 6) | 22526 | 48283-029 |
| A29Q400 | 151-0301-00 | | | TRANSISTOR:PMP, SI, TO-18 | 80009 | 151-0301-00 |
| A29Q422 | 151-0302-00 | | | TRANSISTOR:NPN, SI, TO-18 | 04713 | ST899 |
| A29Q424 | 151-0302-00 | | | TRANSISTOR:NPN, SI, TO-18 | 04713 | ST899 |
| A29R122 | 311-1227-00 | | | RES, VAR, NONNW:TRMR, 5K OHM, 0.5W | 32997 | 3386F-T04-502 |
| A29R506 | 321-1068-01 | | | RES, FXD, FILM:50.5 OHM, 0.5%, 0.125W, TC=TO | 57668 | RB14 DXE 50E5 |
| A29R516 | 321-1068-01 | | | RES, FXD, FILM:50.5 OHM, 0.5%, 0.125W, TC=TO | 57668 | RB14 DXE 50E5 |
| A29R522 | 315-0332-00 | | | RES, FXD, FILM:3.3K OHM, 5%, 0.25W | 57668 | NTR25J-E03K3 |
| A29R523 | 315-0101-00 | | | RES, FXD, FILM:100 OHM, 5%, 0.25W | 57668 | NTR25J-E 100E |
| A29R524 | 315-0682-00 | | | RES, FXD, FILM:6.8K OHM, 5%, 0.25W | 57668 | NTR25J-E06K8 |
| A29R526 | 315-0511-00 | | | RES, FXD, FILM:510 OHM, 5%, 0.25W | 19701 | 5043CX510R0J |
| A29R528 | 321-1068-01 | | | RES, FXD, FILM:50.5 OHM, 0.5%, 0.125W, TC=TO | 57668 | RB14 DXE 50E5 |
| A29R602 | 321-1068-01 | | | RES, FXD, FILM:50.5 OHM, 0.5%, 0.125W, TC=TO | 57668 | RB14 DXE 50E5 |
| A29R603 | 321-0074-00 | | | RES, FXD, FILM:57.6 OHM, 1%, 0.125W, TC=TO | 91637 | CMF55116G57R60F |
| A29R604 | 321-0074-00 | | | RES, FXD, FILM:57.6 OHM, 1%, 0.125W, TC=TO | 91637 | CMF55116G57R60F |
| A29R606 | 321-0187-00 | | | RES, FXD, FILM:866 OHM, 1%, 0.125W, TC=TO | 07716 | CEAD866ROF |
| A29R620 | 321-0074-00 | | | RES, FXD, FILM:57.6 OHM, 1%, 0.125W, TC=TO | 91637 | CMF55116G57R60F |
| A29R622 | 321-0074-00 | | | RES, FXD, FILM:57.6 OHM, 1%, 0.125W, TC=TO | 91637 | CMF55116G57R60F |
| A29R624 | 321-0218-00 | | | RES, FXD, FILM:1.82K OHM, 1%, 0.125W, TC=TO | 19701 | 5033ED1K82F |
| A29R626 | 321-0187-00 | | | RES, FXD, FILM:866 OHM, 1%, 0.125W, TC=TO | 07716 | CEAD866ROF |
| A29U518 | 155-0022-00 | | | MICROCKT, DCTL:CHANNEL SWITCH | 80009 | 155-0022-00 |
| A30 | 670-0702-06 | | | CIRCUIT BD ASSY:GRATICULE LAMPS | 80009 | 670-0702-06 |
| A30DS304 | 150-0097-00 | | | LAMP, INCAND:6.3V, 0.2A, #7381, WIRE LEADS | 92966 | 7381 |
| A30DS305 | 150-0097-00 | | | LAMP, INCAND:6.3V, 0.2A, #7381, WIRE LEADS | 92966 | 7381 |
| A30DS306 | 150-0097-00 | | | LAMP, INCAND:6.3V, 0.2A, #7381, WIRE LEADS | 92966 | 7381 |
| A31 | 670-8046-00 | | | CIRCUIT BD ASSY:FLEX CON (PART OF 672-1176-00.NO ELEC PARTS) | 80009 | 670-8046-00 |
| C81 | 283-0003-00 | | | CAP, FXD, CER DI:0.01UF, +80-20%, 150V | 59821 | D103Z40Z5UJDCX |
| C154 | 290-0898-00 | B010100 | B031832 | CAP, FXD, ELCTLT:2600UF, +75-10%, 35V | 56289 | 602DX262G035AA2B |
| C154 | 290-0898-01 | B031833 | | CAP, FXD, ELCTLT:2600UF, +75 -10%, 35V | 56289 | 602DX262G035AA2P |
| DS308 | 150-0121-02 | | | LAMP, CARTRIDGE:5V, 0.06A, GREEN LENS (PART OF 198-3762-XX) | 55292 | 71320-03 |
| DS2002 | 150-0048-01 | | | LAMP, INCAND:5V, 0.06A, #683, AGED & SEL | 58854 | 683AS15 |
| DS2003 | 150-0048-01 | | | LAMP, INCAND:5V, 0.06A, #683, AGED & SEL | 58854 | 683AS15 |
| J130 | 131-0765-01 | | | TERM, FEEDTHRU:0.584 L X 0.625 OD, BRS (QUANTITY OF 3) | 80009 | 131-0765-01 |
| J497 | 131-1315-01 | | | CONN, RCPT, ELEC:BNC, FEMALE | 80009 | 131-1315-01 |
| J1925 | 131-1315-01 | | | CONN, RCPT, ELEC:BNC, FEMALE | 80009 | 131-1315-01 |
| J1944 | 131-1315-01 | | | CONN, RCPT, ELEC:BNC, FEMALE | 80009 | 131-1315-01 |
| L21 | 108-0544-00 | B010100 | B010579 | COIL, TUBE DEFL:TRACE ROTATOR | 80009 | 108-0544-00 |
| L21 | 108-0544-01 | B010580 | | COIL, TUBE DEFL:TRACE ROTATOR | 80009 | 108-0544-01 |
| L22 | 108-0605-00 | | | COIL, TUBE DEFL:TRACE ROTATOR | 80009 | 108-0605-00 |
| L156 | 108-0337-00 | | | COIL, RF:FIXED, 25UH | B0009 | 108-0337-00 |
| LR780 | 108-0685-00 | | | COIL, RF:FIXED, 39NH | TK1345 | 108-0685-00 |
| LR784 | 108-0685-00 | | | COIL, RF:FIXED, 39NH | TK1345 | 108-0685-00 |
| Q28 | 151-0656-00 | | | TRANSISTOR:DARLINGTON, NPN, SI, TO-220 | 02735 | 2N6044 |
| Q58 | 151-0657-00 | | | TRANSISTOR:DARLINGTON, PNP, SI, TO-220 | 04713 | SJE1973 |
| Q74 | 151-0656-00 | | | TRANSISTOR:DARLINGTON, NPN, SI, TO-220 | 02735 | 2N6044 |
| Q94 | 151-0657-00 | | | TRANSISTOR:DARLINGTON, PNP, SI, TO-220 | 04713 | SJE1973 |
| Q122 | 151-0349-00 | | | TRANSISTOR:NPN, SI, SELECTED, TO-127 | 04713 | SJE924 |
| Q126 | 151-0477-01 | | | TRANSISTOR:SCREENED | 80009 | 151-0477-01 |
| R83 | 307-0292-24 | | | RES, FXD, FILM:(2)175 OHM, (2)33.7 OHM | 80009 | 307-0292-24 |
| S10 | 260-1709-00 | | | SWITCH, PUSH:DPST, 15A, 250VAC, PUSH-PUSH | 77342 | A9M1-762-6-3 |
| V21 | 154-0644-05 | B010100 | B031782 | ELECTRON TUBE:CRT, P31, INT SC | 80009 | 154-0644-05 |

| Component No. | Tektronix Part No. | Serial/Assembly No. Effective | Discont | Name & Description | Mfr. Code | Mfr. Part No. |
|---------------|--------------------|-------------------------------|---------|--|-----------|---------------|
| V21 | 154-0893-05 | B031783 | | ELECTRON TUBE:FINISHED T7900-31-2 | 80009 | 154-0893-05 |
| V21 | 154-0661-05 | | | ELECTRON TUBE:CRT,P31,INT SC (OPTION 04 ONLY) | 80009 | 154-0661-05 |
| V21 | 154-0661-10 | | | ELECTRON TUBE:CRT,P11,INT SC (OPTION 13 ONLY) | 80009 | 154-0661-10 |
| V21 | 154-0644-09 | | | ELECTRON TUBE:CRT,P11,INT SC (OPTION 78 ONLY) | 80009 | 154-0644-09 |

DIAGRAMS AND CIRCUIT BOARD ILLUSTRATIONS

Symbols

Graphic symbols and class designation letters are based on ANSI Standard Y32.2-1975.

Logic symbology is based on ANSI Y32.14-1973 in terms of positive logic. Logic symbols depict the logic function performed and may differ from the manufacturer's data.

The overline on a signal name indicates that the signal performs its intended function when it is in the low state.

Abbreviations are based on ANSI Y1.1-1972.

Other ANSI standards that are used in the preparation of diagrams by Tektronix, Inc. are:

- Y14.15, 1966 Drafting Practices.
- Y14.2, 1973 Line Conventions and Lettering.
- Y10.5, 1968 Letter Symbols for Quantities Used in Electrical Science and Electrical Engineering.

American National Standard Institute
1430 Broadway
New York, New York 10018

Component Values

Electrical components shown on the diagrams are in the following units unless noted otherwise:

- Capacitors = Values one or greater are in picofarads (pF). Values less than one are in microfarads (μ F).
- Resistors = Ohms (Ω).

———— The information and special symbols below may appear in this manual. ————

Assembly Numbers and Grid Coordinates

Each assembly in the instrument is assigned an assembly number (e.g., A20). The assembly number appears on the circuit board outline on the diagram, in the title for the circuit board component location illustration, and in the lookup table for the schematic diagram and corresponding component locator illustration. The Replaceable Electrical Parts list is arranged by assemblies in numerical sequence; the components are listed by component number *(see following illustration for constructing a component number).

The schematic diagram and circuit board component location illustration have grids. A lookup table with the grid coordinates is provided for ease of locating the component. Only the components illustrated on the facing diagram are listed in the lookup table. When more than one schematic diagram is used to illustrate the circuitry on a circuit board, the circuit board illustration may only appear opposite the first diagram on which it was illustrated; the lookup table will list the diagram number of other diagrams that the circuitry of the circuit board appears on.

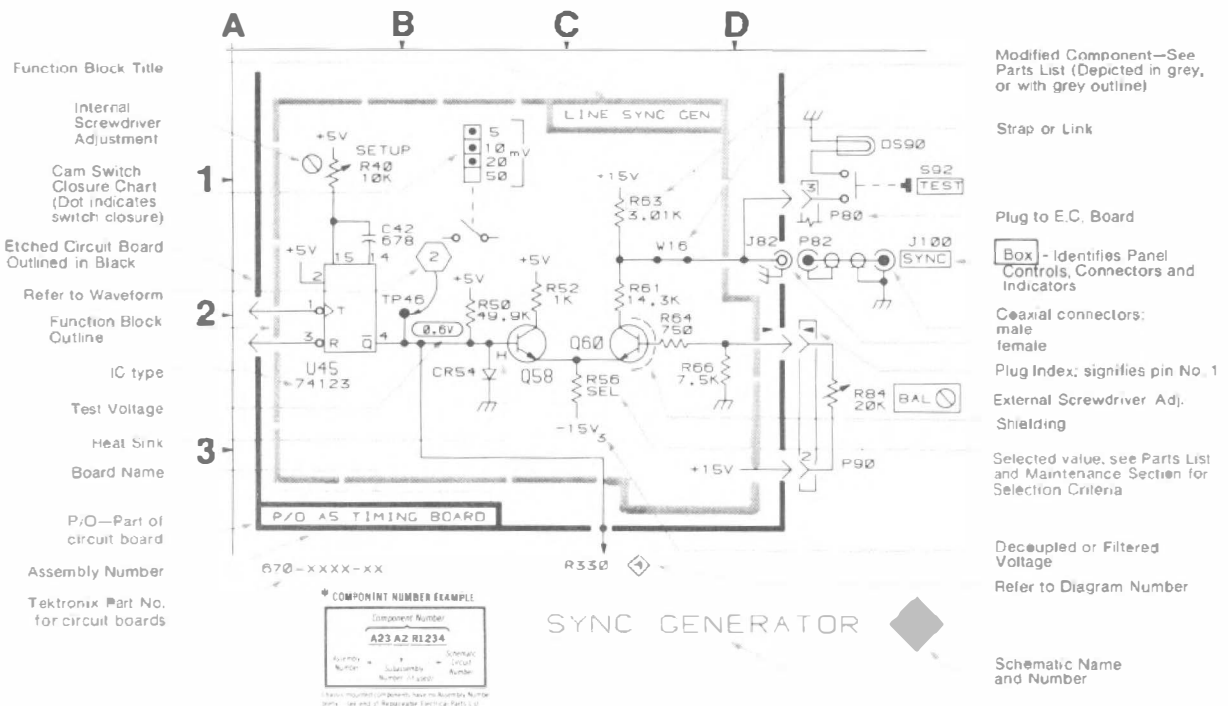

| Assembly Number | Board Name | Diagram Number | Board Name | Assembly Number | Diagram Number |
|-----------------|-----------------------------------|----------------|-----------------------------------|-----------------|----------------|
| A1 | Front Panel | 2,7 | A Trigger Source Light | A3 | 2 |
| A2 | Display Control | 2 | A,B Horiz Follower | A9-A10 | 3 |
| A3 | A Trigger Source Light | 2 | A,B Trigger Follower | A25-A26 | 3 |
| A4 | B Trigger Source Light | 2 | B Trigger Source Light | A4 | 2 |
| A5 | Mode Switch | 2,7 | Control Rectifier | A12 | 14 |
| A6 | Main Interface | 2,3,4 | Delay Line | A24 | 9 |
| A7-A8 | Left, Right Vert Channel Follower | 3 | Display Control | A2 | 2 |
| A9-A10 | A,B Horiz Follower | 3 | Fan | A11 | 15 |
| A11 | Fan | 15 | Front Panel | A1 | 2,7 |
| A12 | Control Rectifier | 14 | Graticule Lights | A30 | 2 |
| A13 | Logic | 2,4 | High Voltage | A20 | 13 |
| A14 | Trigger Selector | 2,5 | Horizontal Amplifier | A28 | 11 |
| A15 | Readout System | 6 | Horizontal Interconnect | A19 | 10 |
| A16 | Vertical Channel Switch | 8 | Horizontal Interface | A29 | 10 |
| A17 (Option 2) | X-Y Delay Compensation | 10 | Left, Right Vert Channel Follower | A7-A8 | 3 |
| A18 | Vertical Amplifier | 9 | Logic | A13 | 2,4 |
| A19 | Horizontal Interconnect | 10 | Low-Voltage Regulator | A22 | 14,15 |
| A20 | High Voltage | 13 | Main Interface | A6 | 2,3,4 |
| A21 | Z-Axis | 12 | Mode Switch | A5 | 2,7 |
| A22 | Low-Voltage Regulator | 14,15 | Power Supply Inverter | A23 | 14 |
| A23 | Power Supply Inverter | 14 | Protection Circuit | A27 | 6 |
| A24 | Delay Line | 9 | Readout System | A15 | 6 |
| A25-A26 | A,B, Trig Follower | 3 | Trigger Selector | A14 | 2,5 |
| A27 | Protection Circuit | 6 | Vertical Amplifier | A18 | 9 |
| A28 | Horizontal Amplifier | 11 | Vertical Channel Switch | A16 | 8 |
| A29 | Horizontal Interface | 10 | Vertical Flexcon | A31 | 9 |
| A30 | Graticule Lights | 2 | X-Y Delay | A17 (Option 2) | 10 |
| A31 | Vertical Flexcon | 9 | Z-Axis | A21 | 12 |

Figure 8-1. 7904A board

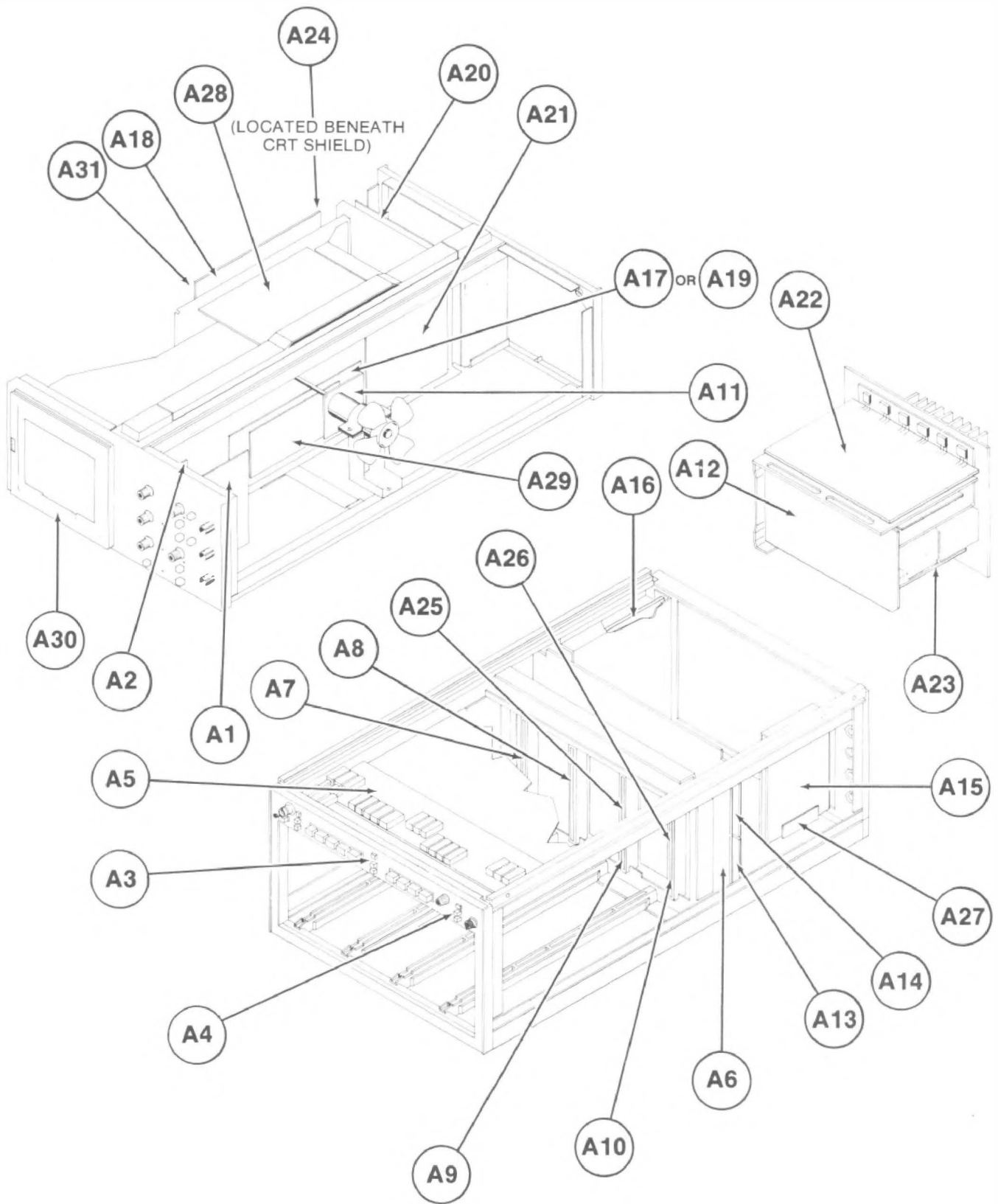

NOTE
LEAD CONFIGURATIONS AND CASE STYLES ARE TYPICAL, BUT MAY VARY DUE TO VENDOR CHANGES OR INSTRUMENT MODIFICATIONS.

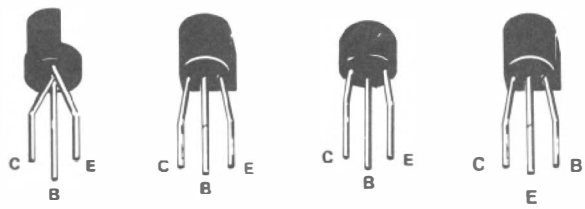

PLASTIC-CASED TRANSISTORS

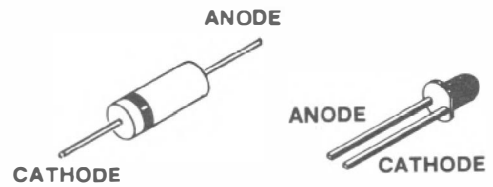

SIGNAL DIODE

LIGHT EMITTING DIODE (L.E.D.)

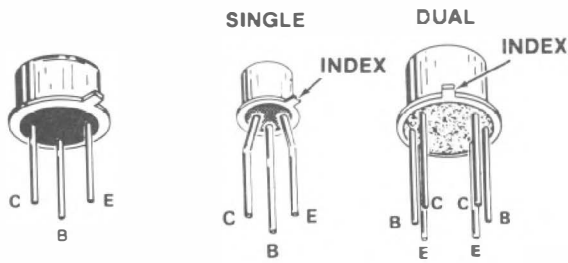

METAL-CASED TRANSISTORS



PLASTIC-POWER TRANSISTOR

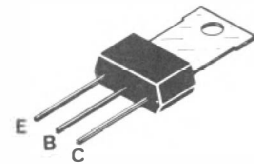

DARLINGTON TRANSISTOR



FET

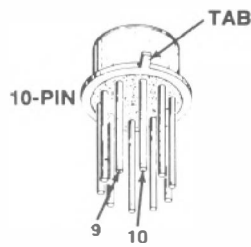

10-PIN

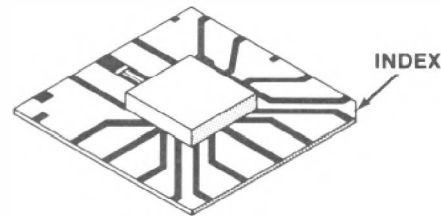

INDEX

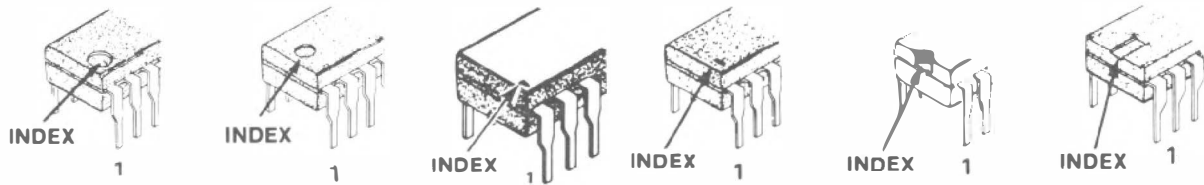

IC PINS ARE NUMBERED COUNTERCLOCKWISE FROM THE INDEX (VIEWED FROM THE TOP).

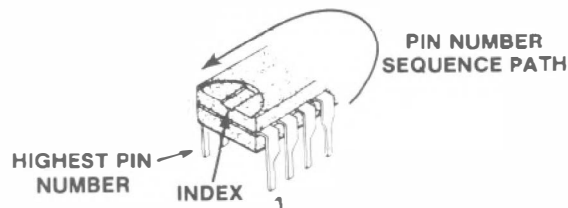

PIN NUMBER SEQUENCE PATH

HIGHEST PIN NUMBER

INTEGRATED CIRCUITS

4593-401A

Figure 8-2. Semiconductor lead configurations.

REV MAR 1984

CHASSIS MOUNTED PARTS

| CIRCUIT NUMBER | SCHEM NUMBER | SCHEM LOCATION | CIRCUIT NUMBER | SCHEM NUMBER | SCHEM LOCATION |
|----------------|--------------|----------------|----------------|--------------|----------------|
| A7 | 3 | B3 | | | |
| A8 | 3 | C3 | FL10 | 14 | A3 |
| A9 | 3 | F3 | | | |
| A10 | 3 | D3 | J81 | 3 | G3 |
| A14 | 3 | C5 | J85 | 3 | G3 |
| A19 | 10 | E3 | J95 | 3 | A4 |
| A25 | 3 | D2 | J396 | 2 | H2 |
| A26 | 3 | F2 | J497 | 5 | G1 |
| A31 | 9 | G1 | J1916 | 7 | B6 |
| A31 | 9 | G3 | J1925 | 7 | E1 |
| | | | J1944 | 7 | F1 |
| C37 | 14 | D1 | | | |
| C81 | 9 | H2 | L37 | 14 | D1 |
| | | | L81 | 9 | H2 |
| DS304 | 2 | A5 | L82 | 9 | H2 |
| DS305 | 2 | A5 | | | |
| DS306 | 2 | A5 | P10 | 14 | A4 |
| DS308 | 2 | A4 | P11 | 14 | A3 |
| DS342 | 2 | D4 | P314 | 2 | A4 |
| DS345 | 2 | E4 | P346 | 2 | D4 |
| DS346 | 2 | E4 | P366 | 2 | F4 |
| DS362 | 2 | F4 | | | |
| DS365 | 2 | F4 | R81 | 9 | G2 |
| DS366 | 2 | F4 | R82 | 9 | G2 |
| DS2002 | 2 | C5 | R83 | 9 | G2 |
| DS2002 | 4 | G4 | | | |
| DS2003 | 2 | C5 | S10 | 14 | A3 |
| DS2003 | 4 | G4 | S99 | 15 | C3 |
| F10 | 14 | A3 | | | |

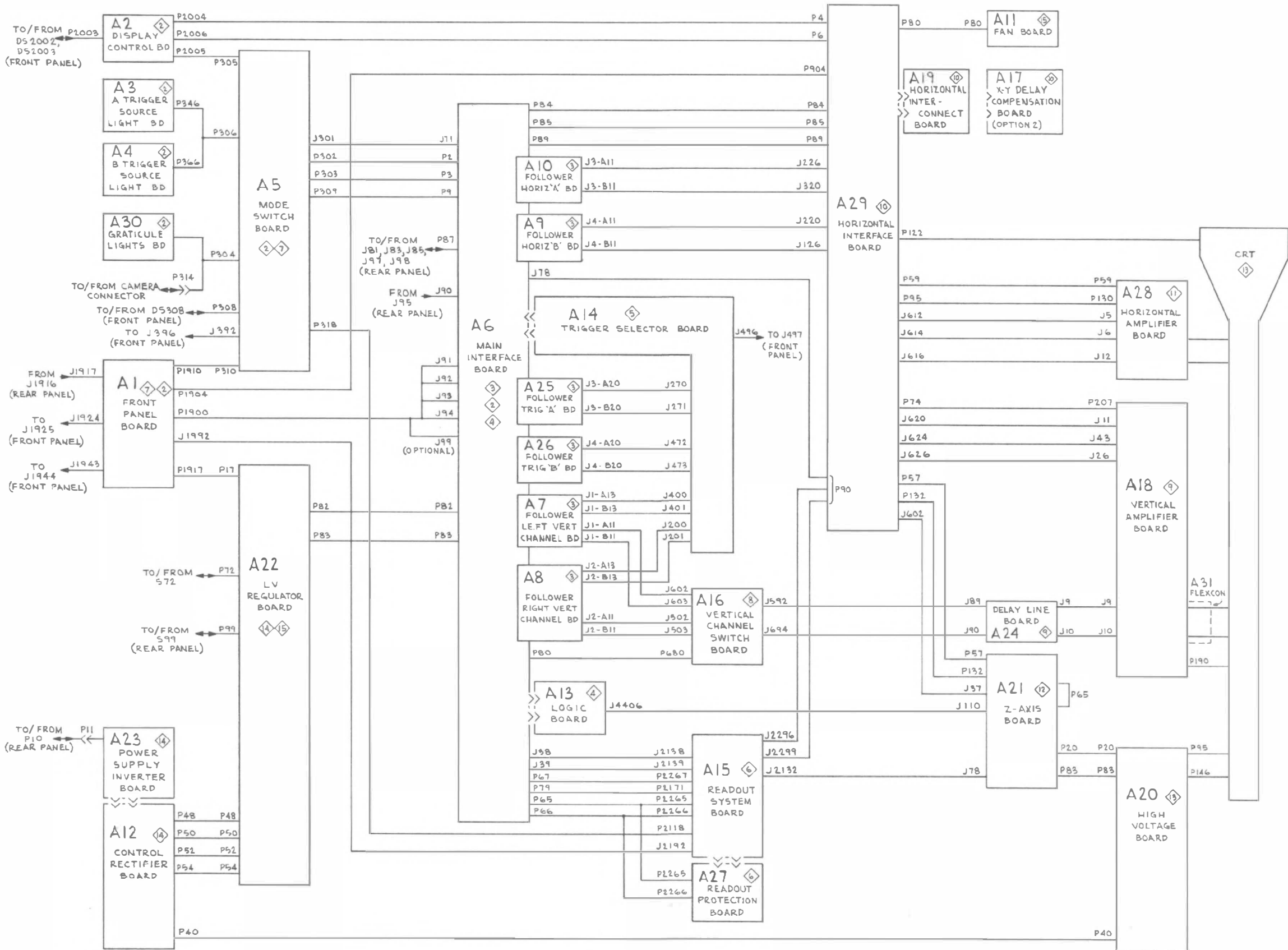

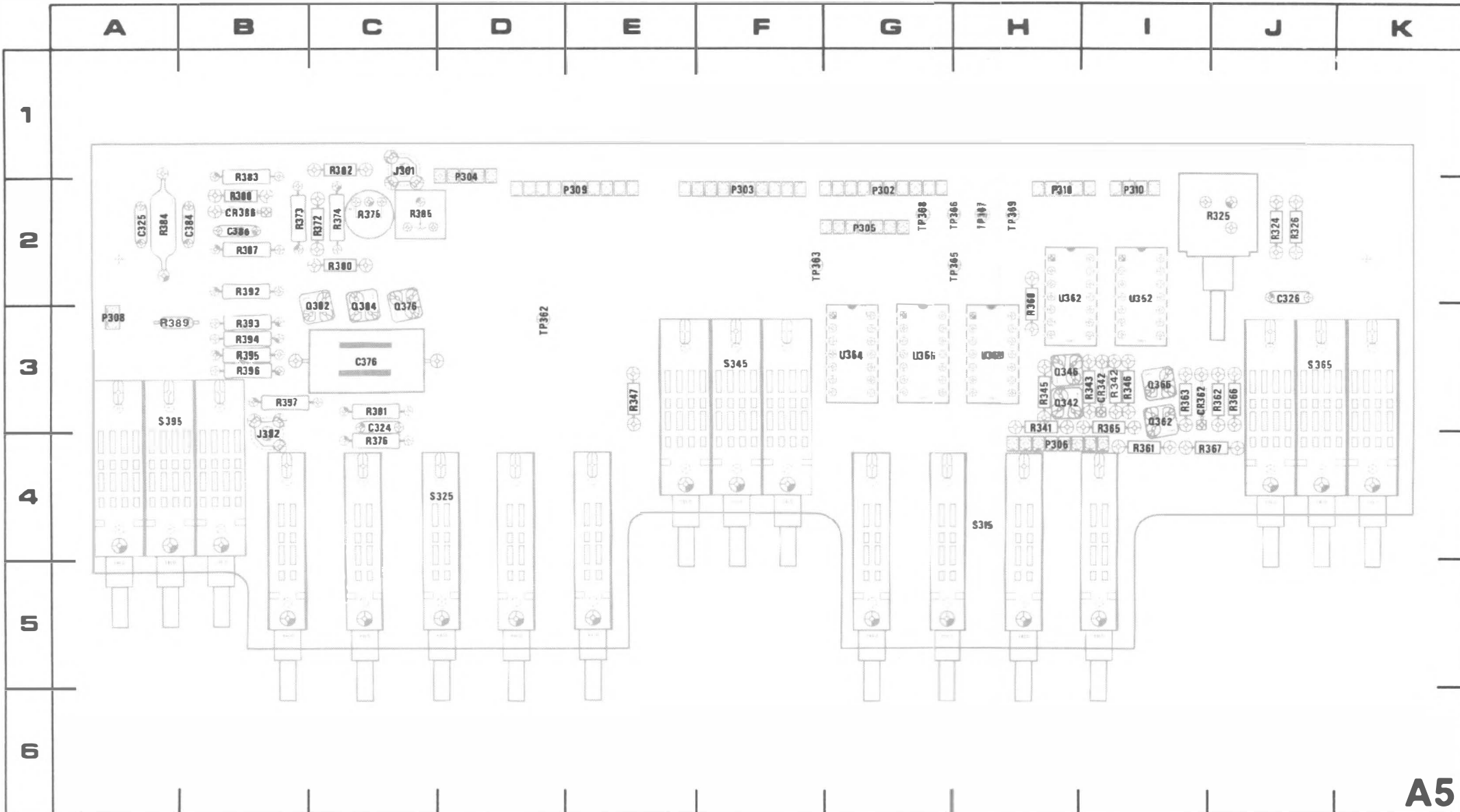

Figure 8-3. A5—Mode Switch circuit board assembly.

A5

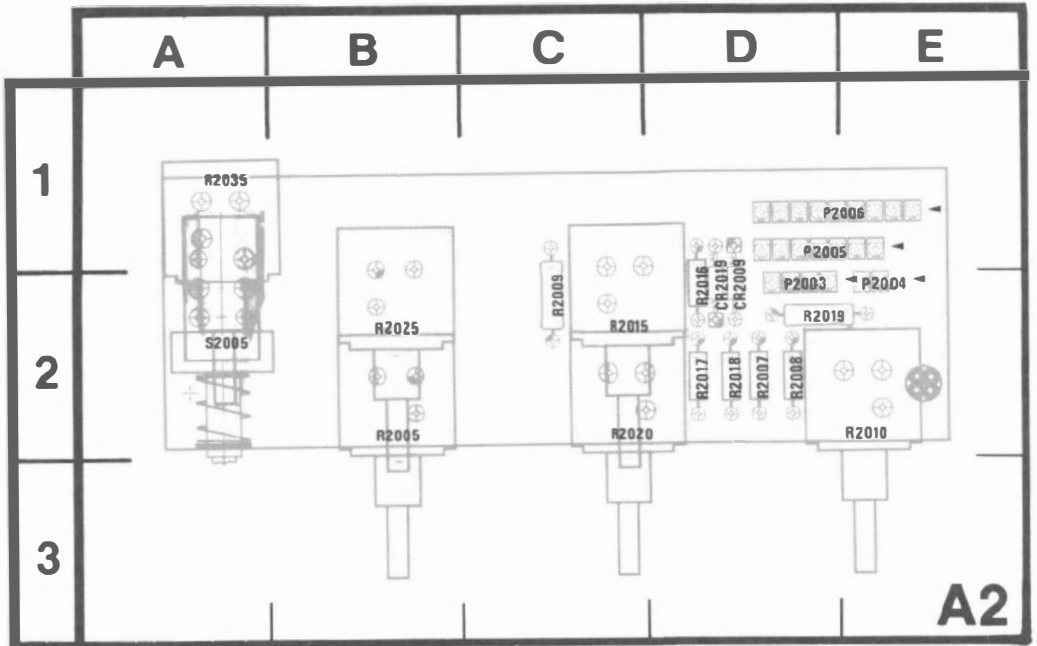
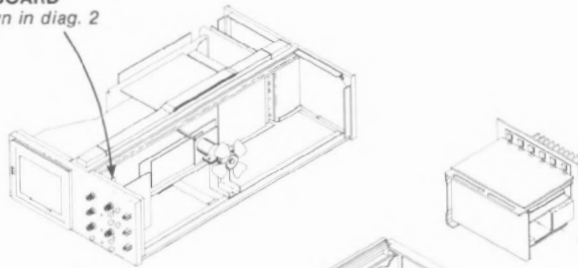

Figure 8-4. A2—Display Control circuit board assembly.

4593-803

**A2
DISPLAY CONTROL
BOARD**
Shown in diag. 2



**A5
MODE SWITCH
BOARD**
*Shown in diags.
2, 7*

MODE SWITCH, DISPLAY CONTROL & CALIBRATOR DIAGRAM

2

ASSEMBLY A1

| CIRCUIT NUMBER | SCHEM LOCATION | BOARD LOCATION | CIRCUIT NUMBER | SCHEM LOCATION | BOARD LOCATION | |
|----------------|----------------|----------------|----------------|----------------|----------------|--|
| P1910 | A4 | B4 | R301 | A3 | B3 | |
| P1917 | A3 | A4 | | | | |

Partial A1 also shown on diagram 7.

ASSEMBLY A2

| CIRCUIT NUMBER | SCHEM LOCATION | BOARD LOCATION | CIRCUIT NUMBER | SCHEM LOCATION | BOARD LOCATION | CIRCUIT NUMBER | SCHEM LOCATION | BOARD LOCATION |
|----------------|----------------|----------------|----------------|----------------|----------------|----------------|----------------|----------------|
| CR2009 | B4 | D2 | R2005 | A5 | B2 | R2019 | B4 | D2 |
| CR2019 | B4 | D2 | R2007 | B5 | D2 | R2020 | B5 | C2 |
| | | | R2008 | B5 | D2 | R2025 | B5 | B2 |
| P2003 | C5 | D2 | R2009 | B4 | C2 | R2035 | B5 | A1 |
| P2004 | C4 | E2 | R2010 | B5 | E2 | | | |
| P2005 | A4 | D1 | R2015 | B5 | C2 | S2005 | A5 | A2 |
| P2005 | B4 | D1 | R2016 | B5 | D2 | | | |
| P2006 | A4 | D1 | R2017 | B5 | D2 | | | |
| | | | R2018 | B5 | D2 | | | |

ASSEMBLY A5

| CIRCUIT NUMBER | SCHEM LOCATION | BOARD LOCATION | CIRCUIT NUMBER | SCHEM LOCATION | BOARD LOCATION | CIRCUIT NUMBER | SCHEM LOCATION | BOARD LOCATION |
|----------------|----------------|----------------|----------------|----------------|----------------|----------------|----------------|----------------|
| C324 | A2 | C3 | Q384 | G4 | C3 | R395 | H3 | B3 |
| C325 | A2 | A2 | | | | R396 | H3 | B3 |
| C326 | A2 | J2 | R324 | C2 | J2 | R397 | H3 | B3 |
| C376 | H4 | C3 | R325 | D2 | I2 | | | |
| C384 | G3 | B2 | R326 | D2 | J2 | S315 | C4 | H4 |
| C386 | G3 | B2 | R341 | D4 | H3 | S325 | D4 | C4 |
| | | | R342 | D4 | I3 | S345 | E4 | F3 |
| CR342 | D4 | I3 | R343 | D4 | I3 | S365 | F4 | J3 |
| CR362 | F4 | I3 | R345 | E4 | H3 | S395 | G2 | A3 |
| CR386 | G3 | B2 | H346 | E4 | I3 | | | |
| | | | R347 | D4 | E3 | TP362 | D2 | D3 |
| J301 | D2 | C1 | R347 | E4 | E3 | TP363 | E2 | F2 |
| J392 | H2 | B4 | R361 | F4 | I4 | TP365 | E3 | G2 |
| | | | R362 | F4 | J3 | TP366 | E2 | G2 |
| P302 | A2 | G2 | R363 | F4 | I3 | TP367 | F2 | H2 |
| P302 | E2 | G2 | R365 | F4 | I3 | TP368 | E2 | G2 |
| P303 | A3 | F2 | R366 | F4 | J3 | TP369 | G2 | H2 |
| P304 | A4 | D1 | R367 | F4 | I4 | | | |
| P305 | A4 | G2 | R368 | F2 | H2 | U352A | E3 | I2 |
| P305 | C4 | G2 | R372 | G4 | C2 | U352C | F3 | I2 |
| P306 | D4 | H4 | R373 | G4 | B2 | U352D | F3 | I2 |
| P306 | F4 | H4 | R374 | G4 | C2 | U362A | F3 | H2 |
| P308 | A4 | A3 | R375 | G4 | C2 | U362B | E2 | H2 |
| P309 | C2 | F2 | R376 | H4 | C4 | U362C | E3 | H2 |
| P309 | D2 | F2 | R380 | G4 | C2 | U364A | E3 | G3 |
| P310 | A4 | I2 | R381 | H4 | C3 | U364B | E3 | G3 |
| P318 | C3 | H2 | R382 | G3 | C1 | U364C | F3 | G3 |
| | | | R383 | G3 | B1 | U364D | E3 | G3 |
| Q342 | D4 | H3 | R384 | G3 | A2 | U366B | E2 | G3 |
| Q346 | E4 | H3 | R385 | G3 | C2 | U366C | E2 | G3 |
| Q362 | F4 | I3 | R386 | G3 | B2 | U366C | G2 | G3 |
| Q366 | F4 | I3 | R387 | G3 | B2 | U366D | F2 | G3 |
| Q376 | G4 | C3 | R392 | G3 | B2 | U368A | F2 | H3 |
| Q382 | G4 | C3 | R393 | G3 | B3 | U368B | E2 | H3 |
| Q384 | G3 | C3 | R394 | G3 | B3 | U368C | F2 | H3 |

Partial A5 also shown on diagrams 4 and 7.

ASSEMBLY A6

| CIRCUIT NUMBER | SCHEM LOCATION | BOARD LOCATION | CIRCUIT NUMBER | SCHEM LOCATION | BOARD LOCATION | CIRCUIT NUMBER | SCHEM LOCATION | BOARD LOCATION |
|----------------|----------------|----------------|----------------|----------------|----------------|----------------|----------------|----------------|
| J71 | D2 | A5 | P2 | E2 | A5 | P9 | D2 | A7 |
| P2 | A2 | A5 | P3 | A3 | A3 | P89 | A1 | A2 |
| | | | P9 | C2 | A7 | | | |

Partial A6 also shown on diagram 3.

CHASSIS MOUNTED PARTS

| CIRCUIT NUMBER | SCHEM LOCATION | BOARD LOCATION | CIRCUIT NUMBER | SCHEM LOCATION | BOARD LOCATION | CIRCUIT NUMBER | SCHEM LOCATION | BOARD LOCATION |
|----------------|----------------|----------------|----------------|----------------|----------------|----------------|----------------|----------------|
| DS304 | A5 | CHASSIS | DS362 | F4 | CHASSIS | P314 | A4 | CHASSIS |
| DS305 | A5 | CHASSIS | DS365 | F4 | CHASSIS | P346 | D4 | CHASSIS |
| DS306 | A5 | CHASSIS | DS366 | F4 | CHASSIS | P366 | F4 | CHASSIS |
| DS308 | A4 | CHASSIS | DS2002 | C5 | CHASSIS | | | |
| DS342 | D4 | CHASSIS | DS2003 | C5 | CHASSIS | | | |
| DS345 | E4 | CHASSIS | | | | | | |
| DS346 | E4 | CHASSIS | J396 | H2 | CHASSIS | | | |

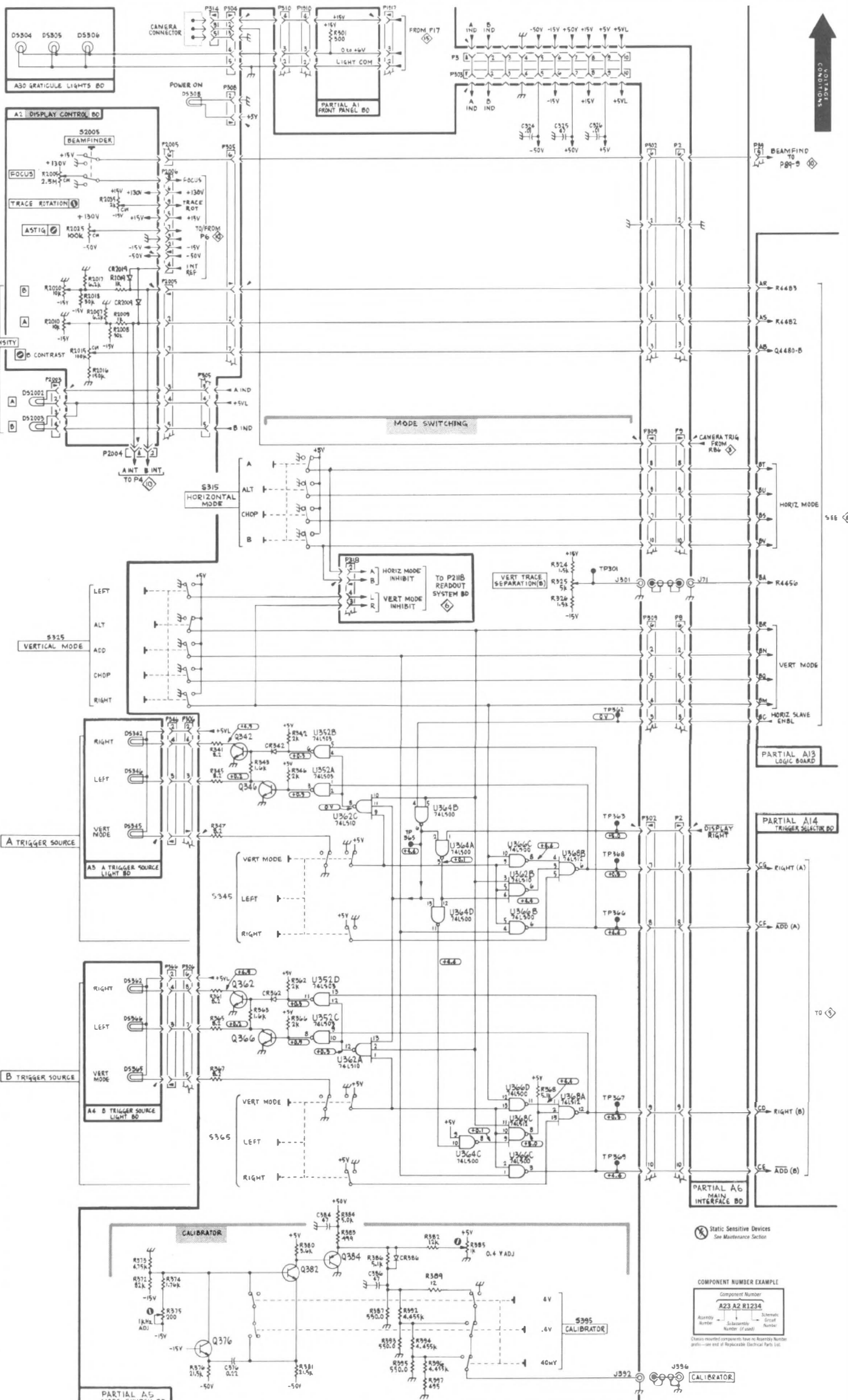

Static Sensitive Devices
See Maintenance Section

COMPONENT NUMBER EXAMPLE

| | | | |
|------------------|------------------------------|--------------------------|--|
| Component Number | | | |
| A23 | A2 | R1234 | |
| Assembly Number | Subassembly Number (if used) | Schematic Diagram Number | |

Caution: mounted components have no Assembly Number prefix—see end of Replaceable Electrical Parts List.

A
B
C
D
E
F
G

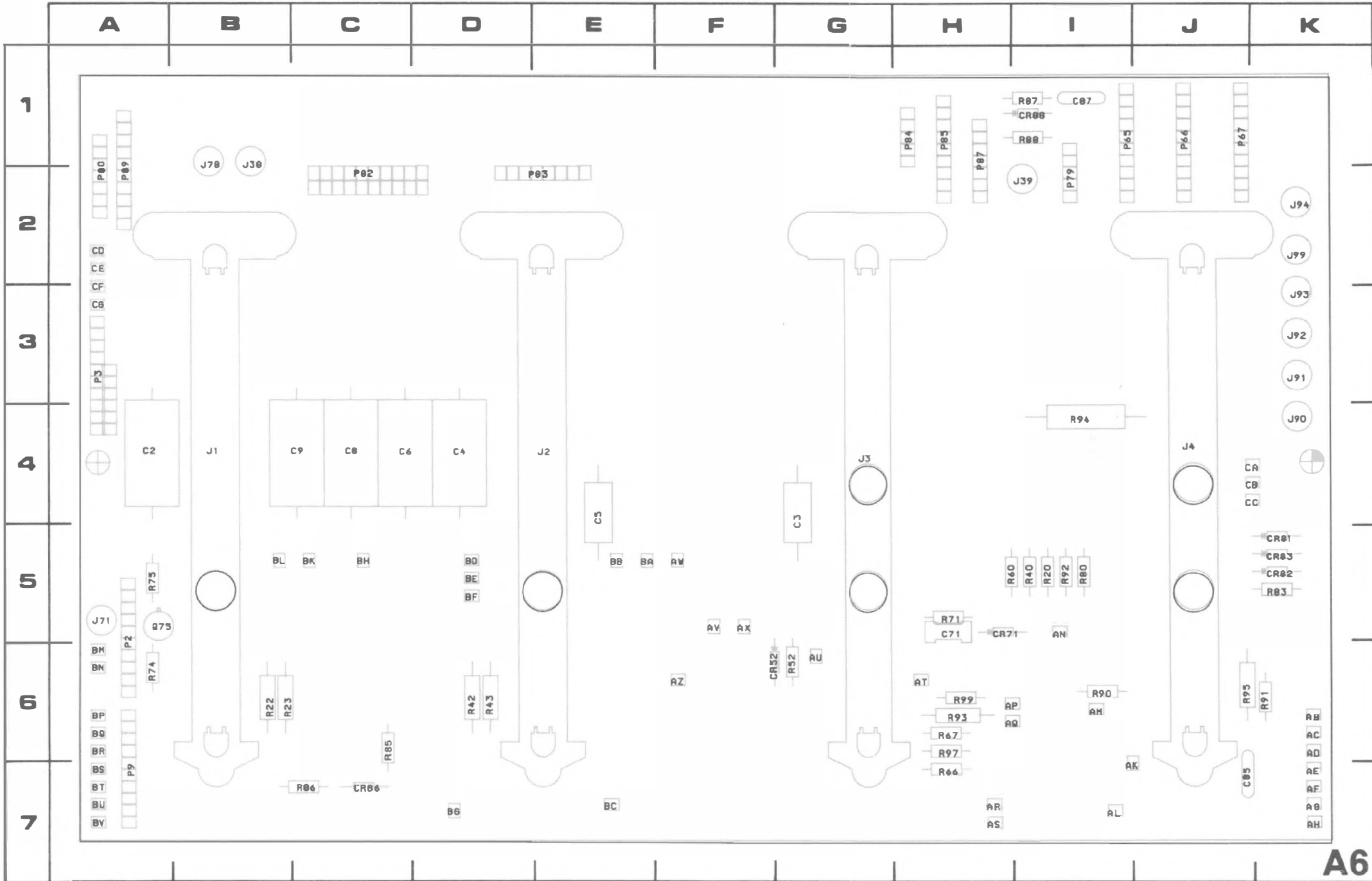

A6

Figure 8-5. A6—Main Interface circuit board assembly.

MAIN INTERFACE DIAGRAM 3

ASSEMBLY A6

| CIRCUIT NUMBER | SCHEM LOCATION | BOARD LOCATION | CIRCUIT NUMBER | SCHEM LOCATION | BOARD LOCATION | CIRCUIT NUMBER | SCHEM LOCATION | BOARD LOCATION |
|----------------|----------------|----------------|----------------|----------------|----------------|----------------|----------------|----------------|
| C2 | A3 | A4 | J78 | G3 | B1 | R23 | B4 | B6 |
| C3 | A3 | G4 | J90 | A4 | K4 | R40 | B4 | I5 |
| C4 | A3 | D4 | J91 | G4 | K3 | R42 | D4 | D6 |
| C5 | A3 | E4 | J92 | G4 | K3 | R43 | D4 | D6 |
| C6 | A3 | C4 | J93 | G4 | K3 | R52 | D4 | G6 |
| C8 | A3 | C4 | J94 | G4 | K2 | R60 | B5 | I5 |
| C9 | A3 | C4 | J99 | G4 | K2 | R66 | E4 | H7 |
| C71 | E3 | H5 | | | | R67 | E4 | H6 |
| CB5 | F3 | J7 | P2 | B5 | A5 | R71 | E3 | H5 |
| CB7 | F3 | I1 | P3 | D5 | A3 | R74 | B5 | A6 |
| | | | P9 | C5 | A7 | R75 | B5 | A5 |
| CR52 | D4 | G6 | P65 | C1 | I1 | R83 | F2 | K5 |
| CR71 | E3 | H5 | P66 | E1 | J1 | R85 | F3 | C6 |
| CR81 | F3 | K5 | P67 | D1 | J1 | R86 | G3 | C6 |
| CR82 | F3 | K5 | P79 | E5 | I2 | R87 | F3 | I1 |
| CR83 | F3 | K5 | P80 | A1 | A2 | R88 | G3 | I1 |
| CR86 | F3 | C6 | P82 | A3 | C2 | R90 | F4 | I6 |
| CR88 | F3 | I1 | P84 | G5 | H1 | R91 | G4 | K6 |
| | | | P85 | A4 | H1 | R92 | B4 | I5 |
| J1 | B1 | B4 | P87 | G3 | H1 | R93 | G4 | H6 |
| J2 | C1 | E4 | P89 | A2 | A2 | R94 | A4 | I4 |
| J3 | D1 | G4 | | | | R95 | G4 | J6 |
| J4 | F1 | J4 | Q75 | B5 | A5 | R97 | G4 | H6 |
| J38 | A1 | B1 | | | | R99 | G4 | H6 |
| J39 | G4 | I2 | R20 | B4 | I5 | | | |
| J71 | G5 | A5 | R22 | B4 | B6 | | | |

Partial A6 also shown on diagram 2.

CHASSIS MOUNTED PARTS

| CIRCUIT NUMBER | SCHEM LOCATION | BOARD LOCATION | CIRCUIT NUMBER | SCHEM LOCATION | BOARD LOCATION | CIRCUIT NUMBER | SCHEM LOCATION | BOARD LOCATION |
|----------------|----------------|----------------|----------------|----------------|----------------|----------------|----------------|----------------|
| A7 | B3 | CHASSIS | A14 | C5 | CHASSIS | J81 | G3 | CHASSIS |
| A8 | C3 | CHASSIS | A25 | D2 | CHASSIS | J85 | G3 | CHASSIS |
| A9 | F3 | CHASSIS | A26 | F2 | CHASSIS | J95 | A4 | CHASSIS |
| A10 | D3 | CHASSIS | | | | | | |

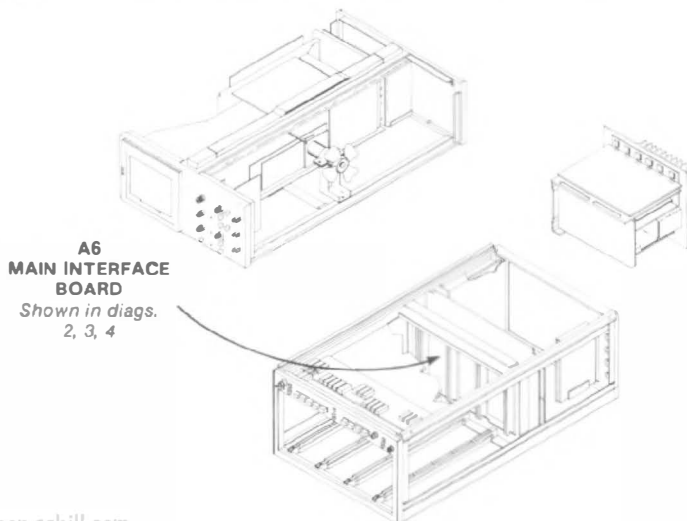

A

B

C

D

E

F

G

1

2

3

4

5

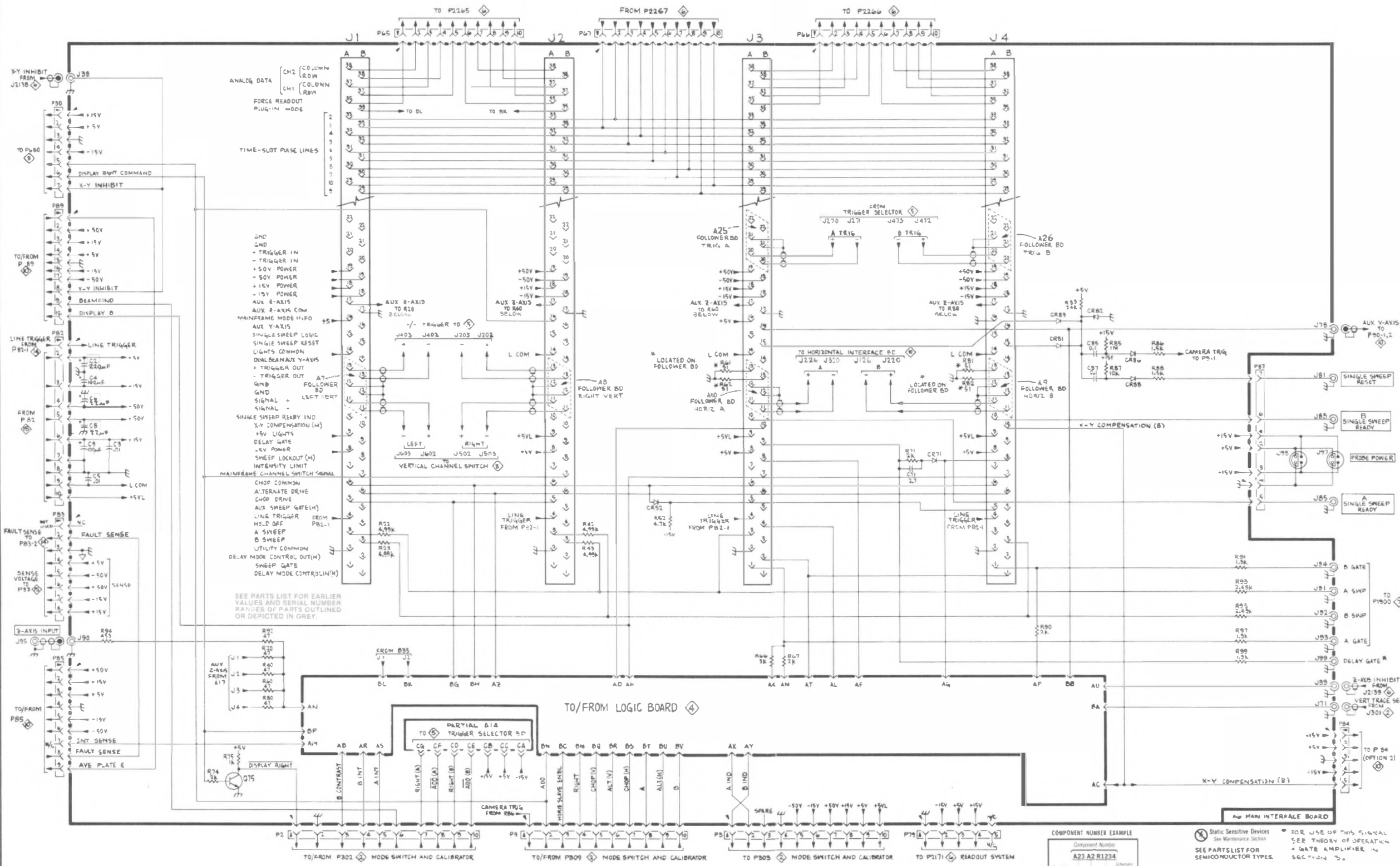

COMPONENT NUMBER EXAMPLE

| | | |
|------------------|--------------------|-------------------------|
| Component Number | | |
| A23 | A2 | R1234 |
| Assembly Number | Subassembly Number | Interchange Unit Number |
| Number of units | | |

Obtain related components from the Assembly Number page - see end of Reproducible Electrical Parts List.

Static Sensitive Devices
See Maintenance Section
SEE PARTS LIST FOR SEMICONDUCTOR TYPES.

FOR USE OF THIS SIGNAL
SEE THEORY OF OPERATION
GATE AMPLIFIER IN
SGC-1-2-4-5.

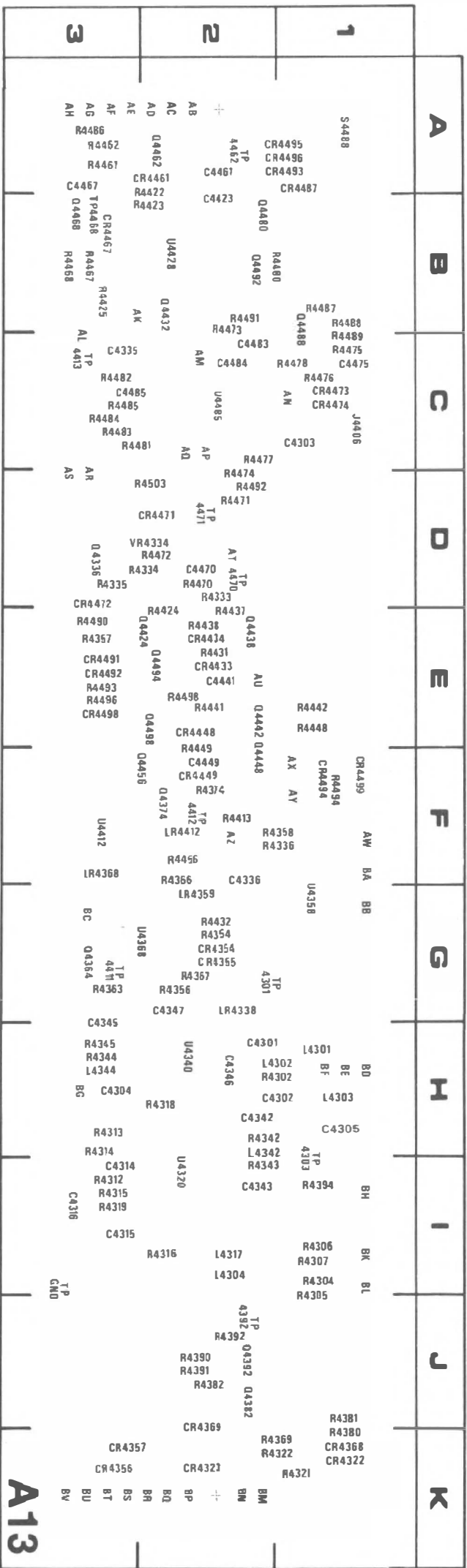
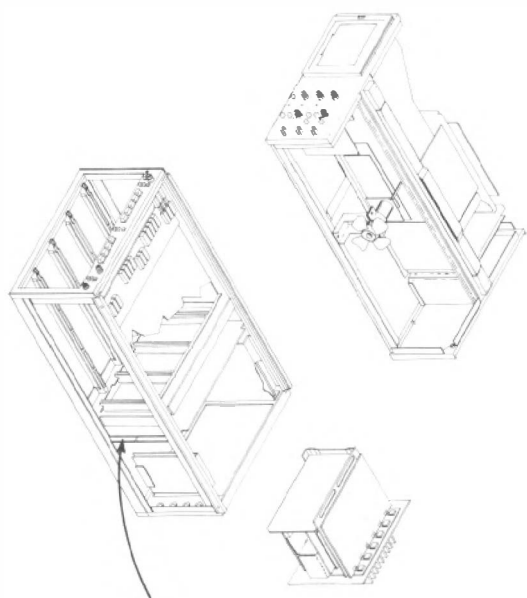

Figure 8-6. A13—Logic circuit board assembly.



A13
LOGIC BOARD
Shown in diag.
2, 4

LOGIC DIAGRAM

4

ASSEMBLY A5

| CIRCUIT NUMBER | SCHEM LOCATION | BOARD LOCATION | CIRCUIT NUMBER | SCHEM LOCATION | BOARD LOCATION | CIRCUIT NUMBER | SCHEM LOCATION | BOARD LOCATION |
|----------------|----------------|----------------|----------------|----------------|----------------|----------------|----------------|----------------|
| R324 | H3 | J2 | R325 | H3 | I2 | R326 | H3 | J2 |

Partial A5 also shown on diagrams 2 and 7

ASSEMBLY A13

| CIRCUIT NUMBER | SCHEM LOCATION | BOARD LOCATION | CIRCUIT NUMBER | SCHEM LOCATION | BOARD LOCATION | CIRCUIT NUMBER | SCHEM LOCATION | BOARD LOCATION | CIRCUIT NUMBER | SCHEM LOCATION | BOARD LOCATION |
|----------------|----------------|----------------|----------------|----------------|----------------|----------------|----------------|----------------|----------------|----------------|----------------|
| C4301 | A3 | H2 | CR4493 | E4 | A1 | R4315 | B2 | I3 | R4470 | C4 | D2 |
| C4302 | A2 | H1 | CR4494 | G4 | F1 | R4315 | B3 | I3 | R4471 | C4 | D2 |
| C4303 | A2 | C1 | CR4495 | E4 | A1 | R4316 | A3 | I2 | R4472 | C4 | D2 |
| C4303 | A4 | C1 | CR4496 | E4 | A1 | R4318 | B2 | H2 | R4473 | A5 | B2 |
| C4304 | A4 | H3 | CR4498 | E4 | E3 | R4319 | B2 | I3 | R4474 | A5 | C2 |
| C4304 | B4 | H3 | CR4499 | G4 | F1 | R4321 | B1 | K1 | R4475 | C5 | C1 |
| C4305 | A4 | H1 | | | | R4322 | B1 | K1 | R4476 | C5 | C1 |
| C4314 | B2 | I3 | J4406 | G4 | C1 | R4333 | C3 | D2 | R4477 | D4 | C2 |
| C4315 | B3 | I3 | | | | R4334 | C3 | D2 | R4478 | E5 | C1 |
| C4316 | A3 | I3 | L4301 | A3 | H1 | R4335 | C3 | D3 | R4480 | E5 | B1 |
| C4335 | C3 | C3 | L4302 | A3 | H1 | R4336 | C2 | F1 | R4481 | E5 | C3 |
| C4336 | C2 | F2 | L4303 | A4 | H1 | R4342 | C2 | H2 | R4482 | F5 | C3 |
| C4342 | B2 | H2 | L4304 | A4 | I2 | R4343 | C2 | I2 | R4483 | F5 | C3 |
| C4343 | C2 | I2 | L4317 | A3 | I2 | R4344 | C2 | H3 | R4484 | F5 | C3 |
| C4345 | C2 | H3 | L4342 | C2 | H2 | R4345 | C2 | H3 | R4485 | E4 | C3 |
| C4346 | B2 | H2 | L4344 | C2 | H2 | R4354 | D2 | G2 | R4486 | D3 | A3 |
| C4347 | B2 | G2 | | | | R4356 | D2 | G2 | R4487 | D3 | B1 |
| C4423 | D3 | B2 | LR4338 | C2 | G2 | R4357 | C2 | E3 | R4488 | E4 | B1 |
| C4441 | E3 | E2 | LR4359 | D2 | G2 | R4358 | D2 | F1 | R4489 | E3 | B1 |
| C4449 | F3 | F2 | LR4368 | E2 | F3 | R4363 | D2 | G3 | R4490 | D4 | E3 |
| C4461 | E3 | A2 | LR4412 | F2 | F2 | R4366 | E2 | F2 | R4491 | E3 | B2 |
| C4467 | E3 | A3 | | | | R4367 | E2 | G2 | R4492 | E3 | D2 |
| C4470 | C4 | D2 | Q4336 | C3 | D3 | R4369 | E1 | K1 | R4493 | E4 | E3 |
| C4475 | B5 | C1 | Q4364 | E2 | G3 | R4374 | E1 | F2 | R4494 | F4 | F1 |
| C4483 | E5 | C2 | Q4374 | F1 | F2 | R4380 | F1 | K1 | R4496 | E4 | E3 |
| C4484 | E4 | C2 | Q4382 | F1 | J2 | R4381 | F1 | J1 | R4498 | G4 | E2 |
| C4485 | E4 | C3 | Q4392 | F1 | J2 | R4382 | F1 | J2 | | | |
| | | | Q4424 | C2 | E2 | R4390 | F1 | J2 | S4488 | D4 | A1 |
| CR4322 | C1 | K1 | Q4432 | E3 | B2 | R4391 | F1 | J2 | | | |
| CR4323 | C1 | K2 | Q4438 | E3 | E2 | R4392 | F1 | J2 | TP4301 | A3 | G2 |
| CR4354 | D2 | G2 | Q4442 | F3 | E2 | R4394 | G2 | I1 | TP4303 | A4 | H1 |
| CR4355 | D2 | G2 | Q4448 | F3 | E2 | R4413 | F2 | F2 | TP4392 | G1 | J2 |
| CR4356 | C2 | K3 | Q4456 | G3 | F2 | R4422 | C3 | A2 | TP4411 | G2 | G3 |
| CR4357 | C2 | K3 | Q4462 | F3 | A2 | R4423 | D3 | B2 | TP4412 | G2 | F2 |
| CR4368 | E1 | K1 | Q4468 | F3 | B3 | R4424 | D2 | E2 | TP4413 | G3 | C3 |
| CR4369 | E1 | J2 | Q4480 | E5 | B2 | R4425 | D3 | B3 | TP4462 | E3 | A2 |
| CR4433 | F3 | E2 | Q4488 | E3 | B1 | R4431 | F3 | E2 | TP4468 | E3 | B3 |
| CR4434 | E3 | E2 | Q4492 | E3 | B2 | R4432 | E2 | G2 | TP4470 | C4 | D2 |
| CR4448 | F3 | E2 | Q4494 | F4 | E2 | R4437 | E3 | E2 | TP4471 | D4 | D2 |
| CR4449 | F3 | F2 | Q4498 | G4 | E2 | R4438 | E3 | E2 | | | |
| CR4461 | E3 | A2 | | | | R4441 | F3 | E2 | U4320 | B2 | I2 |
| CR4467 | E3 | B3 | R4302 | A2 | H1 | R4442 | F3 | E1 | U4340 | C2 | H2 |
| CR4471 | C4 | D2 | R4304 | A2 | I1 | R4448 | F3 | E1 | U4358 | D2 | G1 |
| CR4472 | C4 | D3 | R4305 | A2 | J1 | R4449 | F3 | E2 | U4368 | E2 | G2 |
| CR4473 | B5 | C1 | R4306 | A2 | I1 | R4456 | G3 | F2 | U4412 | F2 | F3 |
| CR4474 | B5 | C1 | R4307 | A2 | I1 | R4461 | E3 | A3 | U4428 | D3 | B2 |
| CR4487 | D4 | A1 | R4312 | B3 | I3 | R4462 | F3 | A3 | U4485 | E4 | C2 |
| CR4491 | E4 | E3 | R4313 | B3 | H3 | R4467 | E3 | B3 | | | |
| CR4492 | E4 | E3 | R4314 | B3 | H3 | R4468 | F3 | B3 | VR4334 | C3 | D2 |

CHASSIS MOUNTED PARTS

| CIRCUIT NUMBER | SCHEM LOCATION | BOARD LOCATION | CIRCUIT NUMBER | SCHEM LOCATION | BOARD LOCATION |
|----------------|----------------|----------------|----------------|----------------|----------------|
| DS2002 | G4 | CHASSIS | DS2003 | G4 | CHASSIS |

A

B

C

D

E

F

G

1

2

3

4

5

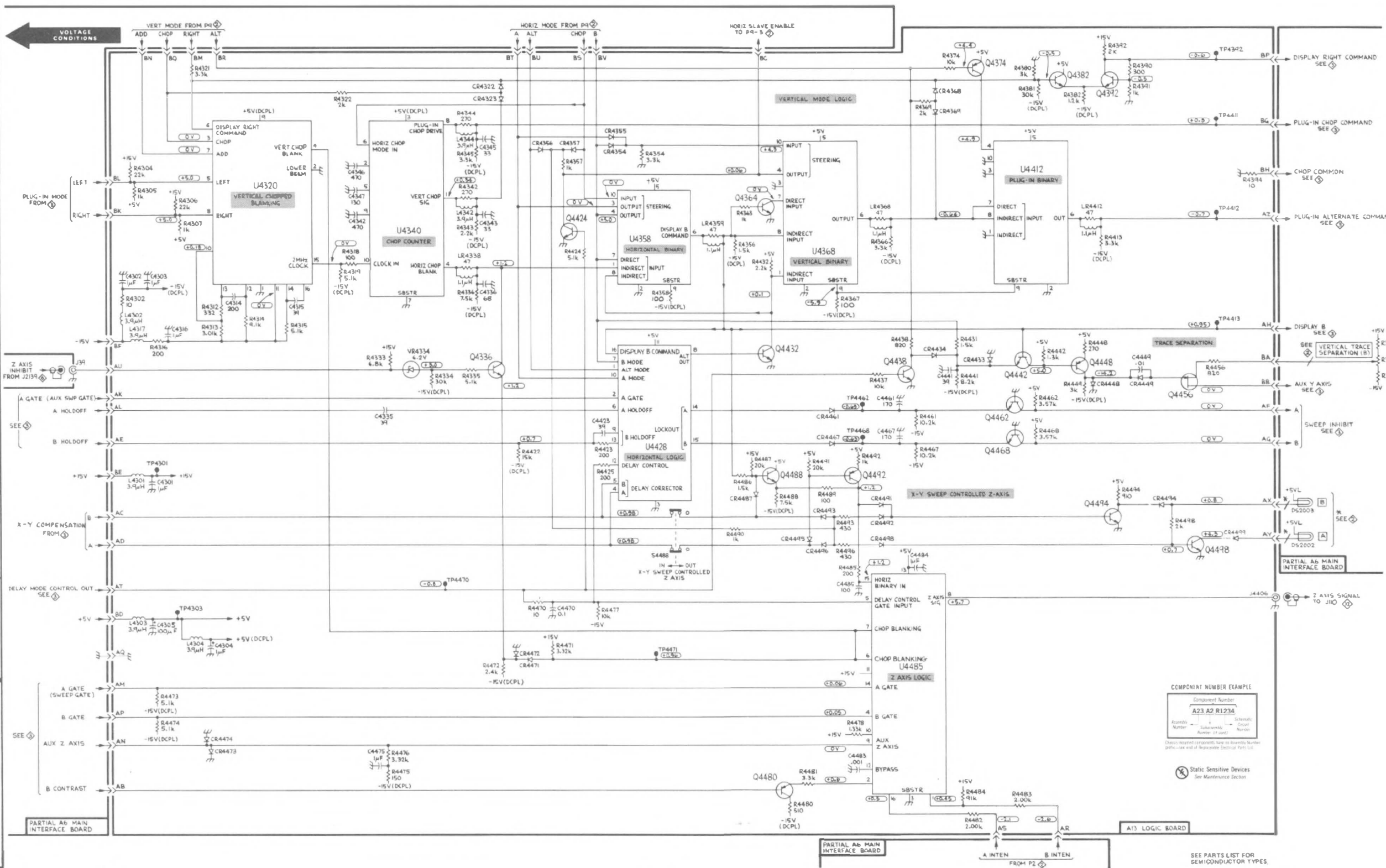

COMPONENT NUMBER EXAMPLE

| | | | |
|------------------|--------------------|--------------|-------------|
| Component Number | | | |
| A23 | A2 | R1234 | |
| Assembly Number | Subassembly Number | Group Number | Part Number |

Discontinued components have Assembly Number prefix - see end of Reproducible Electrical Parts List

Static Sensitive Devices
See Maintenance Section

SEE PARTS LIST FOR SEMICONDUCTOR TYPES

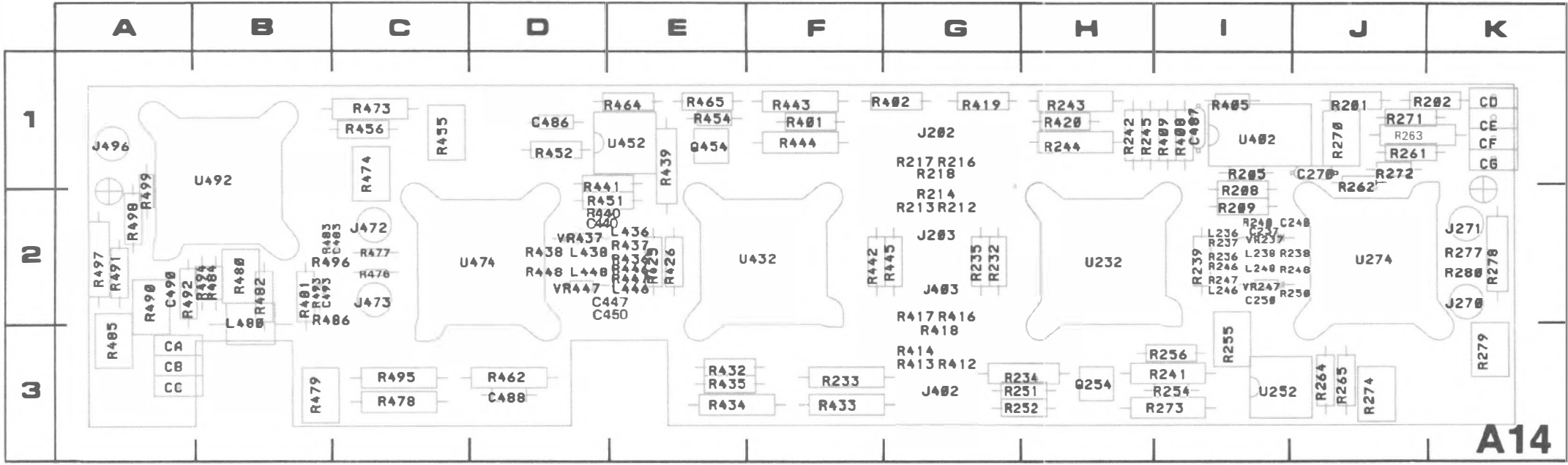
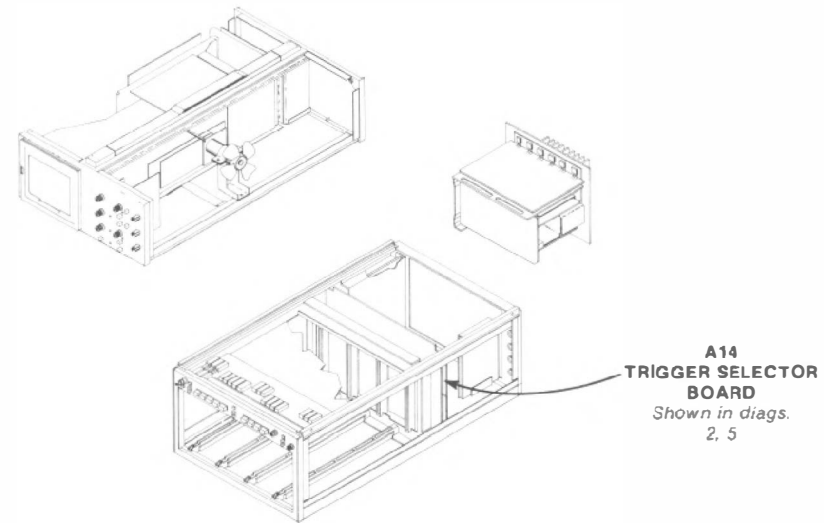

Figure 8-7. A14—Trigger Selector circuit board assembly.

4593-806



TRIGGER SELECTOR DIAGRAM

5

ASSEMBLY A14

| CIRCUIT NUMBER | SCHEM LOCATION | BOARD LOCATION | CIRCUIT NUMBER | SCHEM LOCATION | BOARD LOCATION | CIRCUIT NUMBER | SCHEM LOCATION | BOARD LOCATION |
|----------------|----------------|----------------|----------------|----------------|----------------|----------------|----------------|----------------|
| C237 | A3 | I2 | R240 | A3 | I2 | R444 | E4 | R1 |
| C240 | A3 | J2 | R241 | B3 | I3 | R445 | E4 | G2 |
| C250 | C3 | I2 | R242 | C4 | H1 | R446 | E3 | E2 |
| C270 | B3 | J1 | R243 | C4 | H1 | R447 | E3 | E2 |
| C440 | E3 | E2 | R244 | C4 | H1 | R448 | E3 | D2 |
| C447 | D3 | D3 | R245 | C4 | H1 | R451 | E3 | D2 |
| C450 | D3 | D3 | R246 | B3 | I2 | R452 | E3 | D1 |
| C483 | F1 | C2 | R247 | B3 | I2 | R454 | E3 | E1 |
| C486 | F5 | D1 | R248 | B3 | J2 | R455 | E3 | C1 |
| C487 | F5 | I1 | R250 | C3 | J2 | R456 | E3 | C1 |
| C488 | F5 | D3 | R251 | B3 | G3 | R462 | E3 | D3 |
| C490 | G2 | A2 | R252 | B3 | G3 | R464 | F1 | E1 |
| C493 | G2 | B2 | R254 | B3 | I3 | R465 | F1 | E1 |
| | | | R255 | B3 | I3 | R473 | D2 | C1 |
| J202 | C5 | G1 | R256 | B3 | I3 | R474 | D2 | C1 |
| J203 | C5 | G2 | R261 | B3 | J1 | R476 | E2 | C2 |
| J270 | C1 | K2 | R262 | B3 | J2 | R477 | D2 | C2 |
| J271 | A1 | K2 | R263 | B3 | J1 | R47B | D1 | C3 |
| J402 | D5 | G3 | R264 | C2 | J3 | R479 | D1 | B3 |
| J403 | D5 | G2 | R265 | C2 | J3 | R480 | F3 | B2 |
| J472 | D1 | C2 | R270 | B3 | J1 | R481 | F1 | B2 |
| J473 | E1 | C2 | R271 | B3 | J1 | R482 | F1 | B2 |
| J496 | G1 | A1 | R272 | B3 | J1 | R483 | F1 | B2 |
| | | | R273 | A2 | I3 | R484 | F1 | B2 |
| L236 | B3 | I2 | R274 | A2 | J3 | R485 | G2 | A3 |
| L238 | B3 | I2 | R277 | B2 | K2 | R486 | G3 | B2 |
| L246 | B3 | I2 | R278 | B2 | K2 | R490 | G2 | A2 |
| L248 | B3 | I2 | R279 | B1 | K3 | R491 | G2 | A2 |
| L436 | D3 | E2 | R280 | B2 | K2 | R492 | G2 | A2 |
| L438 | D3 | D2 | R401 | D5 | R1 | R493 | G2 | B2 |
| L446 | E3 | E2 | R402 | E5 | G1 | R494 | G2 | B2 |
| L448 | E3 | D2 | R405 | E5 | I1 | R495 | G2 | C3 |
| L480 | G3 | B2 | R408 | E5 | I1 | R496 | G3 | B2 |
| | | | R409 | E5 | I1 | R497 | G1 | A2 |
| Q254 | B4 | H3 | R412 | D4 | G3 | R498 | G1 | A2 |
| Q454 | E4 | E1 | R413 | D4 | G3 | R499 | F1 | A2 |
| | | | R414 | D4 | G3 | | | |
| R201 | B5 | J1 | R416 | D4 | G2 | U232 | A4 | H2 |
| R202 | B5 | K1 | R417 | D4 | G2 | U252A | B3 | I3 |
| R205 | B5 | I1 | R418 | D4 | G3 | U252B | C2 | I3 |
| R208 | B5 | I2 | R419 | D4 | G1 | U274 | A2 | J2 |
| R209 | B5 | I2 | R420 | D4 | H1 | U402A | B5 | I1 |
| R212 | C5 | G2 | R425 | E4 | E2 | U402B | B5 | I1 |
| R213 | C5 | G2 | R426 | E4 | E2 | U402C | E5 | I1 |
| R214 | C5 | G2 | R432 | D4 | E3 | U402D | E5 | I1 |
| R216 | C5 | G1 | R433 | D4 | R3 | U432 | D4 | R2 |
| R217 | C5 | G1 | R434 | D4 | E3 | U452A | E3 | E1 |
| R218 | C5 | G1 | R435 | D4 | E3 | U452B | F1 | E1 |
| R232 | A4 | G2 | R436 | D3 | E2 | U474 | D2 | C2 |
| R233 | A4 | R3 | R437 | D3 | E2 | U492 | F1 | B1 |
| R234 | A4 | G3 | R438 | D3 | D2 | | | |
| R235 | A4 | G2 | R439 | D3 | E1 | VR237 | B3 | I2 |
| R236 | B3 | I2 | R440 | E3 | E2 | VR247 | B3 | I2 |
| R237 | B3 | I2 | R441 | D3 | D2 | VR437 | D3 | D2 |
| R238 | B3 | J2 | R442 | E4 | R2 | VR447 | E3 | D2 |
| R239 | B3 | I2 | R443 | R4 | R1 | | | |

CHASSIS MOUNTED PARTS

| CIRCUIT NUMBER | SCHEM LOCATION | BOARD LOCATION | | | |
|----------------|----------------|----------------|--|--|--|
| J497 | G1 | CHASSIS | | | |

VOLTAGE CONDITIONS

The voltages shown were obtained with the 7904A front panel variable controls at midrange except INTENSITY control is set fully counterclockwise: READOUT INTENSITY, OFF; VERTICAL MODE, LEFT; TRIGGER SOURCE, VERT MODE; HORIZONTAL MODE, B. No plug-in units were installed.

Voltage Conditions. The voltages shown on the diagram were obtained using a digital multimeter with a 10 M Ω input impedance (TEKTRONIX DM 501A Digital Multimeter or TEKTRONIX 7D13A Digital Multimeter used with a readout-equipped 7000-series Oscilloscope).

VOLTAGE CONDITIONS

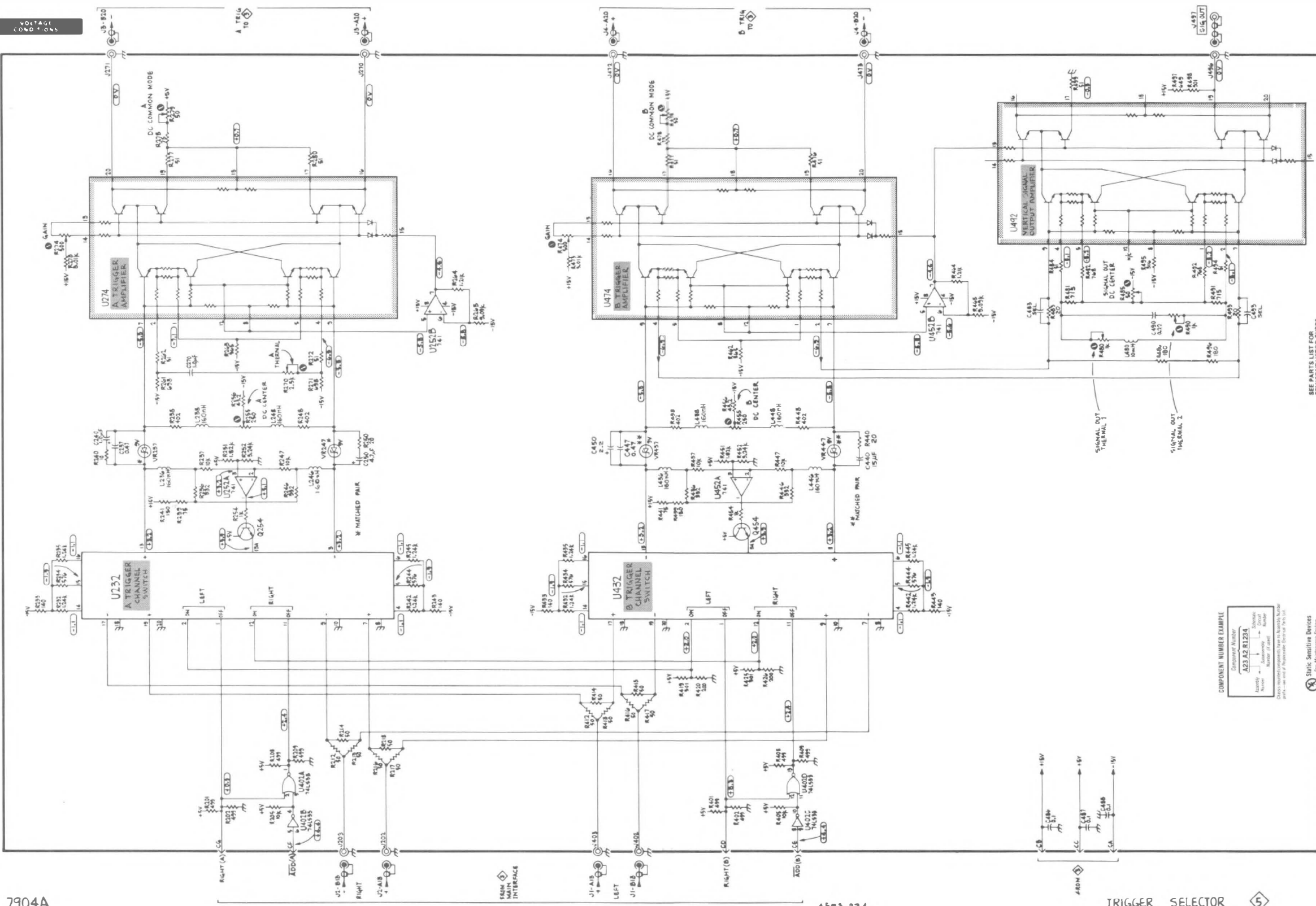

COMPONENT NUMBER EXAMPLE

| | |
|------------------|--------------|
| Component Number | A23 A2 0128A |
| Assembly | 1 |
| Quantity | 1 |
| Number of units | 1 |

Check required components from the Assembly Number
 parts—see end of Representative Circuit Parts List.

Static Sensitive Devices
 See Maintenance Section

SEE PARTS LIST FOR SEMICONDUCTOR TYPES

A14 TRIGGER SELECTOR MD

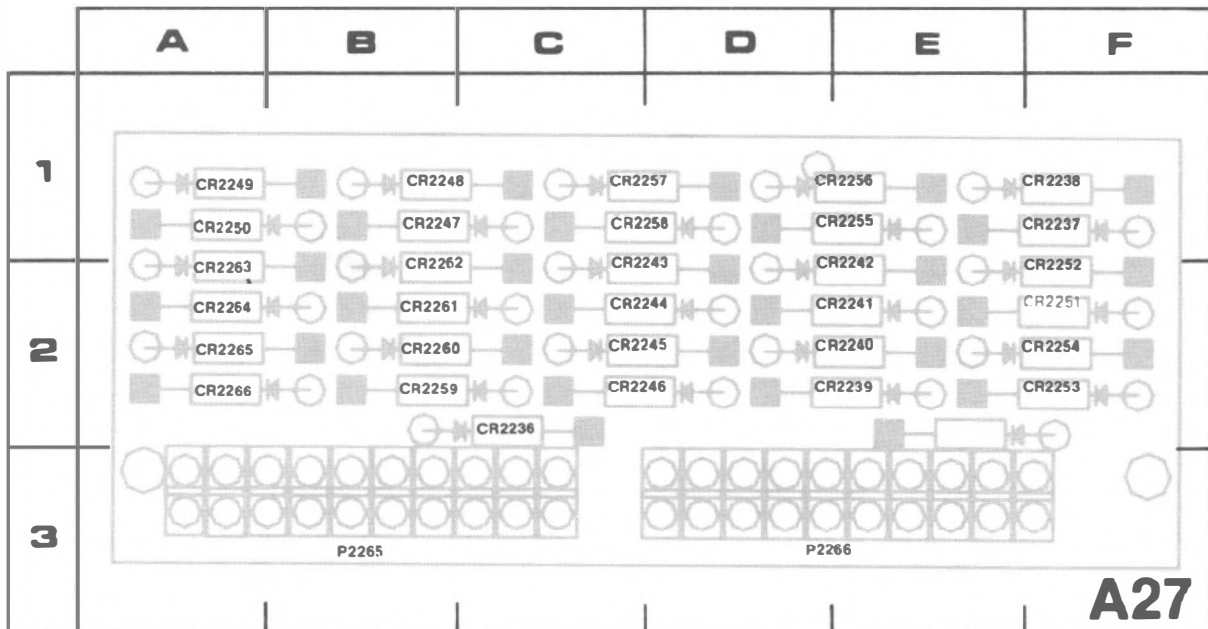

4593-808

Figure 8-8B. A27—Readout Protection circuit board assembly

REV JUL 1988

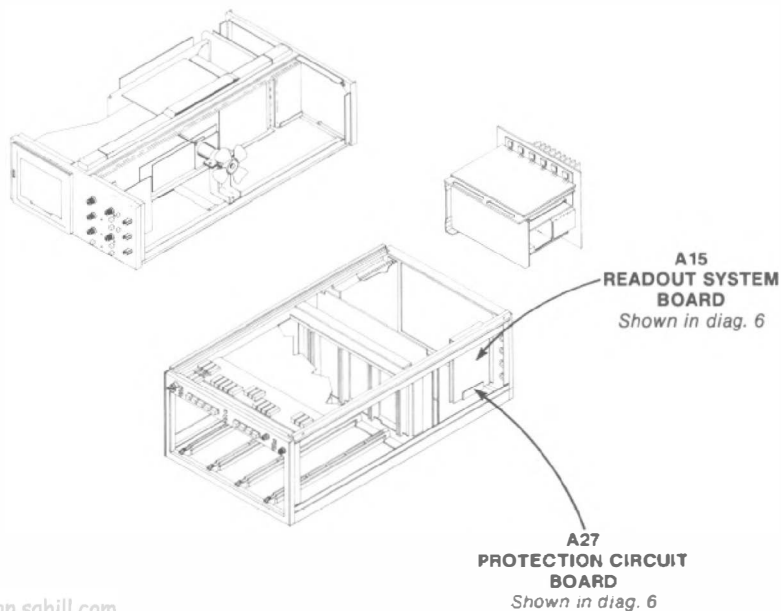

READOUT SYSTEM DIAGRAM

6

ASSEMBLY A15 (SN B031767-Up)

| CIRCUIT NUMBER | SCHEM LOCATION | BOARD LOCATION | CIRCUIT NUMBER | SCHEM LOCATION | BOARD LOCATION | CIRCUIT NUMBER | SCHEM LOCATION | BOARD LOCATION | CIRCUIT NUMBER | SCHEM LOCATION | BOARD LOCATION |
|----------------|----------------|----------------|----------------|----------------|----------------|----------------|----------------|----------------|----------------|----------------|----------------|
| C2101 | A1 | A4 | J2132 | C1 | E4 | R2160 | D5 | E6 | R2258 | G2 | E5 |
| C2105 | A1 | A4 | J2138 | C1 | E4 | R2161 | C4 | A6 | R2259 | G2 | D4 |
| C2109 | B1 | B5 | J2139 | C1 | E4 | R2162 | C4 | C6 | R2260 | H2 | C4 |
| C2112 | A1 | B4 | J2192 | A1 | A3 | R2163 | C4 | C6 | R2263 | G2 | B4 |
| C2115 | A2 | 5A | J2296 | H4 | D4 | R2165 | C4 | A6 | R2264 | G2 | C4 |
| C2117 | A2 | A2 | J2299 | H1 | C4 | R2166 | C4 | C6 | R2265 | G2 | C4 |
| C2118 | A2 | A3 | | | | R2167 | C4 | C6 | R2266 | G3 | C4 |
| C2120 | B1 | B3 | L2212 | G1 | D3 | R2169 | B4 | A6 | R2267 | G3 | C4 |
| C2121 | A2 | A4 | L2277 | G3 | E4 | R2170 | B4 | B6 | R2268 | G3 | B4 |
| C2127 | B2 | C3 | | | | R2171 | B4 | B6 | R2269 | G3 | C4 |
| C2135 | B1 | E5 | P2112 | A1 | B4 | R2173 | B4 | A6 | R2271 | F3 | B3 |
| C2140 | C1 | D4 | P2118 | A2 | A6 | R2174 | B4 | C6 | R2276 | F3 | E3 |
| C2141* | D1 | D4 | P2118 | B3 | A6 | R2175 | C4 | B6 | R2277 | G3 | E3 |
| C2144 | B2 | E4 | P2175 | A1 | A2 | R2180 | D2 | A2 | R2279 | G3 | E3 |
| C2154 | E1 | C4 | P2184 | D3 | A5 | R2181 | C3 | D6 | R2280 | G4 | E3 |
| C2155 | E1 | C4 | P2265 | A3 | B6 | R2182 | C3 | C5 | R2286 | G4 | D1 |
| C2157 | A2 | C1 | P2266 | A3 | D6 | R2183 | D3 | D4 | R2288 | G5 | D2 |
| C2161 | D2 | A5 | P2267 | H4 | F6 | R2184 | D3 | D5 | R2289 | G5 | C2 |
| C2180 | A2 | C5 | | | | R2185 | E3 | E2 | R2290 | G5 | C2 |
| C2183 | D3 | C5 | Q2108 | B1 | A4 | R2186 | E2 | F4 | R2291 | G5 | C2 |
| C2185 | E3 | F3 | Q2112 | A1 | A5 | R2187 | E2 | C2 | R2292 | G4 | C2 |
| C2186 | A2 | F3 | Q2127 | C2 | C3 | R2191 | C5 | E6 | R2293 | G5 | C2 |
| C2187 | E2 | C2 | Q2131 | C1 | E4 | R2192 | C5 | E6 | R2296 | G4 | D5 |
| C2190 | A2 | C5 | Q2132 | C1 | E4 | R2193 | C5 | E6 | R2297 | G4 | D4 |
| C2201 | E1 | B1 | Q2138 | D1 | E5 | R2194 | C5 | E6 | R2298 | G4 | C5 |
| C2202 | A2 | C2 | Q2142 | D1 | C2 | R2196 | C5 | E6 | | | |
| C2203 | A2 | C1 | Q2151 | E1 | C4 | R2197 | C5 | D6 | U2120A | B1 | B4 |
| C2204 | A2 | B2 | Q2152 | E1 | C4 | R2198 | C5 | D6 | U2120B | B1 | B4 |
| C2211 | G1 | D3 | Q2153 | E1 | C4 | R2199 | C5 | D6 | U2120C | B1 | B4 |
| C2212 | H1 | D3 | Q2181 | D3 | E5 | R2201 | F1 | B1 | U2120D | B1 | B4 |
| C2213 | H1 | D2 | Q2223 | D4 | B5 | R2202 | E1 | E3 | U2126 | B1 | E4 |
| C2221 | C4 | D6 | Q2226 | D4 | B5 | R2203 | F1 | B1 | U2127A | C2 | D3 |
| C2239 | D5 | E6 | Q2227 | D4 | C5 | R2204 | G1 | B1 | U2127B | B2 | D3 |
| C2243 | A2 | E1 | Q2229 | D4 | B5 | R2206 | G1 | B2 | U2157A | F5 | C2 |
| C2244 | E4 | E1 | Q2243 | E5 | B5 | R2207 | G1 | B2 | U2157B | E1 | C2 |
| C2245 | A2 | D2 | Q2250 | F2 | E3 | R2208 | G1 | C2 | U2157C | F4 | C2 |
| C2246 | A2 | D2 | Q2255 | G2 | D3 | R2210 | G1 | D2 | U2157D | E2 | C2 |
| C2251 | A2 | D2 | Q2296 | G4 | D3 | R2211 | G1 | D3 | U2159 | D2 | E6 |
| C2259 | H2 | D4 | | | | R2212 | H1 | D3 | U2162 | D2 | B2 |
| C2263 | A2 | B5 | R2101 | A1 | A3 | R2213 | H1 | D2 | U2180 | C3 | D5 |
| C2276 | F3 | E4 | R2102 | A1 | B3 | R2216 | G1 | B1 | U2185 | E3 | E3 |
| C2277 | G3 | E4 | R2104 | A1 | A4 | R2217 | G1 | B1 | U2186 | F3 | E3 |
| C2279 | G3 | E3 | R2105 | A1 | A4 | R2218 | G1 | B1 | U2190 | C4 | C5 |
| C2297 | H4 | D4 | R2107 | A1 | A4 | R2221 | C4 | B5 | U2202A | F2 | C3 |
| CR2124 | B3 | E5 | R2108 | B1 | A4 | R2222 | D4 | B6 | U2202B | E1 | C3 |
| CR2125 | B2 | E5 | R2109 | B1 | B4 | R2223 | D4 | B6 | U2203 | F1 | C2 |
| CR2137 | D1 | E5 | R2112 | A1 | A4 | R2224 | D4 | B6 | U2204 | F1 | A2 |
| CR2139 | D1 | E5 | R2113 | A1 | B3 | R2225 | D4 | A5 | U2210A | G1 | D2 |
| CR2145 | C2 | D6 | R2122 | B2 | D5 | R2226 | D4 | A5 | U2210B | H1 | D2 |
| CR2146 | C2 | D6 | R2123 | B2 | D5 | R2227 | D4 | A5 | U2232 | D5 | E2 |
| CR2153 | E1 | C4 | R2125 | C2 | B3 | R2229 | D4 | B5 | U2244 | F4 | E2 |
| CR2157 | E1 | C3 | R2127 | C2 | C3 | R2230 | D4 | F4 | U2246 | F4 | D2 |
| CR2160 | D2 | B3 | R2131 | C1 | E5 | R2235 | D5 | F2 | U2251A | G2 | D1 |
| CR2161 | D2 | B5 | R2132 | C1 | D5 | R2236 | D5 | F2 | U2251B | F5 | D1 |
| CR2162 | C4 | C6 | R2134 | B1 | E5 | R2237 | D5 | F2 | U2251C | F5 | D1 |
| CR2163 | C4 | C6 | R2135 | B1 | F4 | R2238 | D5 | F2 | U2251D | F5 | D1 |
| CR2166 | C4 | C6 | R2137 | D1 | E5 | R2239 | D5 | E2 | U2257A | H4 | D4 |
| CR2167 | C4 | D7 | R2139 | D1 | E5 | R2242 | D4 | D6 | U2257B | H2 | D4 |
| CR2170 | B4 | B6 | R2140 | C1 | E4 | R2243 | D4 | E5 | U2263A | F2,G3 | B4 |
| CR2171 | B4 | B6 | R2141 | D1 | D4 | R2244 | E5 | B5 | U2264 | F3 | B3 |
| CR2174 | C4 | C6 | R2144 | B2 | F4 | R2245 | E4 | E1 | U2276A | F4 | D3 |
| CR2175 | C4 | C6 | R2146 | C2 | D6 | R2246 | D1,E4 | E1 | | | |
| CR2187 | E2 | B3 | R2150 | D1 | C4 | R2247 | F4 | E1 | VR2185 | E2 | F5 |
| CR2229 | D4 | F4 | R2151 | D1 | C4 | R2250 | F2 | E1 | VR2186 | E2 | F5 |
| CR2267 | F2 | E4 | R2152 | E1 | C4 | R2251 | F2 | E4 | VR2187 | E2 | F5 |
| CR2270 | F2 | B3 | R2153 | E1 | B3 | R2252 | G2 | D2 | | | |
| CR2271 | F2 | B3 | R2154 | E1 | C4 | R2253 | G2 | D2 | | | |
| | | | R2155 | E1 | C3 | R2254 | G2 | D2 | W2127 | C2 | C4 |
| | | | R2157 | E1 | B3 | R2255 | G2 | D2 | | | |
| E2132 | C1 | E4 | R2159 | D2 | A5 | R2257 | G2 | D4 | | | |

ASSEMBLY A27

| CIRCUIT NUMBER | SCHEM LOCATION | BOARD LOCATION | CIRCUIT NUMBER | SCHEM LOCATION | BOARD LOCATION | CIRCUIT NUMBER | SCHEM LOCATION | BOARD LOCATION |
|----------------|----------------|----------------|----------------|----------------|----------------|----------------|----------------|----------------|
| CR2236 | B3 | C2 | CR2250 | A4 | A1 | CR2264 | B5 | A2 |
| CR2237 | A3 | F1 | CR2251 | B4 | F2 | CR2265 | A5 | A2 |
| CR2238 | A3 | F1 | CR2252 | B4 | F2 | CR2266 | A5 | A2 |
| CR2239 | B3 | D2 | CR2253 | A4 | F2 | | | |
| CR2240 | B3 | D2 | CR2254 | A4 | F2 | P2265 | A3 | B3 |
| CR2241 | A3 | D2 | CR2255 | B4 | D1 | P2265 | A5 | B3 |
| CR2242 | A3 | D1 | CR2256 | B4 | D1 | P2266 | A3 | D3 |
| CR2243 | B3 | C1 | CR2257 | A4 | C1 | P2266 | A4 | D3 |
| CR2244 | B3 | C2 | CR2258 | A4 | C1 | | | |
| CR2245 | A3 | C2 | CR2259 | B4 | B2 | | | |
| CR2246 | A3 | C2 | CR2260 | B5 | B2 | | | |
| CR2247 | B3 | B1 | CR2261 | A5 | B2 | | | |
| CR2248 | B4 | B1 | CR2262 | A5 | B1 | | | |
| CR2249 | A4 | A1 | CR2263 | B5 | A2 | | | |

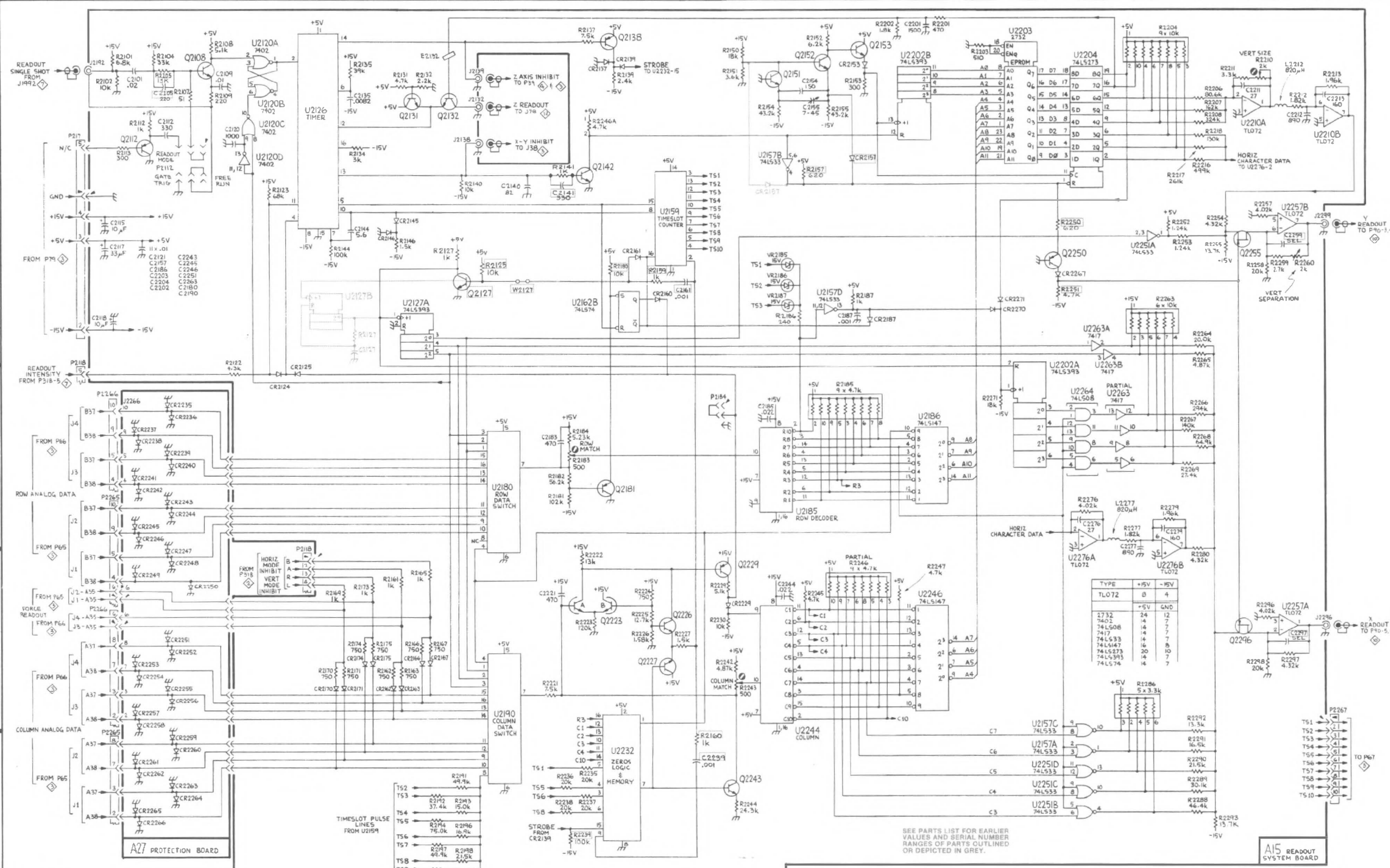

| TYPE | +5V | -5V |
|---------|-----|-----|
| TLO72 | 24 | 12 |
| 2732 | 24 | 12 |
| 7402 | 14 | 7 |
| 74LS08 | 14 | 7 |
| 7417 | 14 | 7 |
| 74LS533 | 14 | 7 |
| 74LS147 | 14 | 7 |
| 74LS273 | 20 | 10 |
| 74LS393 | 14 | 7 |
| 74LS147 | 14 | 7 |

SEE PARTS LIST FOR EARLIER VALUES AND SERIAL NUMBER RANGES OF PARTS OUTLINED OR DEPICTED IN GREY.

VOLTAGE AND WAVEFORM CONDITIONS

The voltages and waveforms shown were obtained with the 7904A front panel variable controls at midrange except A and B INTENSITY control is set fully counterclockwise; VERTICAL MODE, LEFT; TRIGGER SOURCE, VERT MODE; HORIZONTAL MODE, B; READOUT, PULSED; OUTPUTS, B + GATE.

Voltage Conditions. The voltages shown on the diagram were obtained using a digital multimeter with a 10 M Ω input impedance (TEKTRONIX DM 501A Digital Multimeter or TEKTRONIX 7D13A Digital Multimeter used with a readout-equipped 7000-series oscilloscope).

Waveform Conditions. The waveforms shown below were obtained using a test oscilloscope system with 10 M Ω input impedance and at least 60 MHz bandwidth. (TEKTRONIX 7603 Oscilloscope, 7B53A Time Base, and 7A13 Differential Comparator equipped with a 10X probe.) A 7B-series time-base plug-in (the only plug-in installed in the 7904A) was installed in the 7904A B HORIZ compartment and set to 1 μ s/div.

Voltages shown near the waveforms are display center dc levels.

1

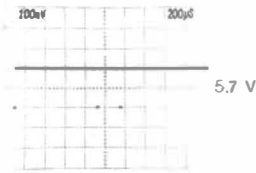

2

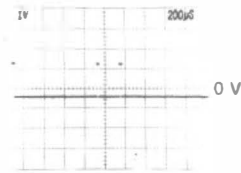

3

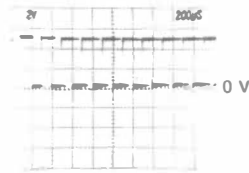

4

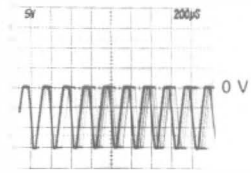

5

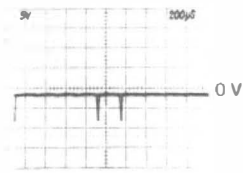

6

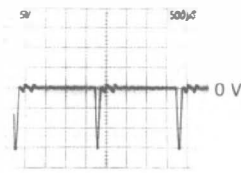

7

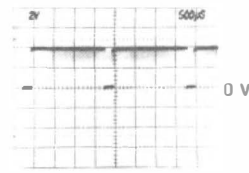

8

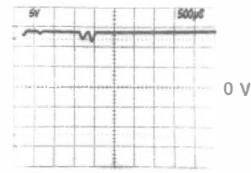

9

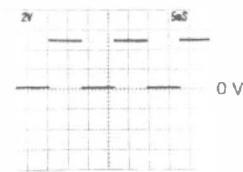

10

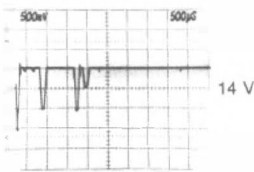

11

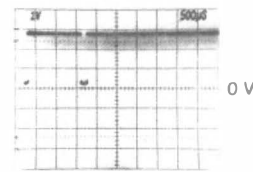

12

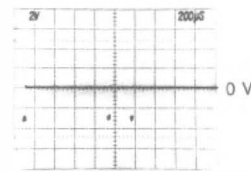

13

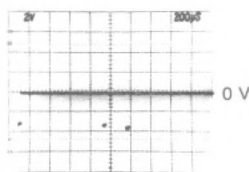

A

B

C

D

E

F

G

1

2

3

4

5

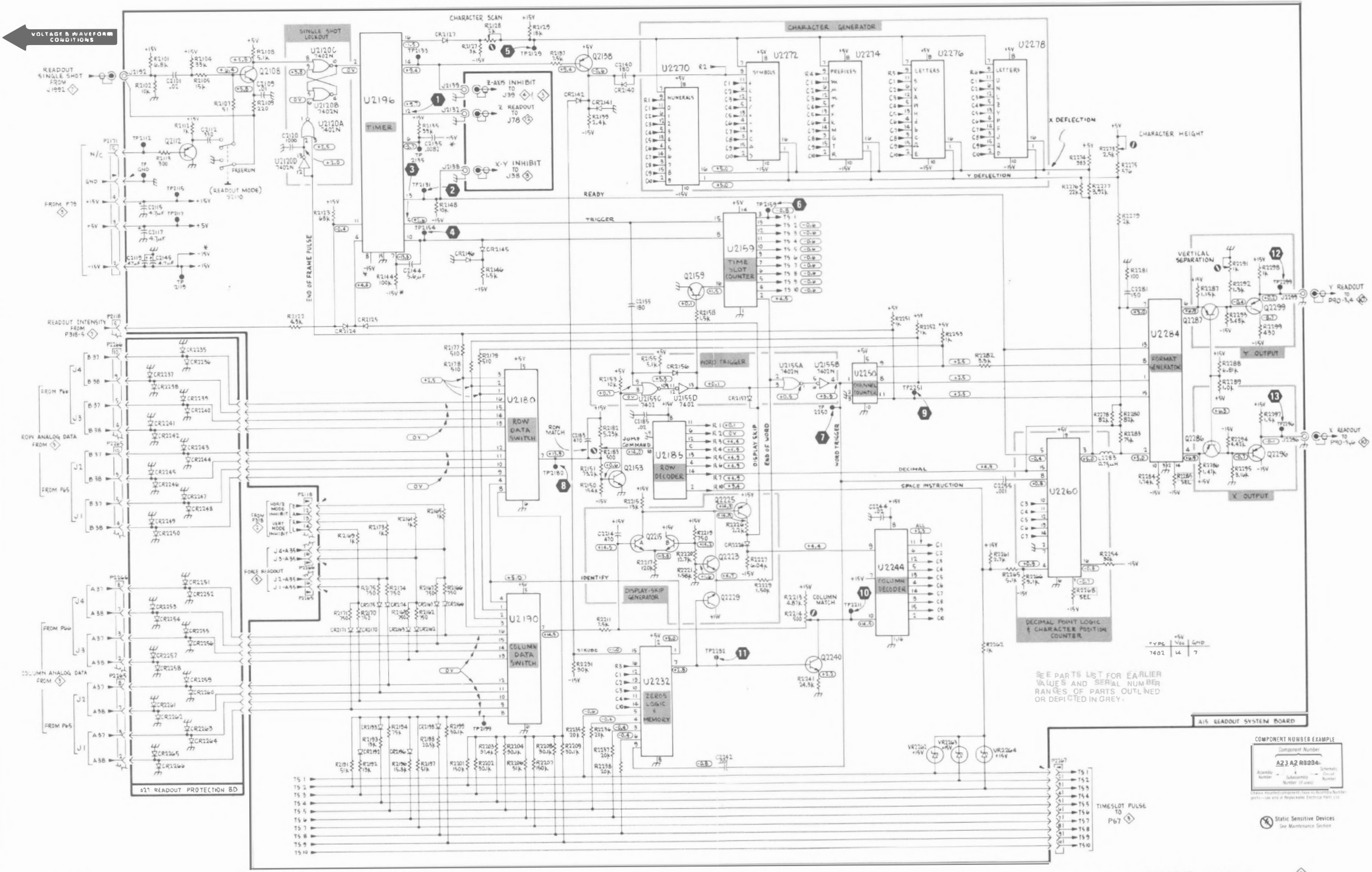

SIGNALS OUT & INTENSITY LIMITER DIAGRAM

7

ASSEMBLY A1

| CIRCUIT NUMBER | SCHEM LOCATION | BOARD LOCATION | CIRCUIT NUMBER | SCHEM LOCATION | BOARD LOCATION | CIRCUIT NUMBER | SCHEM LOCATION | BOARD LOCATION |
|----------------|----------------|----------------|----------------|----------------|----------------|----------------|----------------|----------------|
| C1901 | B4 | B2 | P1910 | D2 | B4 | R1937 | E3 | D3 |
| C1904 | A4 | B2 | P1917 | A1 | A4 | R1938 | E3 | D2 |
| C1906 | B3 | B2 | | | | R1940 | F3 | F3 |
| C1908 | B3 | A3 | Q1908 | A3 | B3 | R1941 | F4 | E3 |
| C1914 | C4 | C2 | Q1910 | A2 | B3 | R1942 | F3 | E3 |
| C1918 | B5 | B2 | Q1916 | C4 | C3 | R1943 | E3 | E3 |
| C1919 | B5 | B2 | Q1928 | E2 | D3 | R1944 | F3 | F3 |
| C1920 | C4 | D2 | Q1934 | E4 | D3 | R1945 | F3 | E2 |
| C1921 | C4 | D2 | Q1938 | E4 | D3 | R1946 | E3 | F3 |
| C1935 | E4 | D3 | Q1942 | F3 | F3 | R1948 | F2 | F4 |
| C1938 | E3 | D4 | Q1943 | F3 | F3 | R1950 | G5 | F4 |
| C1950 | G5 | F4 | Q1946 | F2 | E2 | R1951 | G5 | E4 |
| C1952 | G5 | E4 | Q1956 | G3 | B4 | R1952 | G4 | C4 |
| C1953 | F5 | F4 | | | | R1953 | F5 | E4 |
| C1955 | G4 | D4 | R1900 | A4 | C1 | R1954 | G4 | C4 |
| C1956 | G3 | D4 | R1901 | A4 | A2 | R1955 | G4 | D4 |
| C1994 | B2 | B4 | R1902 | A3 | B2 | R1956 | G3 | C4 |
| C1995 | B2 | D4 | R1903 | A4 | A2 | R1957 | G3 | B4 |
| C1997 | C2 | D4 | R1905 | A3 | B2 | R1960 | G3 | C4 |
| | | | R1906 | B3 | B2 | R1960 | G4 | C4 |
| CR1900 | A2 | C2 | R1908 | A3 | B3 | R1963 | G3 | B4 |
| CR1902 | A2 | C2 | R1909 | A3 | B3 | R1964 | G3 | B4 |
| CR1916 | C4 | B2 | R1910 | A2 | B3 | R1965 | G3 | B4 |
| CR1918 | B5 | B3 | R1911 | E4 | C2 | R1966 | G3 | B4 |
| CR1922 | C3 | D2 | R1914 | D4 | C3 | | | |
| CR1923 | C3 | D2 | R1915 | C4 | C2 | S1900A | A2 | C2 |
| CR1927 | E2 | D3 | R1916 | C4 | B2 | S1900B | A2 | C2 |
| CR1928 | E2 | C2 | R1917 | B5 | B3 | S1905 | B4 | A2 |
| CR1929 | E2 | C2 | R1918 | B5 | B3 | S1910 | B4 | B2 |
| CR1946 | E3 | E3 | R1919 | B5 | B2 | S1915 | C4 | D2 |
| CR1947 | F2 | E4 | R1920 | C4 | C2 | S1920 | C4 | D2 |
| CR1948 | F2 | F4 | R1921 | C4 | D2 | S1924A | D3 | E2 |
| CR1963 | G3 | C4 | R1922 | D3 | F2 | S1924B | D3 | E2 |
| E1946 | F2 | E2 | R1923 | D4 | D2 | S1924C | D3 | E2 |
| J1917 | B5 | C3 | P1924 | D4 | E2 | S1924D | C2 | E2 |
| J1924 | E1 | C3 | R1925 | D3 | E2 | S1930 | E5 | C3 |
| J1943 | F1 | E4 | R1926 | E2 | D3 | S1940 | F4 | E3 |
| J1992 | C1 | D3 | R1927 | E3 | D3 | | | |
| | | | R1928 | E2 | D3 | TP1908 | A3 | B3 |
| L1995 | B1 | D4 | R1929 | E2 | C2 | TP1925 | D3 | E3 |
| L1997 | C1 | D4 | R1930 | E5 | C3 | TP1952 | G4 | E4 |
| | | | R1931 | E5 | C4 | TP1958 | G3 | C4 |
| P1900 | E5 | E4 | R1932 | E4 | C3 | | | |
| P1904 | B1 | E5 | R1933 | E5 | D3 | U1952 | G5 | E4 |
| P1904 | D1 | E5 | R1934 | E4 | D3 | U1958 | G3 | C4 |
| P1904 | G1 | E5 | R1935 | E4 | D3 | | | |
| P1904 | G5 | E5 | R1936 | E3 | D3 | VR1910 | A2 | B3 |

Partial A1 also shown on diagram 2

ASSEMBLY A5

| CIRCUIT NUMBER | SCHEM LOCATION | BOARD LOCATION | CIRCUIT NUMBER | SCHEM LOCATION | BOARD LOCATION |
|----------------|----------------|----------------|----------------|----------------|----------------|
| P310 | D2 | I2 | P318 | D1 | H2 |

Partial A5 also shown on diagrams 2 and 4

CHASSIS MOUNTED PARTS

| CIRCUIT NUMBER | SCHEM LOCATION | BOARD LOCATION | CIRCUIT NUMBER | SCHEM LOCATION | BOARD LOCATION | CIRCUIT NUMBER | SCHEM LOCATION | BOARD LOCATION |
|----------------|----------------|----------------|----------------|----------------|----------------|----------------|----------------|----------------|
| J1916 | B6 | CHASSIS | J1925 | E1 | CHASSIS | J1944 | F1 | CHASSIS |

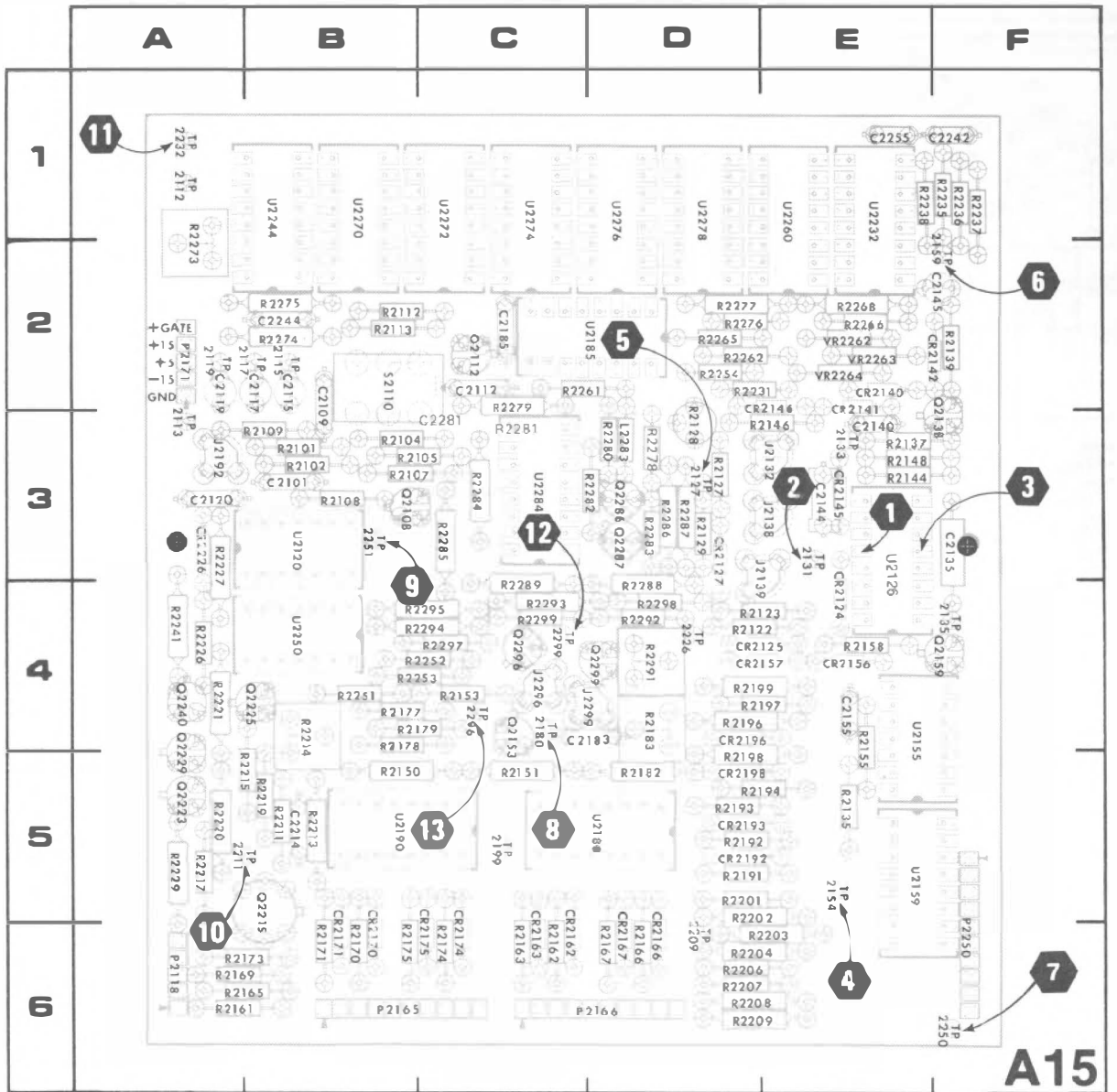

4593-807A

Figure 8-9. A15—Readout System circuit board assembly (SN B031766-Below)

VOLTAGE AND WAVEFORM CONDITIONS

The voltages and waveforms shown were obtained with the 7904A front panel variable controls at midrange except A and B INTENSITY control is set fully counterclockwise; VERTICAL MODE, LEFT; TRIGGER SOURCE, VERT MODE; HORIZONTAL MODE, B; READOUT, PULSED; OUTPUTS, B + GATE.

Voltage Conditions. The voltages shown on the diagram were obtained using a digital multimeter with a 10 M Ω input impedance (TEKTRONIX DM 501A Digital Multimeter or TEKTRONIX 7D13A Digital Multimeter used with a readout-equipped 7000-series oscilloscope).

Waveform Conditions. The waveforms shown below were obtained using a test oscilloscope system with 10 M Ω input impedance and at least 60 MHz bandwidth. (TEKTRONIX 7603 Oscilloscope, 7B53A Time Base, and 7A13 Differential Comparator equipped with a 10X probe.) A 7B-series time-base plug-in (the only plug-in installed in the 7904A) was installed in the 7904A B HORIZ compartment and set to 1 μ s/div.

Voltages shown near the waveforms are display center dc levels.

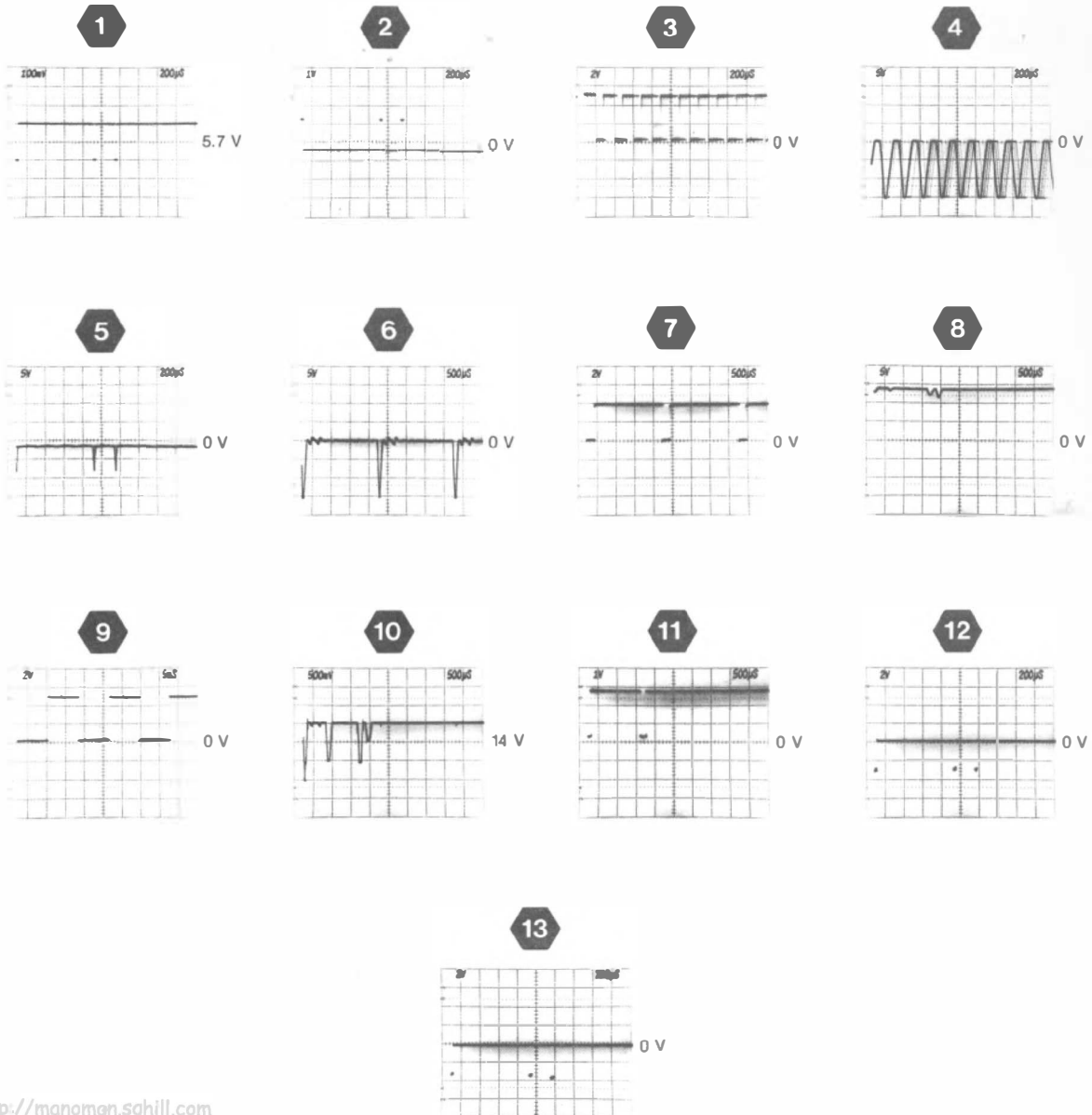

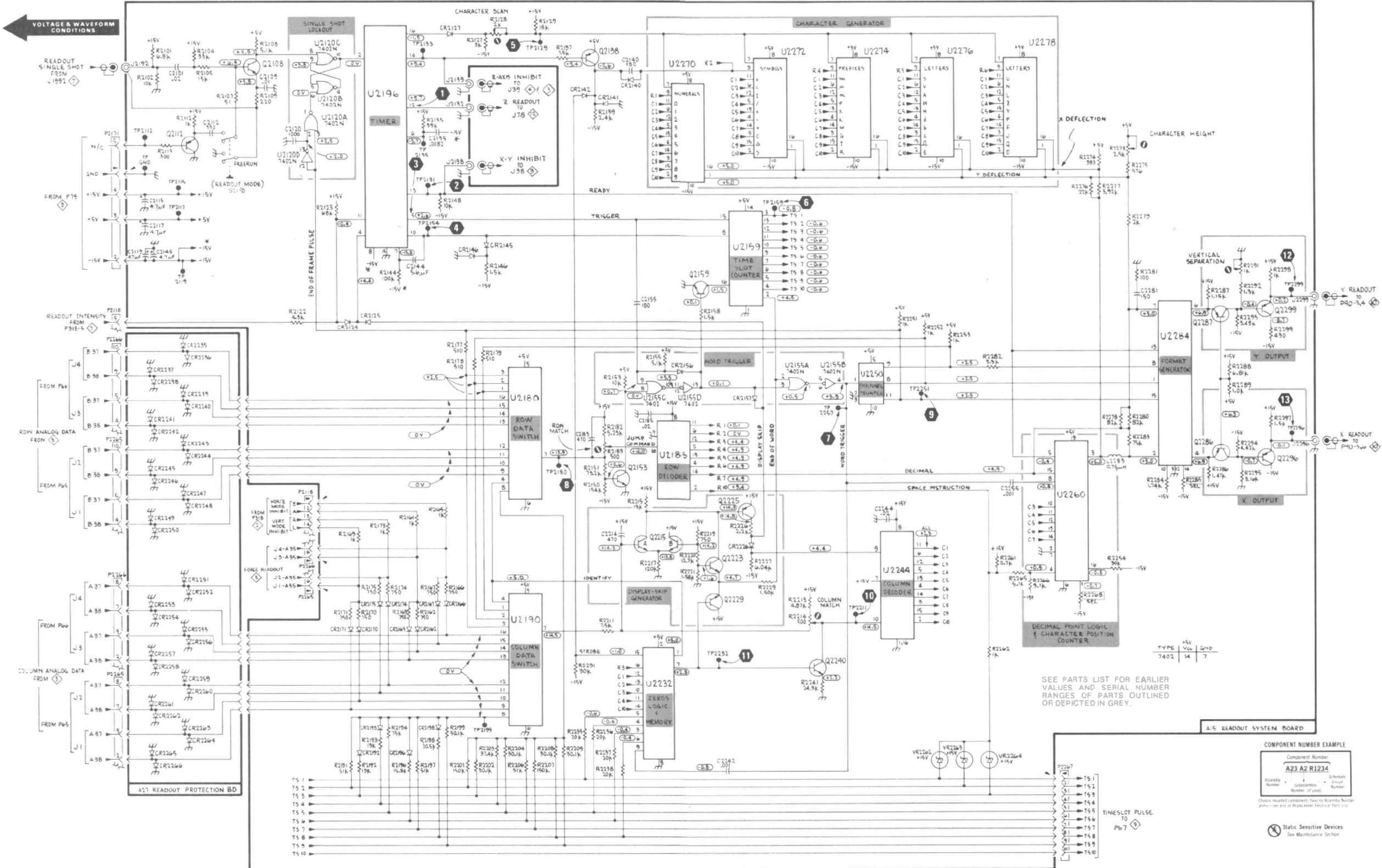

SEE PARTS LIST FOR EARLIER VALUES AND SERIAL NUMBER RANGES OF PARTS OUTLINED OR DEPICTED IN GREY.

COMPONENT NUMBER EXAMPLE

| | | |
|------------------|------------------------------|------------------------|
| Component Number | | |
| A23 A2 | R1234 | |
| Assembly Number | Subassembly Number (if used) | Schematic Group Number |

Check mounted components face to Assembly Number pins—see end of Manufacturer's Electrical Parts List.

E1946

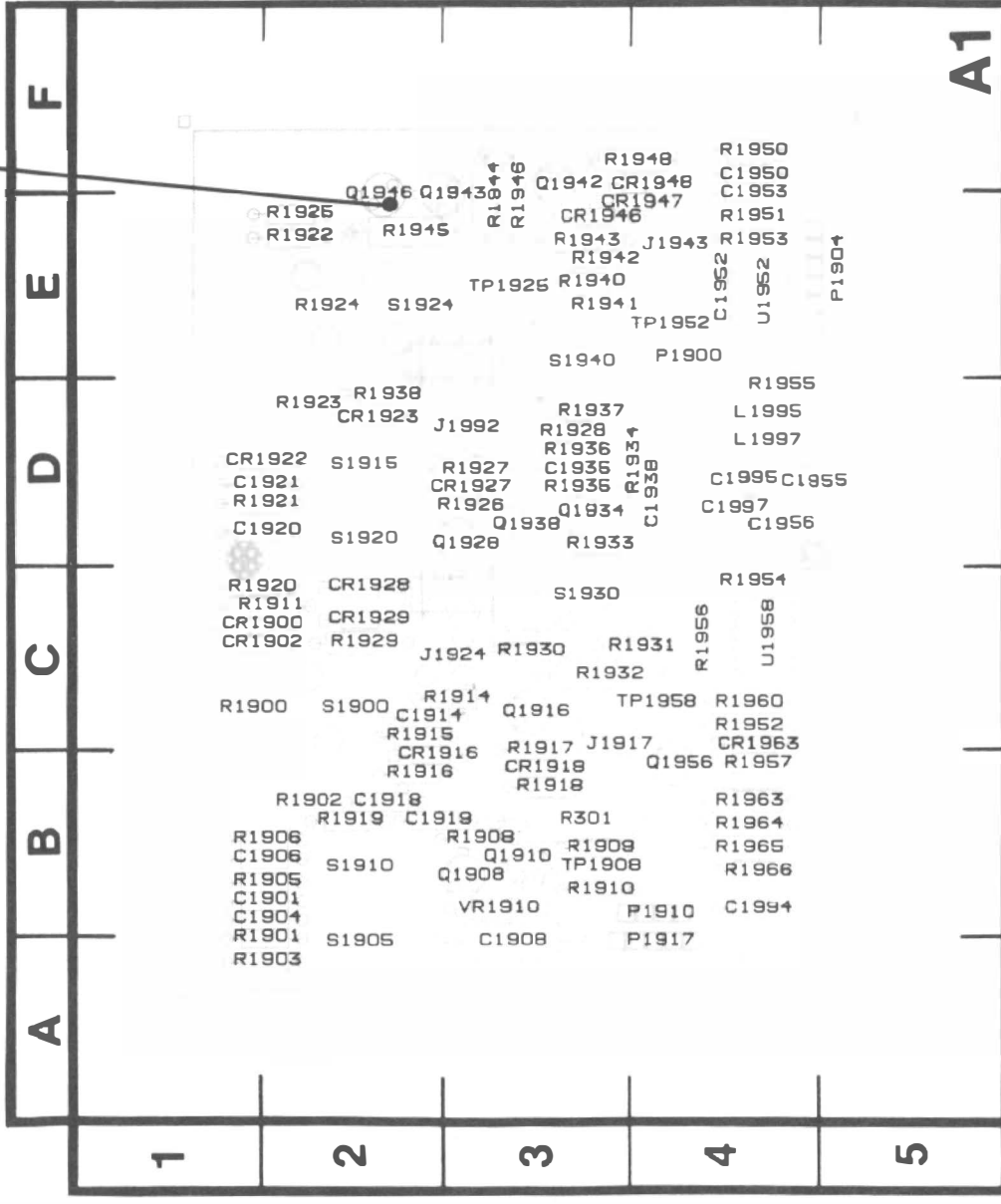

4593-809

Figure 8-10. A1—Front Panel circuit board assembly.

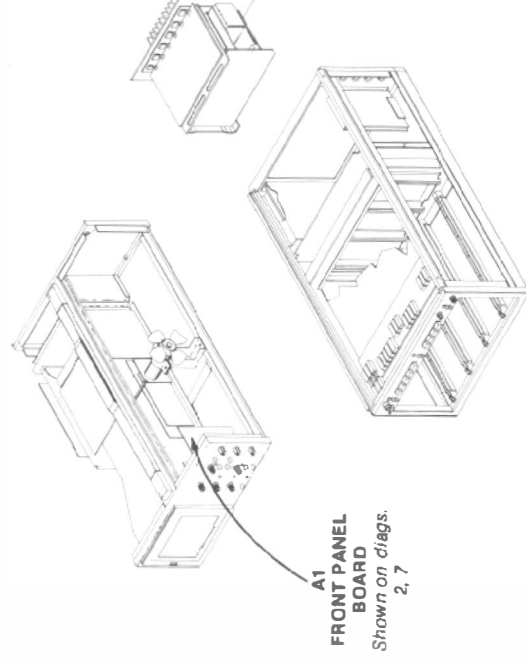

COMPONENT NUMBER EXAMPLE

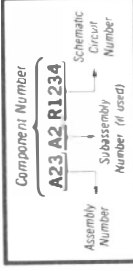

Chassis mounted components have no Assembly Number
Prefix—see end of Replaceable Electrical Parts List
<http://7777.mdnormn.sgmll.com>

SIGNALS OUT & INTENSITY LIMITER DIAGRAM

7

ASSEMBLY A1

| CIRCUIT NUMBER | SCHEM LOCATION | BOARD LOCATION | CIRCUIT NUMBER | SCHEM LOCATION | BOARD LOCATION | CIRCUIT NUMBER | SCHEM LOCATION | BOARD LOCATION |
|----------------|----------------|----------------|----------------|----------------|----------------|----------------|----------------|----------------|
| C1901 | B4 | B2 | P1910 | D2 | B4 | R1937 | E3 | D3 |
| C1904 | A4 | B2 | P1917 | A1 | A4 | R1938 | E3 | D2 |
| C1906 | B3 | B2 | | | | R1940 | F3 | E3 |
| C1908 | B3 | A3 | Q1908 | A3 | B3 | R1941 | F4 | E3 |
| C1914 | C4 | C2 | Q1910 | A2 | B3 | R1942 | F3 | E3 |
| C1918 | B5 | B2 | Q1916 | C4 | C3 | R1943 | E3 | E3 |
| C1919 | B5 | B2 | Q1928 | E2 | D3 | R1944 | F3 | F3 |
| C1920 | C4 | D2 | Q1934 | E4 | D3 | R1945 | F3 | E2 |
| C1921 | C4 | D2 | Q1938 | E4 | D3 | R1946 | E3 | F3 |
| C1935 | E4 | D3 | Q1942 | F3 | F3 | R1948 | F2 | F4 |
| C1938 | E3 | D4 | Q1943 | F3 | F3 | R1950 | G5 | F4 |
| C1950 | G5 | F4 | Q1946 | F2 | E2 | R1951 | G5 | E4 |
| C1952 | G5 | E4 | Q1956 | G3 | B4 | R1952 | G4 | C4 |
| C1953 | F5 | F4 | | | | R1953 | F5 | E4 |
| C1955 | G4 | D4 | R1900 | A4 | C1 | R1954 | G4 | C4 |
| C1956 | G3 | D4 | R1901 | A4 | A2 | R1955 | G4 | D4 |
| C1994 | B2 | B4 | R1902 | A3 | B2 | R1956 | G3 | C4 |
| C1995 | B2 | D4 | R1903 | A4 | A2 | R1957 | G3 | B4 |
| C1997 | C2 | D4 | R1905 | A3 | B2 | R1960 | G3 | C4 |
| | | | R1906 | B3 | B2 | R1960 | G4 | C4 |
| CR1900 | A2 | C2 | R1908 | A3 | B3 | R1963 | G3 | B4 |
| CR1902 | A2 | C2 | R1909 | A3 | B3 | R1964 | G3 | B4 |
| CR1916 | C4 | B2 | R1910 | A2 | B3 | R1965 | G3 | B4 |
| CR1918 | B5 | B3 | R1911 | E4 | C2 | R1966 | G3 | B4 |
| CR1922 | C3 | D2 | R1914 | D4 | C3 | | | |
| CR1923 | C3 | D2 | R1915 | C4 | C2 | S1900A | A2 | C2 |
| CR1927 | E2 | D3 | R1916 | C4 | B2 | S1900B | A2 | C2 |
| CR1928 | E2 | C2 | R1917 | B5 | B3 | S1905 | B4 | A2 |
| CR1929 | E2 | C2 | R1918 | B5 | B3 | S1910 | B4 | B2 |
| CR1946 | E3 | E3 | R1919 | B5 | B2 | S1915 | C4 | D2 |
| CR1947 | F2 | E4 | R1920 | C4 | C2 | S1920 | C4 | D2 |
| CR1948 | F2 | F4 | R1921 | C4 | D2 | S1924A | D3 | E2 |
| CR1963 | G3 | C4 | R1922 | D3 | E2 | S1924B | D3 | E2 |
| F1946 | F2 | E2 | R1923 | D4 | D2 | S1924C | D3 | E2 |
| J1917 | B5 | C3 | R1924 | D4 | E2 | S1924D | C2 | E2 |
| J1924 | E1 | C3 | R1925 | D3 | E2 | S1930 | E5 | C3 |
| J1943 | F1 | E4 | R1926 | E2 | D3 | S1940 | F4 | E3 |
| J1992 | C1 | D3 | R1927 | E3 | D3 | | | |
| | | | R1928 | E2 | D3 | TP1908 | A3 | B3 |
| L1995 | B1 | D4 | R1929 | E2 | C2 | TP1925 | D3 | E3 |
| L1997 | C1 | D4 | R1930 | E5 | C3 | TP1952 | G4 | E4 |
| | | | R1931 | E5 | C4 | TP1958 | G3 | C4 |
| P1900 | E5 | E4 | R1932 | E4 | C3 | | | |
| P1904 | B1 | E5 | R1933 | E5 | D3 | U1952 | G5 | E4 |
| P1904 | D1 | E5 | R1934 | E4 | D3 | U1958 | G3 | C4 |
| P1904 | G1 | E5 | R1935 | E4 | D3 | | | |
| P1904 | G5 | E5 | R1936 | E3 | D3 | VR1910 | A2 | B3 |

Partial A1 also shown on diagram 2

ASSEMBLY A5

| CIRCUIT NUMBER | SCHEM LOCATION | BOARD LOCATION | CIRCUIT NUMBER | SCHEM LOCATION | BOARD LOCATION |
|----------------|----------------|----------------|----------------|----------------|----------------|
| P310 | D2 | I2 | P318 | D1 | H2 |

Partial A5 also shown on diagrams 2 and 4

CHASSIS MOUNTED PARTS

| CIRCUIT NUMBER | SCHEM LOCATION | BOARD LOCATION | CIRCUIT NUMBER | SCHEM LOCATION | BOARD LOCATION | CIRCUIT NUMBER | SCHEM LOCATION | BOARD LOCATION |
|----------------|----------------|----------------|----------------|----------------|----------------|----------------|----------------|----------------|
| J1916 | B6 | CHASSIS | J1925 | E1 | CHASSIS | J1944 | F1 | CHASSIS |

VOLTAGE CONDITIONS

The voltages shown were obtained with the 7904A front panel variable controls at midrange except INTENSITY control is set fully counterclockwise; VERTICAL MODE, LEFT; TRIGGER SOURCE, VERT MODE; HORIZONTAL MODE, B. No plug-in units were installed.

Voltage Conditions. The voltages shown on the diagram were obtained using a digital multimeter with a 10M Ω input impedance (TEKTRONIX DM 501A Digital Multimeter or TEKTRONIX 7D13A Digital Multimeter used with a readout-equipped 7000-series Oscilloscope).

<http://manoman.sqhill.com>

VOLTAGE & WAVEFORM CONDITIONS

7904A

4593-83%
REV MAY 1969

SIGNALS OUT & INTENSITY LIMITER

7

Static Sensitive Devices
See Maintenance Section

COMPONENT NUMBER EXAMPLE
Component Number
A23 A2 R1234
Assembly
Station
Order
Number (if any)

| TYPE | +15V | -15V | GND |
|-------|------|------|-----|
| U1952 | 7 | 4 | 4 |
| U1958 | 8 | 4 | |

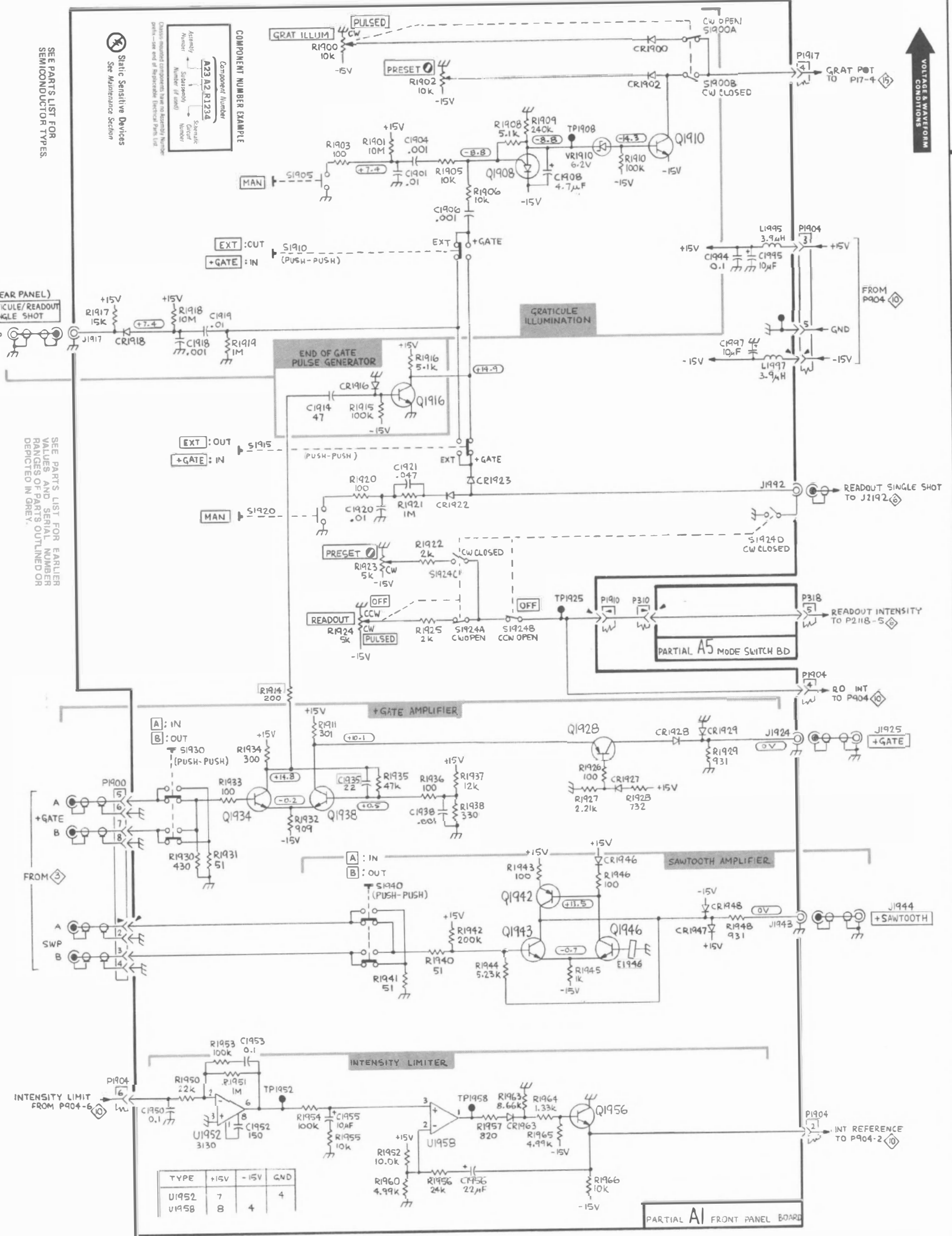

PARTIAL A1 FRONT PANEL BOARD

A
B
C
D
E
F
G

SEE PARTS LIST FOR SEMICONDUCTOR TYPES

SEE PARTS LIST FOR EARLIER VALUES AND SERIAL NUMBER RANGES OF PARTS OUTLINED OR DEPICTED IN GREY.

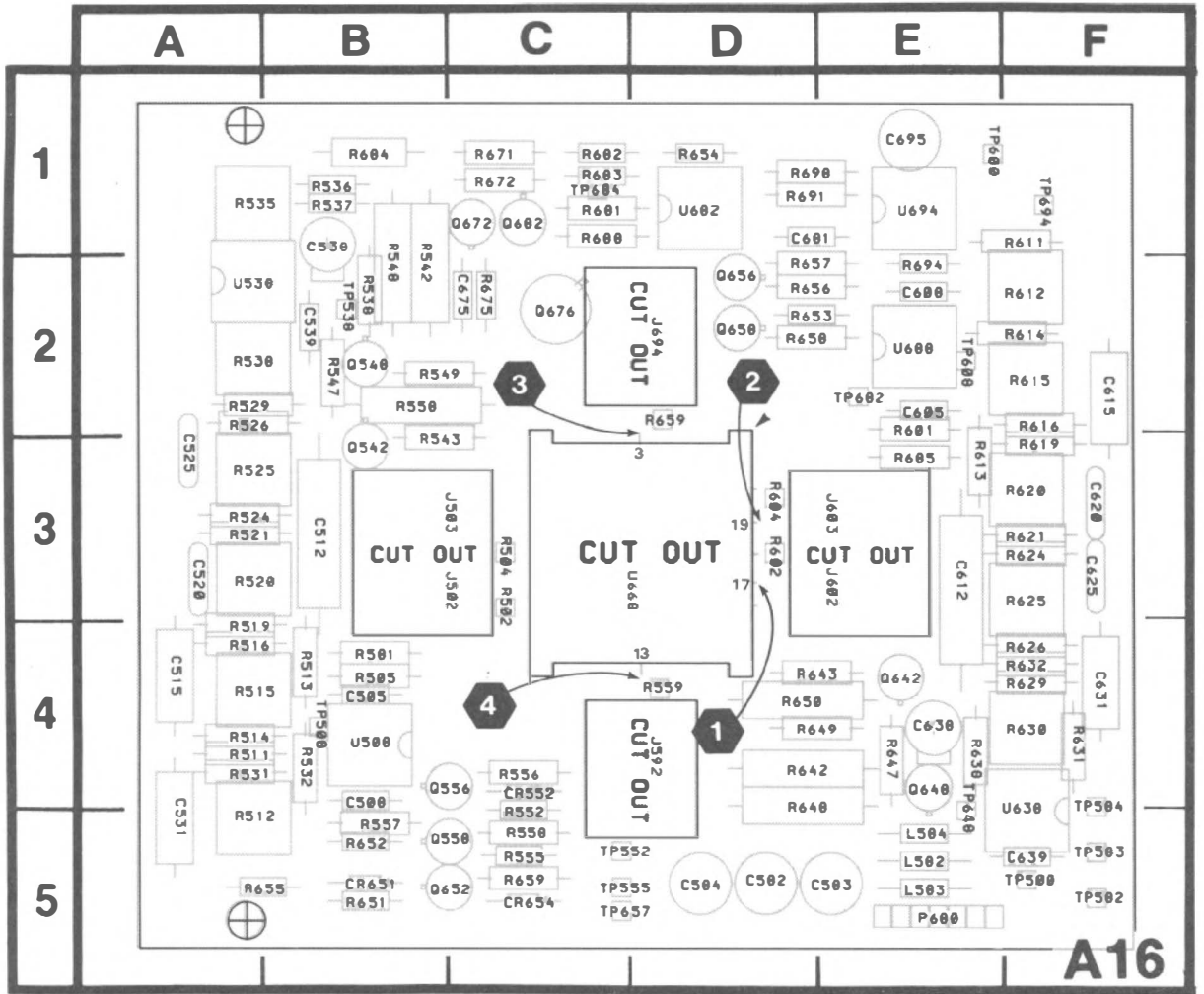
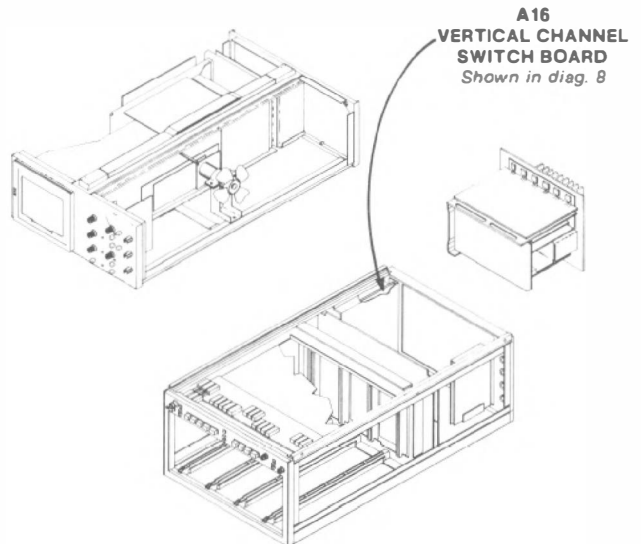

Figure 8-11. A16—Vertical Channel Switch circuit board assembly.

4593-810

REV SEP 1983



VERTICAL CHANNEL SWITCH DIAGRAM 8

ASSEMBLY A16

| CIRCUIT NUMBER | SCHEM LOCATION | BOARD LOCATION | CIRCUIT NUMBER | SCHEM LOCATION | BOARD LOCATION | CIRCUIT NUMBER | SCHEM LOCATION | BOARD LOCATION |
|----------------|----------------|----------------|----------------|----------------|----------------|----------------|----------------|----------------|
| C505 | B5 | B4 | R501 | B5 | B4 | R632 | F3 | F4 |
| C508 | A2 | B4 | R502 | B5 | C3 | R638 | G3 | E4 |
| C512 | B5 | B3 | R504 | B5 | C3 | R642 | F3 | D4 |
| C515 | B4 | A4 | R505 | B5 | B4 | R643 | F3 | D4 |
| C520 | B4 | A3 | R511 | A4 | A4 | R646 | D3 | G5 |
| C525 | B4 | A3 | R512 | B4 | A5 | R647 | F3 | E4 |
| C531 | B3 | A5 | R513 | B5 | B4 | R648 | F2 | D4 |
| C538 | A3 | B1 | R514 | A4 | A4 | R649 | F2 | D4 |
| C539 | A1 | B2 | R515 | B4 | A4 | R650 | E3 | D4 |
| C582 | G5 | D5 | R516 | B4 | A4 | R651 | D5 | B5 |
| C583 | G5 | E5 | R519 | A4 | A4 | R652 | D4 | B5 |
| C584 | G5 | D5 | R520 | B4 | A3 | R653 | D4 | D2 |
| C605 | E5 | E2 | R521 | B4 | A3 | R654 | D4 | D1 |
| C608 | F2 | E2 | R524 | A3 | A3 | R655 | D4 | A5 |
| C612 | F5 | E3 | R525 | B4 | A3 | R656 | D3 | D2 |
| C615 | F4 | F2 | R526 | B4 | A2 | R657 | D4 | D2 |
| C620 | F4 | F3 | R529 | A3 | A2 | R658 | D3 | D2 |
| C625 | F4 | F3 | R530 | B3 | A2 | R659 | E2 | C5 |
| C631 | F3 | F4 | R531 | B3 | A4 | R671 | D1 | C1 |
| C638 | G3 | E4 | R532 | B3 | B4 | R672 | D1 | C1 |
| C639 | F1 | F5 | R535 | A5 | A1 | R675 | D1 | C2 |
| C675 | D1 | C2 | R536 | A5 | B1 | R680 | C2 | C1 |
| C681 | D1 | D1 | R537 | A5 | B1 | R681 | D2 | C1 |
| C695 | G1 | E1 | R538 | A3 | B2 | R682 | C1 | C1 |
| | | | R542 | A3 | B2 | R683 | D1 | C1 |
| CR552 | C5 | C4 | R543 | B3 | B3 | R684 | C1 | B1 |
| CR651 | D5 | B5 | R547 | A3 | B2 | R690 | G2 | D1 |
| CR654 | D4 | C5 | R548 | A2 | B2 | R691 | G2 | D1 |
| | | | R549 | B2 | B2 | R694 | G2 | E2 |
| J502 | C5 | C3 | R550 | B3 | B2 | TP500 | G5 | B4 |
| J503 | B5 | C3 | R552 | C5 | C4 | TP508 | B4 | B4 |
| J592 | C2 | D4 | R555 | D4 | C5 | TP538 | A2 | B2 |
| J602 | E5 | E3 | R556 | C3 | C4 | TP552 | C5 | C5 |
| J603 | E5 | E3 | R557 | C4 | B5 | TP555 | D5 | C5 |
| J694 | E2 | D2 | R558 | C3 | C5 | TP582 | G5 | F5 |
| | | | R559 | C2 | D4 | TP583 | G5 | F5 |
| L582 | G5 | E5 | R601 | F5 | E2 | TP584 | G5 | F4 |
| L583 | G5 | E5 | R602 | F5 | D3 | TP600 | G5 | E1 |
| L584 | G5 | E5 | R604 | E5 | D3 | TP608 | F4 | E2 |
| | | | R605 | E5 | E3 | TP648 | F2 | E5 |
| P680 | C5 | E5 | R611 | F4 | F1 | TP657 | D5 | C5 |
| | | | R612 | F4 | F2 | TP682 | D2 | E2 |
| Q542 | A3 | B3 | R613 | F5 | E3 | TP684 | C1 | C1 |
| Q548 | A2 | B2 | R614 | F4 | F2 | TP694 | G1 | F1 |
| Q556 | C4 | B4 | R615 | F4 | F2 | U508 | A2 | B4 |
| Q558 | C4 | C5 | R616 | F4 | F2 | U508 | B5 | B4 |
| Q642 | F3 | E4 | R619 | F4 | F3 | U538 | A1 | A2 |
| Q648 | F2 | E4 | R620 | F4 | F3 | U538 | A3 | A2 |
| Q652 | D4 | C5 | R621 | F4 | F3 | U608 | F2 | E2 |
| Q656 | D4 | D2 | R624 | F3 | F3 | U608 | F5 | E2 |
| Q658 | D4 | D2 | R625 | F4 | F3 | U638 | F1 | F4 |
| Q672 | D1 | C1 | R626 | F4 | F4 | U638 | F3 | F4 |
| Q676 | D1 | C2 | R629 | F3 | F4 | U668 | B2 | D3 |
| Q682 | C1 | C1 | R630 | F3 | F4 | U682 | D1 | D1 |
| | | | R631 | F3 | F4 | U694 | G2 | E1 |

VOLTAGE AND WAVEFORM CONDITIONS

The voltages and waveforms shown were obtained with the 7904A front panel variable controls at midrange except A INTENSITY control is set counterclockwise; voltmeter ground is connected to chassis ground; VERTICAL MODE, LEFT; TRIGGER SOURCE, VERT MODE; HORIZONTAL MODE, B; and READOUT OFF.

Voltage Conditions. The voltages shown on the diagram were obtained using a digital multimeter with a 10 M Ω input impedance (TEKTRONIX DM 501A Digital Multimeter or TEKTRONIX 7D13A Digital Multimeter used with a readout-equipped 7000-series oscilloscope).

Waveform Conditions. The waveforms shown below were obtained using a test oscilloscope system with 10 M Ω input impedance and at least 60 MHz bandwidth. (TEKTRONIX 7603 Oscilloscope, 7B53A Time Base, and 7A13 Differential Comparator equipped with a 10X probe.) The test oscilloscope was externally triggered from the Pretrig Out connector of a 067-0587-02 Calibration Fixture installed in the 7904A LEFT VERT compartment. Calibration Fixture was set: +Step Resp (Vert), 10 kHz Rep Rate, and 2 divisions of vertical display centered at 0 volts. The test oscilloscope time base installed in the B HORIZ compartment was set: free-running sweep (not triggered), 50 ns/Div, +Slope, Auto, Ac, and Ext.

Voltages shown near the waveforms are display center dc levels.

1

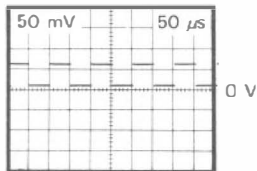

2

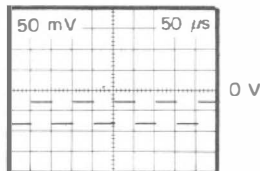

3

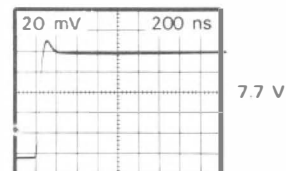

4

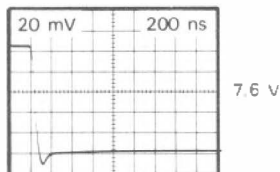

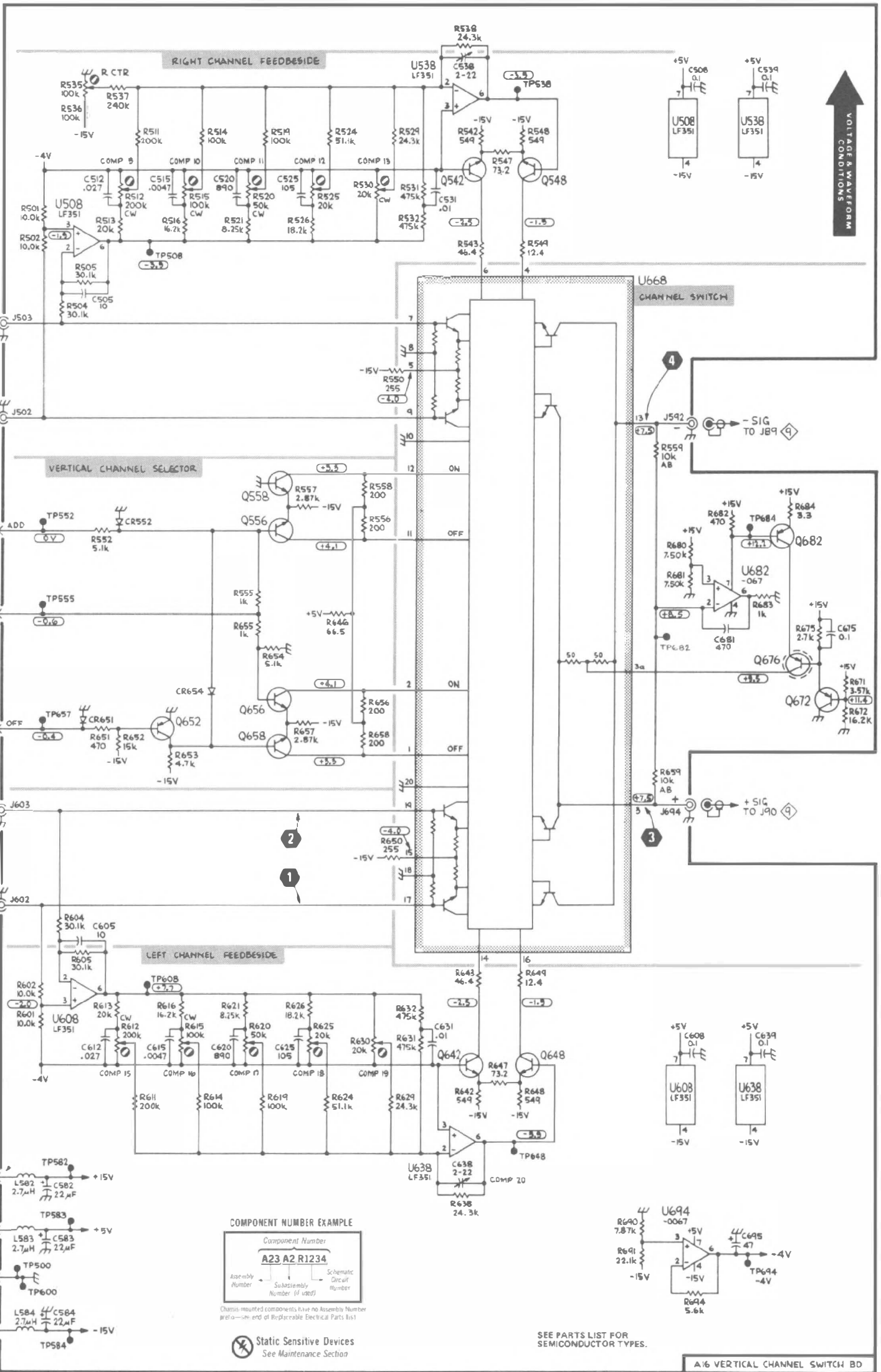

COMPONENT NUMBER EXAMPLE

| | | | |
|------------------|------------------------------|--------------------------|--|
| Component Number | | | |
| A23 | A2 | R1234 | |
| Assembly Number | Subassembly Number (if used) | Schematic Circuit Number | |

Chassis mounted components have no Assembly Number prefix—see end of Replaceable Electrical Parts list

⊗ Static Sensitive Devices
See Maintenance Section

SEE PARTS LIST FOR SEMICONDUCTOR TYPES.

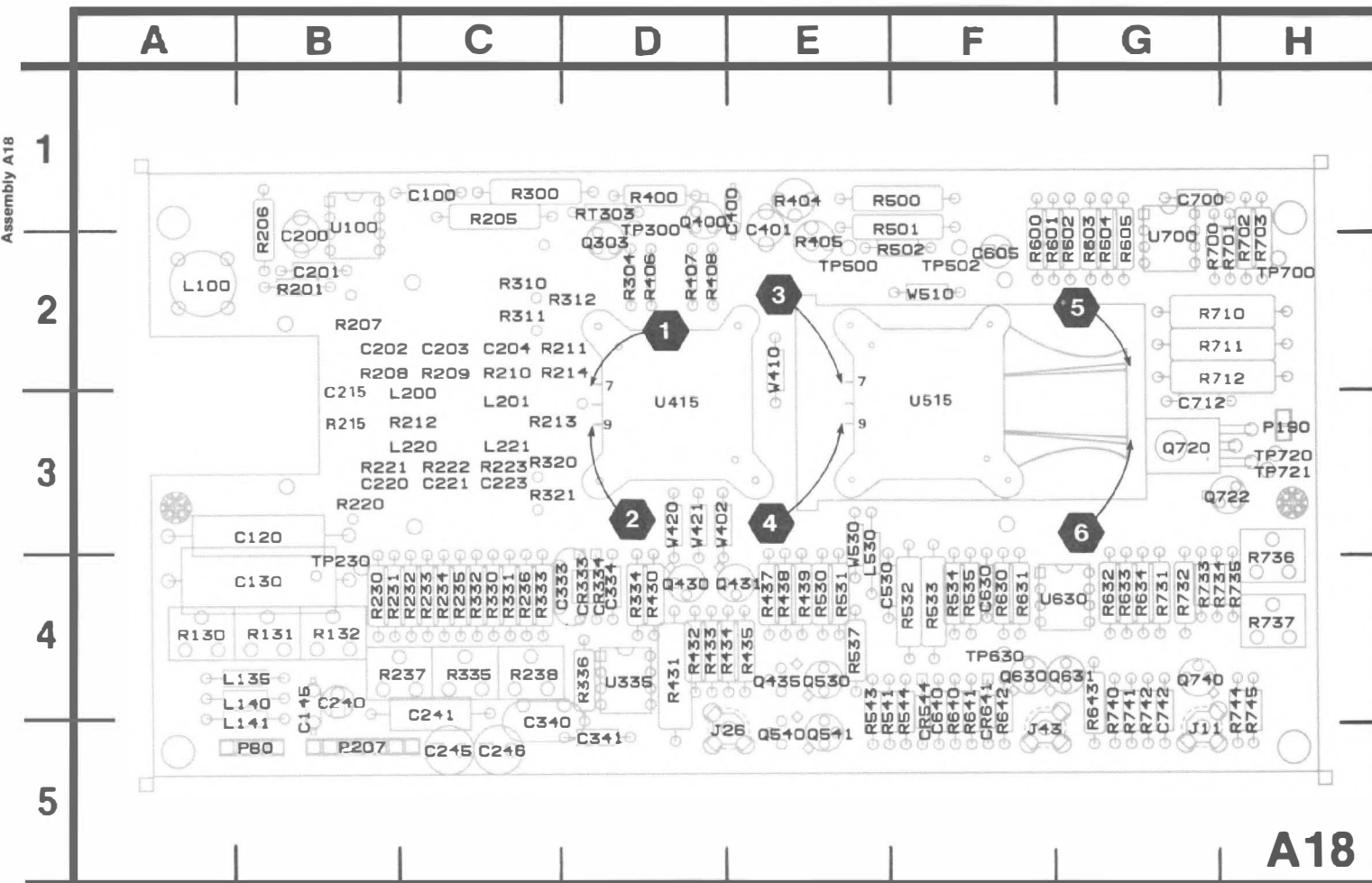

A18

Figure 8-12. A18—Vertical Amplifier circuit board assembly.

4693-811

**A18
VERTICAL AMPLIFIER
BOARD**
Shown in diag. 9

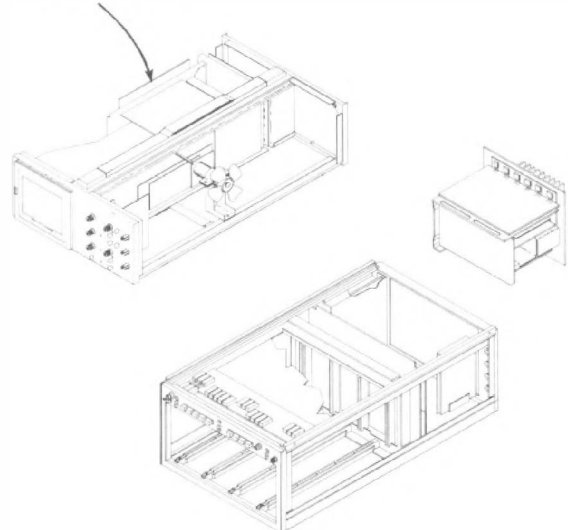

 **Static Sensitive Devices**
See Maintenance Section

COMPONENT NUMBER EXAMPLE

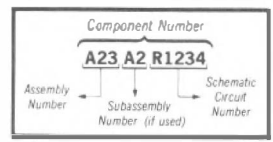

Chassis-mounted components have no Assembly Number prefix—see end of Replaceable Electrical Parts List

VERTICAL AMPLIFIER DIAGRAM 9

ASSEMBLY A18

| CIRCUIT NUMBER | SCHEM LOCATION | BOARD LOCATION | CIRCUIT NUMBER | SCHEM LOCATION | BOARD LOCATION | CIRCUIT NUMBER | SCHEM LOCATION | BOARD LOCATION | CIRCUIT NUMBER | SCHEM LOCATION | BOARD LOCATION | CIRCUIT NUMBER | SCHEM LOCATION | BOARD LOCATION |
|----------------|----------------|----------------|----------------|----------------|----------------|----------------|----------------|----------------|----------------|----------------|----------------|----------------|----------------|----------------|
| C100 | C4 | C1 | L135 | F4 | B4 | R220 | B2 | B3 | R439 | F2 | E4 | R735 | G3 | H4 |
| C120 | C2 | B3 | L140 | F4 | B4 | R221 | B3 | B3 | R500 | D2 | F1 | R736 | B4 | H4 |
| C130 | C2 | B4 | L141 | F4 | B5 | R222 | B3 | C3 | R501 | D3 | F1 | R737 | A3 | H4 |
| C145 | F4 | B4 | L200 | B2 | C3 | R223 | B3 | C3 | R502 | F2 | F2 | R740 | B4 | G4 |
| C200 | D2 | B2 | L201 | B2 | C3 | R230 | C2 | B4 | R530 | F2 | E4 | R741 | A4 | G4 |
| C201 | D2 | B2 | L220 | B2 | C3 | R231 | C2 | B4 | R530 | G2 | E4 | R742 | A3 | G4 |
| C202 | B1 | B2 | L221 | B2 | C3 | R232 | C2 | C4 | R531 | F2 | E4 | R742 | A4 | G4 |
| C203 | B1 | C2 | L530 | G2 | ■ | R233 | C2 | C4 | R532 | B3 | F4 | R744 | A3 | H4 |
| C204 | B1 | C2 | | | | R234 | C2 | C4 | R533 | F2 | F4 | R745 | A3 | H4 |
| C215 | B2 | B2 | P190 | G3 | H3 | R235 | D2 | C4 | R534 | B3 | F4 | | | |
| C220 | B3 | B3 | P207 | F4 | B5 | R236 | D2 | C4 | R535 | B3 | F4 | RT303 | D2 | D1 |
| C221 | B3 | C3 | | | | R237 | C2 | B4 | R537 | B4 | E4 | | | |
| C223 | B3 | C3 | Q303 | D2 | D2 | R238 | D2 | C4 | R541 | A4 | E4 | TP230 | C2 | B4 |
| C240 | F4 | B4 | Q400 | D2 | D1 | R300 | D2 | C1 | R543 | A4 | E4 | TP300 | D2 | D1 |
| C241 | C2 | C4 | Q430 | B3 | D4 | R304 | E2 | D2 | R544 | A4 | F4 | TP500 | F2 | E2 |
| C245 | F4 | C5 | Q431 | B4 | E4 | R310 | B4 | C2 | R600 | F2 | F2 | TP502 | F2 | F2 |
| C246 | F4 | C5 | Q435 | B3 | E4 | R311 | C2 | C2 | R601 | F2 | F2 | TP630 | B4 | F4 |
| C333 | D2 | C4 | Q530 | B4 | F4 | R312 | E2 | D2 | R602 | F2 | G2 | TP700 | E3 | H2 |
| C334 | C2 | D4 | Q540 | A4 | E5 | R320 | B3 | C3 | R603 | F2 | G2 | TP720 | G3 | H3 |
| C340 | D2 | C5 | Q541 | A4 | E5 | R321 | C2 | C3 | R604 | F2 | G2 | TP721 | G3 | H3 |
| C341 | D4 | D5 | Q630 | B3 | F4 | R330 | C2 | C4 | R605 | F2 | G2 | | | |
| C400 | E2 | E1 | Q631 | B4 | G4 | R331 | D2 | C4 | R630 | B4 | F4 | U100 | C4 | B1 |
| C401 | D2 | E1 | Q720 | G3 | G3 | R332 | D2 | C4 | R631 | B4 | F4 | U100 | D2 | B1 |
| C530 | G2 | E4 | Q722 | G3 | H3 | R333 | D2 | C4 | R632 | B3 | G4 | U335 | C2 | D4 |
| C605 | F3 | F2 | Q740 | A4 | G4 | R334 | C2 | D4 | R633 | A3 | G4 | U335 | D3 | D4 |
| C630 | B3 | F4 | | | | R335 | D2 | C4 | R634 | A3 | G4 | U515 | F1 | F3 |
| C640 | A4 | F4 | R130 | C2 | A4 | R336 | C2 | D4 | R640 | A4 | F4 | U630 | B3 | G4 |
| C700 | D4 | G1 | R131 | C2 | B4 | R400 | D2 | D1 | R641 | A3 | F4 | U630 | C3 | G4 |
| C712 | F4 | G3 | R132 | C2 | B4 | R404 | E2 | E1 | R642 | B4 | F4 | U700A | F2 | G2 |
| C742 | A4 | G5 | R201 | D2 | B2 | R405 | D2 | E2 | R643 | B4 | G4 | U700B | E3 | G2 |
| | | | R205 | D2 | C1 | R406 | E3 | D2 | R700 | E3 | G2 | U700 | D4 | G2 |
| CR333 | C2 | D4 | R206 | D2 | B1 | R407 | E2 | D2 | R701 | E3 | H2 | | | |
| CR334 | C2 | D4 | R207 | B2 | B2 | R408 | E2 | D2 | R702 | E3 | H2 | W402 | E3 | D3 |
| CR544 | A4 | F4 | R208 | B1 | B2 | R430 | B3 | D4 | R703 | E3 | H2 | W410 | F2 | E2 |
| CR641 | A3 | F4 | R209 | B1 | C2 | R431 | B4 | D4 | R710 | F3 | H2 | W420 | F2 | D3 |
| | | | R210 | B1 | C2 | R432 | B3 | D4 | R711 | F3 | H2 | W421 | F2 | D3 |
| J11 | A3 | G5 | R211 | B2 | D2 | R433 | B3 | D4 | R712 | F4 | H2 | W510 | F3 | F2 |
| J26 | A4 | E5 | R212 | B2 | C3 | R434 | B4 | D4 | R731 | G3 | G4 | W530 | F2 | E3 |
| J43 | A4 | F5 | R213 | B2 | C3 | R435 | B4 | E4 | R732 | G3 | G4 | | | |
| | | | R214 | B2 | D2 | R437 | B4 | E4 | R733 | G3 | G4 | | | |
| L100 | B2 | A2 | R215 | B2 | B3 | R438 | F2 | E4 | R734 | G3 | G4 | | | |

CHASSIS MOUNTED PARTS

| CIRCUIT NUMBER | SCHEM LOCATION | BOARD LOCATION | CIRCUIT NUMBER | SCHEM LOCATION | BOARD LOCATION | CIRCUIT NUMBER | SCHEM LOCATION | BOARD LOCATION | CIRCUIT NUMBER | SCHEM LOCATION | BOARD LOCATION |
|----------------|----------------|----------------|----------------|----------------|----------------|----------------|----------------|----------------|----------------|----------------|----------------|
| A31 | G1 | CHASSIS | C81 | H2 | CHASSIS | L82 | H2 | CHASSIS | R82 | G2 | CHASSIS |
| A31 | G3 | CHASSIS | | | | | | | R83 | G2 | CHASSIS |
| | | | L81 | H2 | CHASSIS | R81 | G2 | CHASSIS | | | |

VOLTAGE AND WAVEFORM CONDITIONS

The voltages and waveforms shown were obtained with the 7904A front panel variable controls at midrange except B INTENSITY control is set at minimum; VERTICAL MODE, LEFT; TRIGGER SOURCE, VERT MODE; HORIZONTAL MODE, B; CALIBRATOR, 4 V; READOUT INTENSITY, OFF.

Voltage Conditions. The voltages shown on the diagram were obtained using a digital multimeter with a 10 M Ω input impedance (TEKTRONIX DM 501A Digital Multimeter or TEKTRONIX 7D13A Digital Multimeter used with a readout-equipped 7000-series oscilloscope). Voltages are taken with no signal input and with the vertical trace centered.

Waveform Conditions. The waveforms shown below were obtained using a test oscilloscope system with 10 M Ω input impedance and at least 60 MHz bandwidth. (TEKTRONIX 7603 Oscilloscope, 7B53A Time Base, and 7A13 Differential Comparator equipped with a 10X probe.) A 7A-series vertical amplifier plug-in was installed in the 7904A LEFT VERT compartment and a 7B-series time base plug-in in the 7904A B HORIZ compartment. The vertical amplifier was set for a centered, 6 to 8 division display on the 7904A with the CALIBRATOR output fed to the vertical amplifier input. The 7904A oscilloscope time base was externally triggered with the CALIBRATOR signal.

Voltages shown near the waveform are display center dc levels.

1

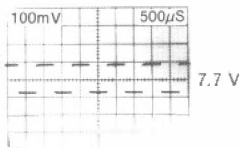

2

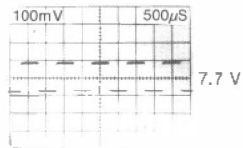

3

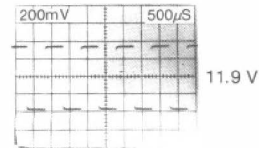

4

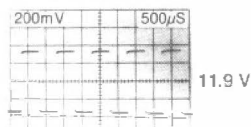

5

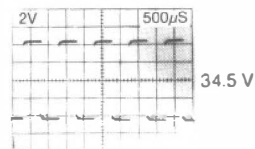

6

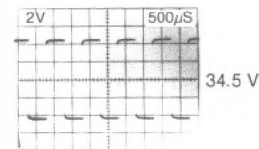

A

B

C

D

E

F

G

VOLTAGE & WAVEFORM CONDITIONS

1

2

3

4

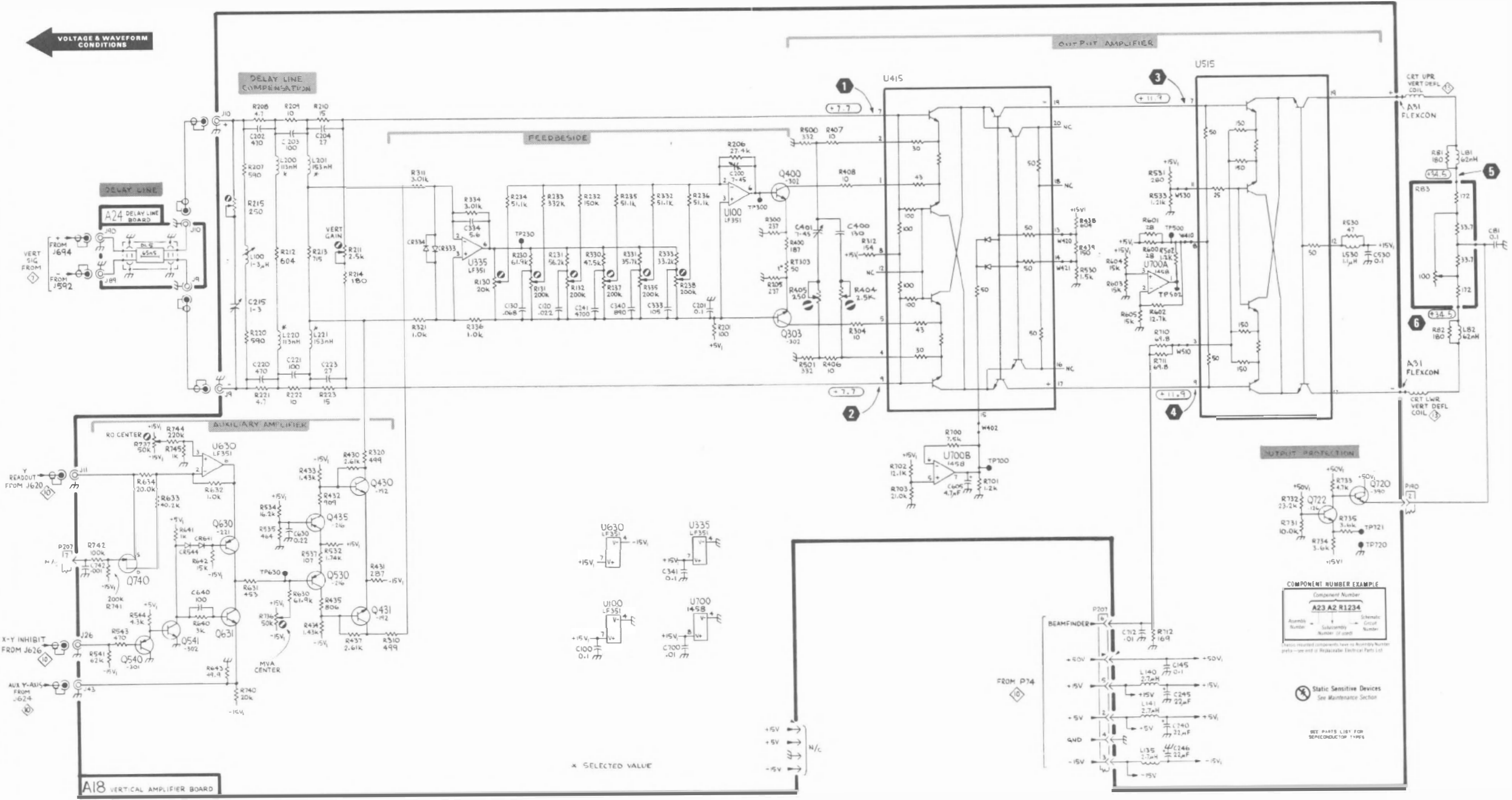

COMPONENT NUMBER EXAMPLE

| Company Number | Subassembly Number | Schematic Number |
|----------------|--------------------|------------------|
| A23 | A2 | R1234 |

Always insert components from the Assembly Number into the end of the Replaceable Electrical Parts List

Static Sensitive Devices See Maintenance Section

SEE PARTS LIST FOR REPRODUCTION TYPES

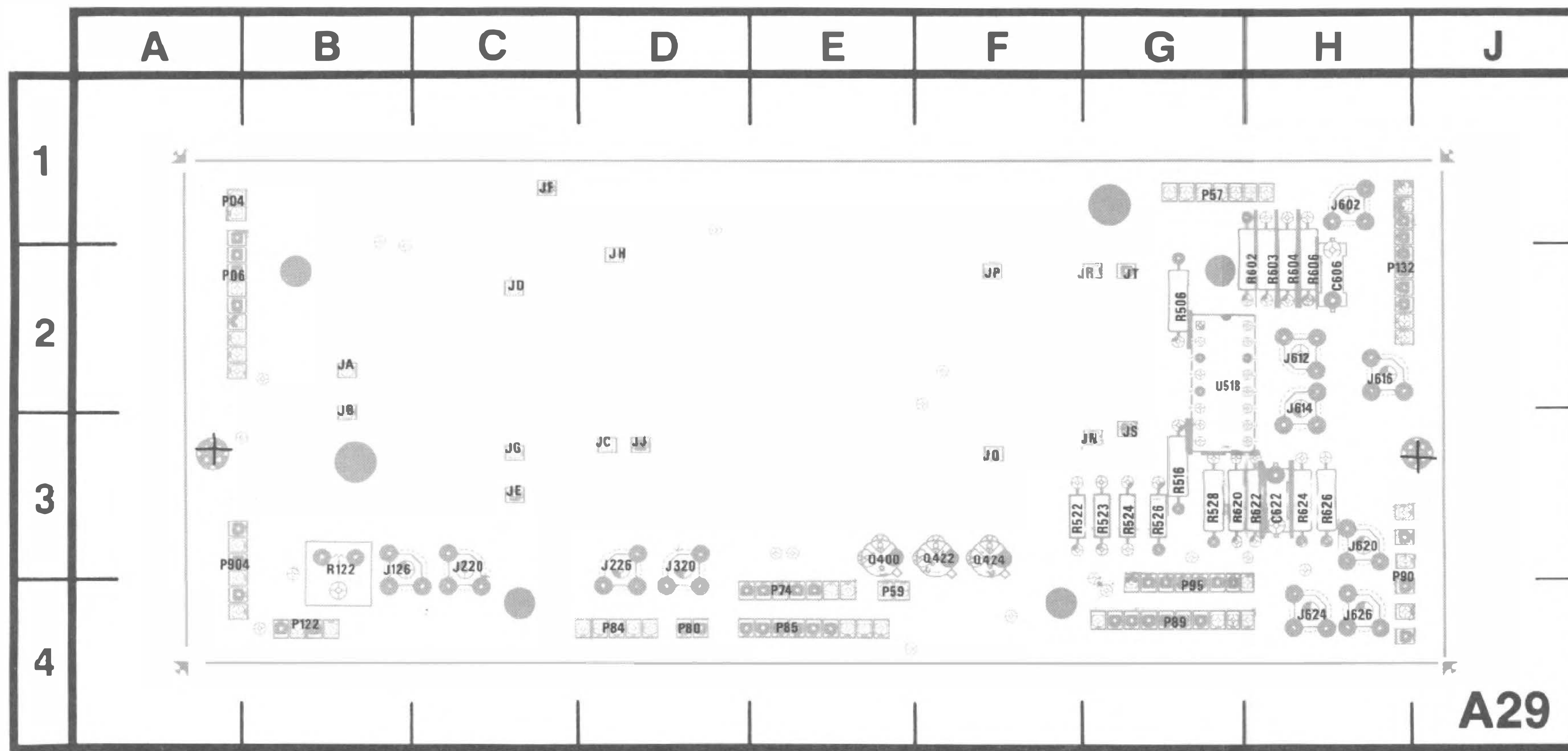

Figure 8-13. A29—Horizontal Interface circuit board assembly.

4593-812

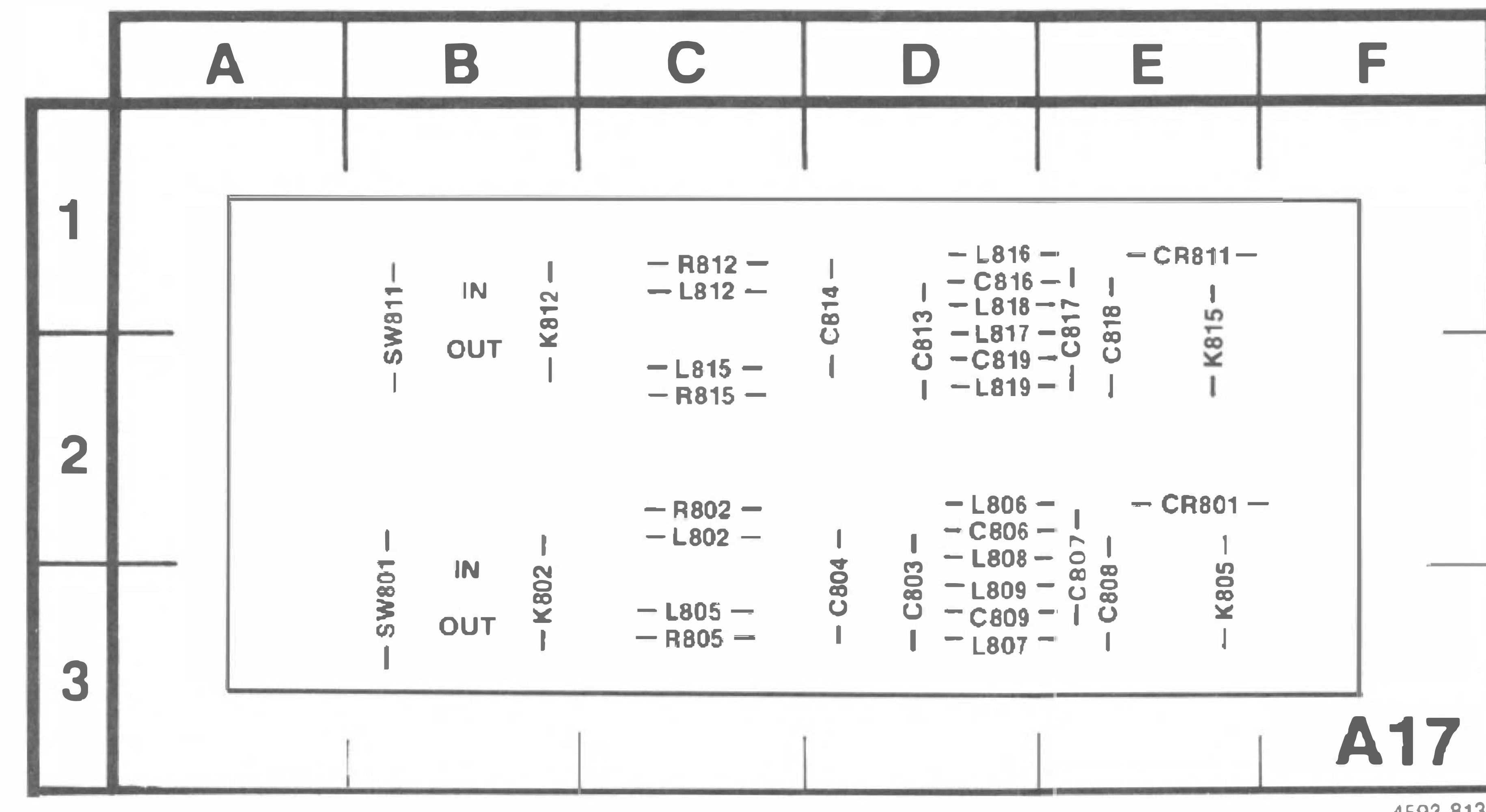
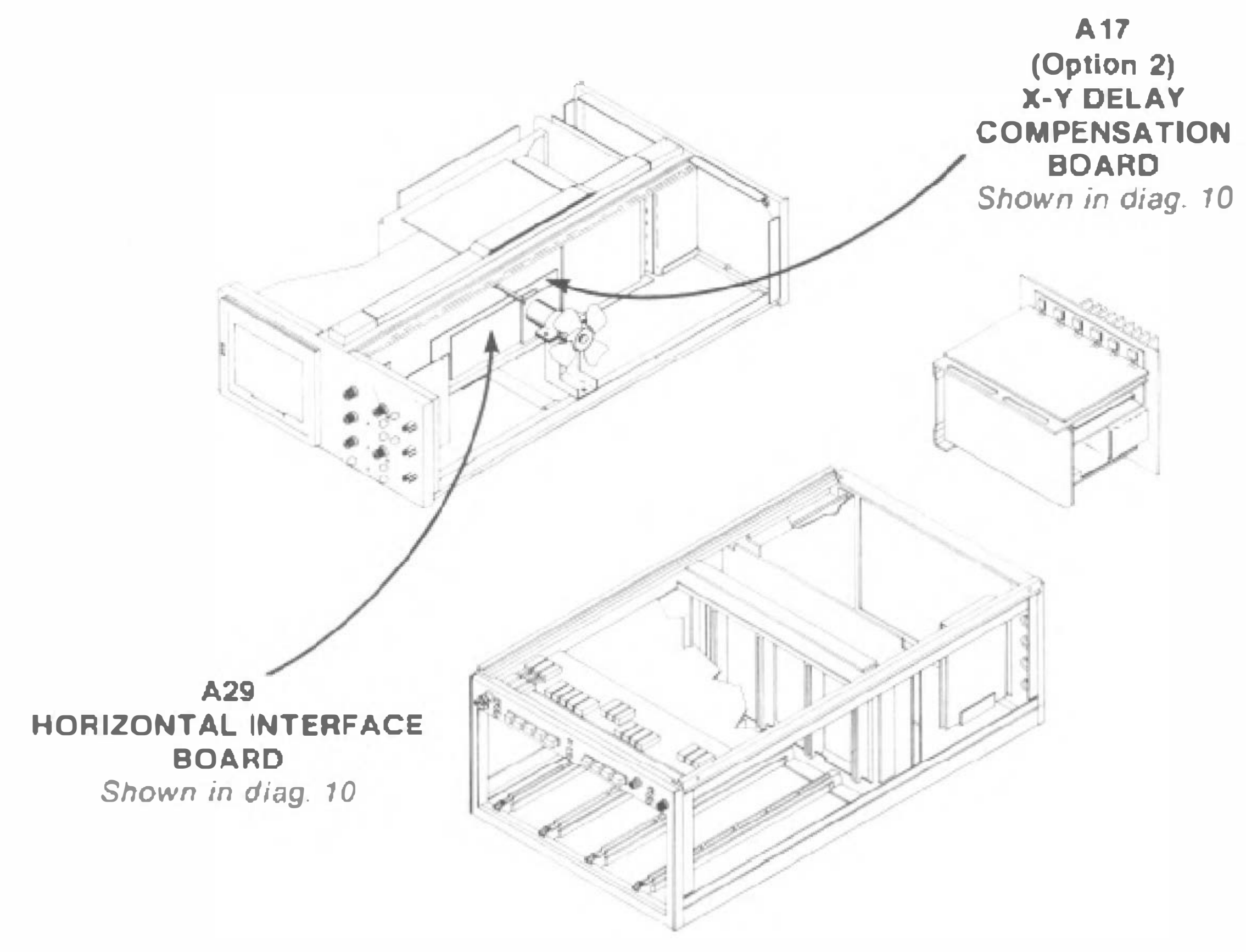

Figure 8-14. A17—X-Y Delay Compensation (Option 2) circuit board assembly.

4593-813A



⊗ Static Sensitive Devices
See Maintenance Section

COMPONENT NUMBER EXAMPLE

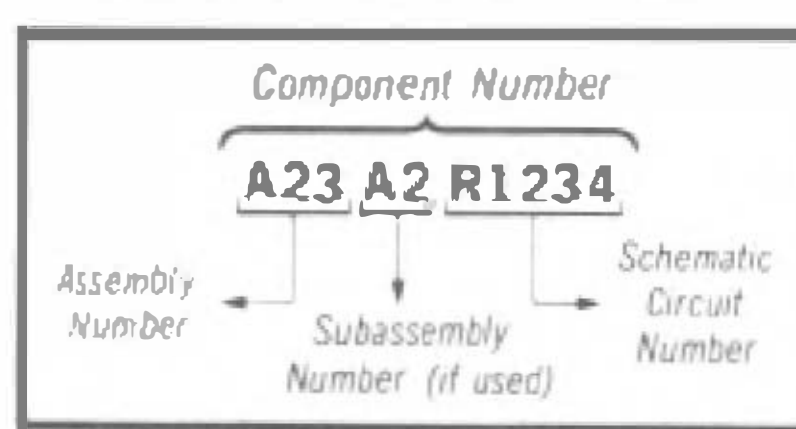

Chassis-mounted components have no Assembly Number prefix—see end of Replaceable Electrical Parts List.

HORIZONTAL INTERFACE DIAGRAM



ASSEMBLY A17

| CIRCUIT NUMBER | SCHEM LOCATION | BOARD LOCATION | CIRCUIT NUMBER | SCHEM LOCATION | BOARD LOCATION |
|----------------|----------------|----------------|----------------|----------------|----------------|
| C803 | F4 | D3 | L802 | F4 | C2 |
| C804 | F4 | D3 | L805 | F4 | C3 |
| C806 | G4 | D2 | L806 | G4 | D2 |
| C807 | G4 | E2 | L807 | F4 | D3 |
| C808 | G4 | E3 | L808 | F4 | D2 |
| C809 | G5 | D3 | L809 | G4 | D3 |
| C813 | F5 | D2 | L812 | F5 | C1 |
| C814 | F5 | D1 | L815 | F5 | C2 |
| C816 | G5 | D1 | L816 | G5 | D1 |
| C817 | G5 | E1 | L817 | F5 | D1 |
| C818 | G5 | E1 | L818 | F5 | D1 |
| C819 | G6 | D2 | L819 | G5 | D2 |
| CR801 | F4 | E2 | R802 | F4 | C2 |
| CR811 | F6 | E1 | R805 | F5 | C3 |
| K802 | F4 | B3 | RB12 | F5 | C1 |
| K805 | G4 | E3 | R815 | F6 | C2 |
| K812 | F5 | B1 | S801 | E4 | B3 |
| K815 | G5 | E2 | SB11 | E6 | B1 |

ASSEMBLY A29

| CIRCUIT NUMBER | SCHEM LOCATION | BOARD LOCATION | CIRCUIT NUMBER | SCHEM LOCATION | BOARD LOCATION |
|----------------|----------------|----------------|----------------|----------------|----------------|
| C606 | F1 | H2 | P132 | C2 | H2 |
| C622 | F2 | H3 | P904 | C1 | A3 |
| J126 | D2 | B3 | Q400 | C4 | E3 |
| J220 | D2 | C3 | Q422 | B5 | F3 |
| J226 | D1 | D3 | Q424 | B5 | F3 |
| J320 | D2 | D3 | R122 | B1 | B3 |
| J602 | C4 | H1 | R506 | F1 | G2 |
| J614 | G2 | H2 | R516 | F2 | G3 |
| J616 | C6 | H2 | R522 | B5 | F3 |
| J620 | C6 | H3 | R523 | B5 | G3 |
| J624 | C5 | H4 | R524 | B5 | G3 |
| J626 | C4 | H4 | R526 | B4 | G3 |
| P4 | A2 | A1 | R528 | F2 | G3 |
| P6 | A1 | A2 | R602 | F1 | H2 |
| P57 | C2 | G1 | R603 | F1 | H2 |
| P59 | C4 | E4 | R604 | F1 | H2 |
| P74 | C5 | E4 | R606 | F1 | H2 |
| P80 | C6 | D4 | R620 | F2 | G3 |
| P84 | D3 | D4 | R622 | F2 | H3 |
| P89 | A3 | G4 | R624 | G3 | H3 |
| P90 | A5 | H3 | R626 | F2 | H3 |
| P95 | C3 | G4 | U518 | F1 | G2 |
| P122 | C1 | B4 | | | |

CHASSIS MOUNTED PARTS

| CIRCUIT NUMBER | SCHEM LOCATION | BOARD LOCATION |
|----------------|----------------|----------------|
| A19 | E3 | CHASSIS |

1

2

3

4

5

6

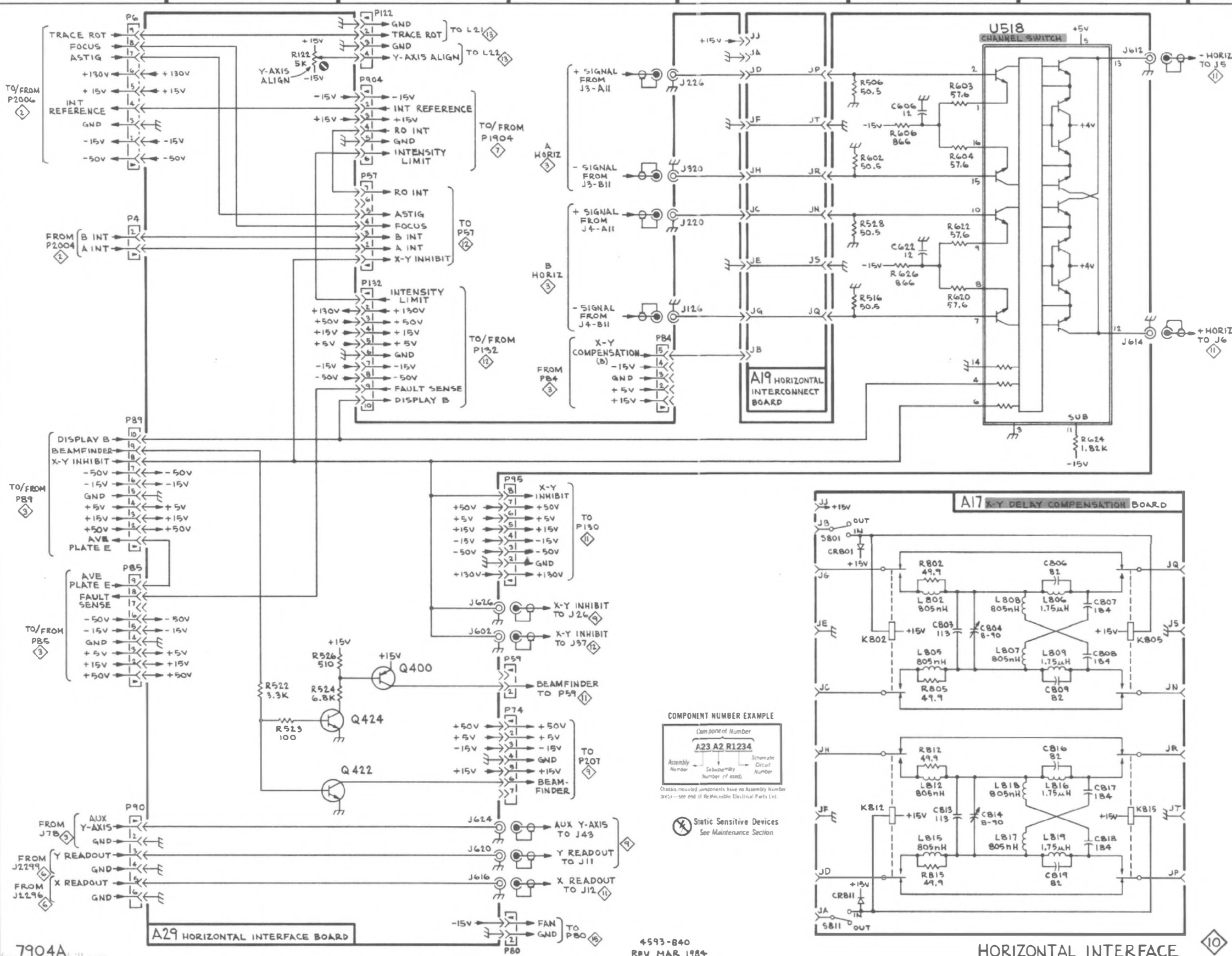

COMPONENT NUMBER EXAMPLE

Component Number: A23 A2 R1234

Assembly Number: A23
Subassembly Number: A2
Schema Circut Number: R1234

Chassis-mounted components have no Assembly Number (see end of Releccable Electrical Parts List)

⊗ Static Sensitive Devices
See Maintenance Section

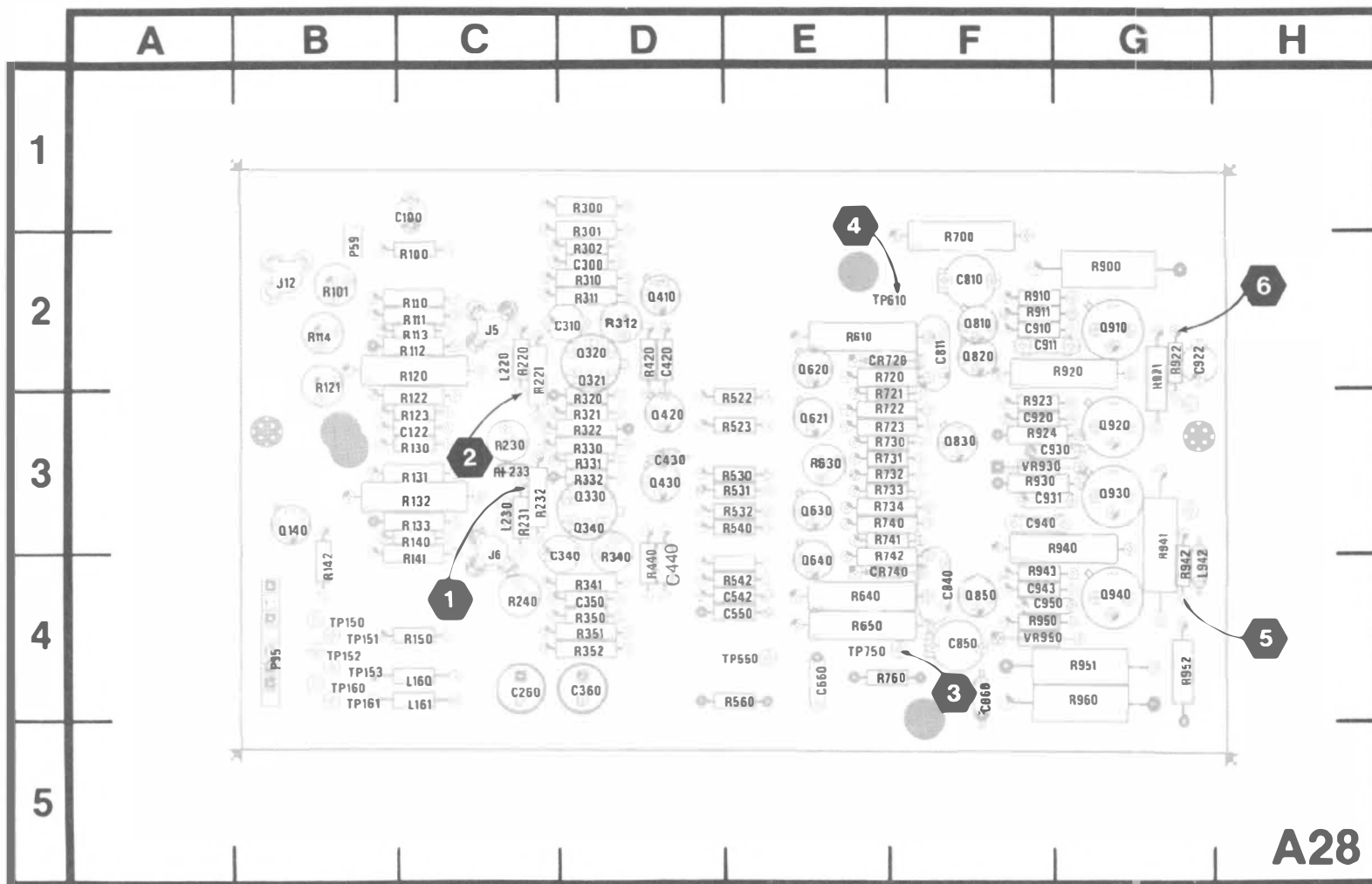
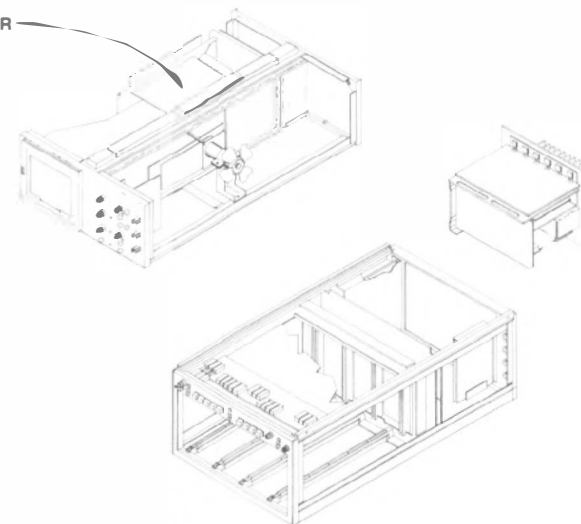

Figure 8-15. A28—Horizontal Amplifier circuit board assembly.

4593-814A

A28
HORIZONTAL AMPLIFIER
BOARD
Shown on diag. 11



 Static Sensitive Devices
See Maintenance Section

COMPONENT NUMBER EXAMPLE

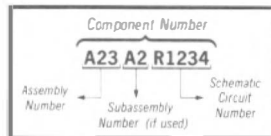

Chassis-mounted components have no Assembly Number prefix—see end of Replaceable Electrical Parts List

HORIZONTAL AMPLIFIER DIAGRAM

11

ASSEMBLY A28

| CIRCUIT NUMBER | SCHEM LOCATION | BOARD LOCATION | CIRCUIT NUMBER | SCHEM LOCATION | BOARD LOCATION | CIRCUIT NUMBER | SCHEM LOCATION | BOARD LOCATION |
|----------------|----------------|----------------|----------------|----------------|----------------|----------------|----------------|----------------|
| C100 | B4 | C1 | Q810 | F1 | F2 | R531 | E3 | E3 |
| C122 | A2 | C3 | Q820 | F2 | F2 | R532 | D4 | E3 |
| C260 | A5 | C4 | Q830 | E4 | F3 | R540 | D4 | E3 |
| C300 | C1 | D2 | Q850 | F4 | F4 | R542 | E2 | E4 |
| C310 | B2 | D2 | Q910 | G1 | G2 | R560 | A5 | E4 |
| C340 | B3 | D4 | Q920 | G2 | G3 | R610 | E1 | E2 |
| C350 | C3 | D4 | Q930 | G4 | G3 | R630 | E2 | E3 |
| C360 | A5 | D4 | Q940 | G4 | G4 | R640 | E4 | E4 |
| C420 | C1 | D2 | | | | R650 | E3 | E4 |
| C430 | D2 | D3 | R100 | B4 | C2 | R700 | E2 | F2 |
| C440 | C4 | D4 | R101 | A1 | B2 | R720 | E2 | F2 |
| C542 | A5 | E4 | R110 | A1 | C2 | R721 | E2 | F3 |
| C550 | B3 | E4 | R111 | A1 | C2 | R722 | E1 | F3 |
| C660 | A5 | E4 | R112 | A2 | C2 | R723 | E2 | F3 |
| C810 | E2 | F2 | R113 | B1 | C2 | R730 | E4 | F3 |
| C811 | E2 | F2 | R114 | B3 | B2 | R731 | E4 | F3 |
| C840 | E3 | F4 | R120 | A2 | C2 | R732 | E4 | F3 |
| C850 | E3 | F4 | R121 | A3 | B2 | R733 | E4 | F3 |
| C860 | B4 | F4 | R122 | A2 | C3 | R734 | E3 | F3 |
| C910 | G1 | F2 | R123 | A2 | C3 | R740 | E4 | F3 |
| C911 | F1 | F2 | R130 | B3 | C3 | R741 | E3 | F3 |
| C920 | G2 | F3 | R131 | A3 | C3 | R742 | E3 | F3 |
| C922 | G2 | G2 | R132 | A4 | C3 | R760 | A4 | E4 |
| C930 | G3 | G3 | R133 | A3 | C3 | R900 | F2 | G2 |
| C931 | G4 | F3 | R140 | B4 | C3 | R910 | F2 | F2 |
| C940 | F5 | F3 | R141 | A4 | C4 | H911 | G1 | F2 |
| C943 | G4 | F4 | R142 | B3 | B4 | R920 | F1 | G2 |
| C950 | F4 | F4 | R150 | A5 | C4 | R921 | G2 | G2 |
| | | | R220 | B1 | C2 | R922 | G2 | G2 |
| CR720 | E2 | F2 | R221 | C1 | C2 | R923 | F2 | F3 |
| CR740 | E3 | F4 | R230 | C1 | C3 | R924 | G2 | F3 |
| | | | R231 | B4 | C3 | R930 | G4 | F3 |
| J5 | A1 | C2 | R232 | C3 | C3 | R940 | F4 | G3 |
| J6 | A4 | C4 | R240 | C3 | C4 | R941 | G4 | G3 |
| J12 | A1 | B2 | R300 | D2 | D1 | R942 | G4 | G4 |
| | | | R301 | B2 | D1 | R943 | G4 | F4 |
| L160 | A5 | C4 | R302 | C1 | D2 | R950 | F4 | F4 |
| L161 | A5 | C4 | R310 | B1 | D2 | R951 | F4 | G4 |
| L220 | A1 | C2 | R311 | C1 | D2 | R952 | G3 | G4 |
| L230 | A4 | C3 | R312 | B2 | D2 | R960 | F3 | G4 |
| L942 | G4 | G4 | R320 | B2 | C3 | | | |
| | | | R321 | D2 | D3 | RT233 | C3 | C3 |
| P59 | A4 | B2 | R322 | C1 | D3 | | | |
| | | | R330 | C3 | D3 | TP150 | A5 | B4 |
| Q140 | B3 | B3 | R331 | C3 | D3 | TP151 | A5 | B4 |
| Q320 | C1 | D2 | R332 | B3 | D3 | TP152 | A5 | B4 |
| Q321 | C1 | D2 | R340 | B3 | D4 | TP153 | A5 | B4 |
| Q330 | C3 | D3 | R341 | C3 | D4 | TP160 | A5 | B4 |
| Q340 | C4 | D3 | R350 | C3 | D4 | TP161 | A4 | B4 |
| Q410 | D3 | D2 | R351 | B4 | D4 | TP610 | E1 | F2 |
| Q420 | D1 | D3 | R352 | B3 | D4 | TP750 | E4 | E4 |
| Q430 | D4 | D3 | R420 | C1 | D2 | | | |
| Q620 | E1 | E2 | R440 | C4 | D4 | VR930 | G3 | F3 |
| Q621 | E2 | E3 | R522 | D1 | E3 | VR950 | F4 | F4 |
| Q630 | E3 | E3 | R523 | D1 | E3 | | | |
| Q640 | E4 | E4 | R530 | D2 | E3 | | | |

VOLTAGE AND WAVEFORM CONDITIONS

The voltages and waveforms shown were obtained with the 7904A front panel variable controls at midrange except A INTENSITY control is set at minimum; voltmeter ground is connected to chassis ground; VERTICAL MODE, LEFT; A & B TRIGGER SOURCE, VERT MODE; HORIZONTAL MODE, A; READOUT, OFF.

Voltage Conditions. The voltages shown on the diagram were obtained using a digital multimeter with a 10 M Ω input impedance (TEKTRONIX DM 501A Digital Multimeter or TEKTRONIX 7D13A Digital Multimeter used with a readout-equipped 7000-series oscilloscope).

Waveform Conditions. The waveforms shown below were obtained using a test oscilloscope system with 10 M Ω input impedance and at least 60 MHz bandwidth. (TEKTRONIX 7603 Oscilloscope, 7B53A Time Base, and 7A13 Differential Comparator equipped with a 10X probe.) A 7B-series time base plug-in was installed in the 7904A A HORIZ. The 7904A Oscilloscope time base was set for internal auto triggering and a 1 ms/div sweep rate.

Voltages shown near the waveforms are display center dc levels.

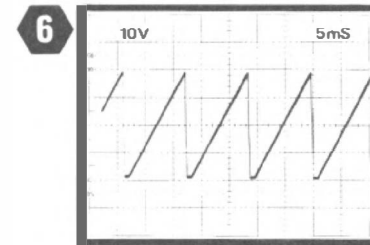
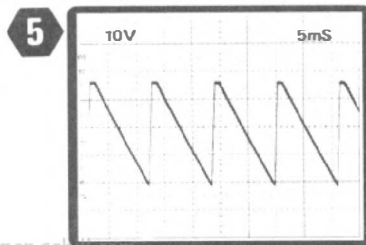
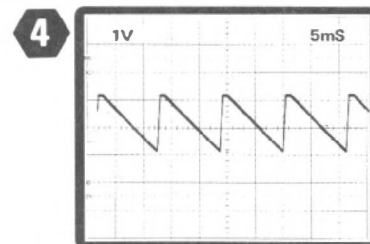
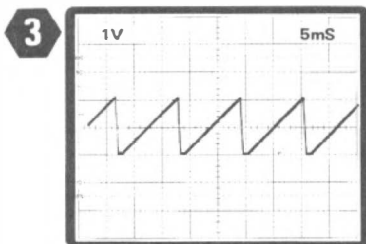
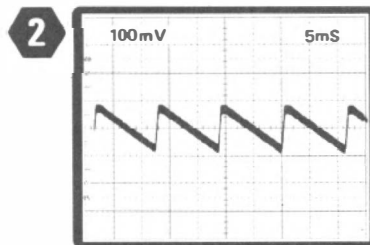
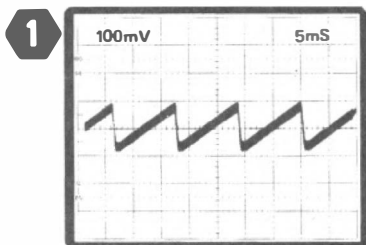

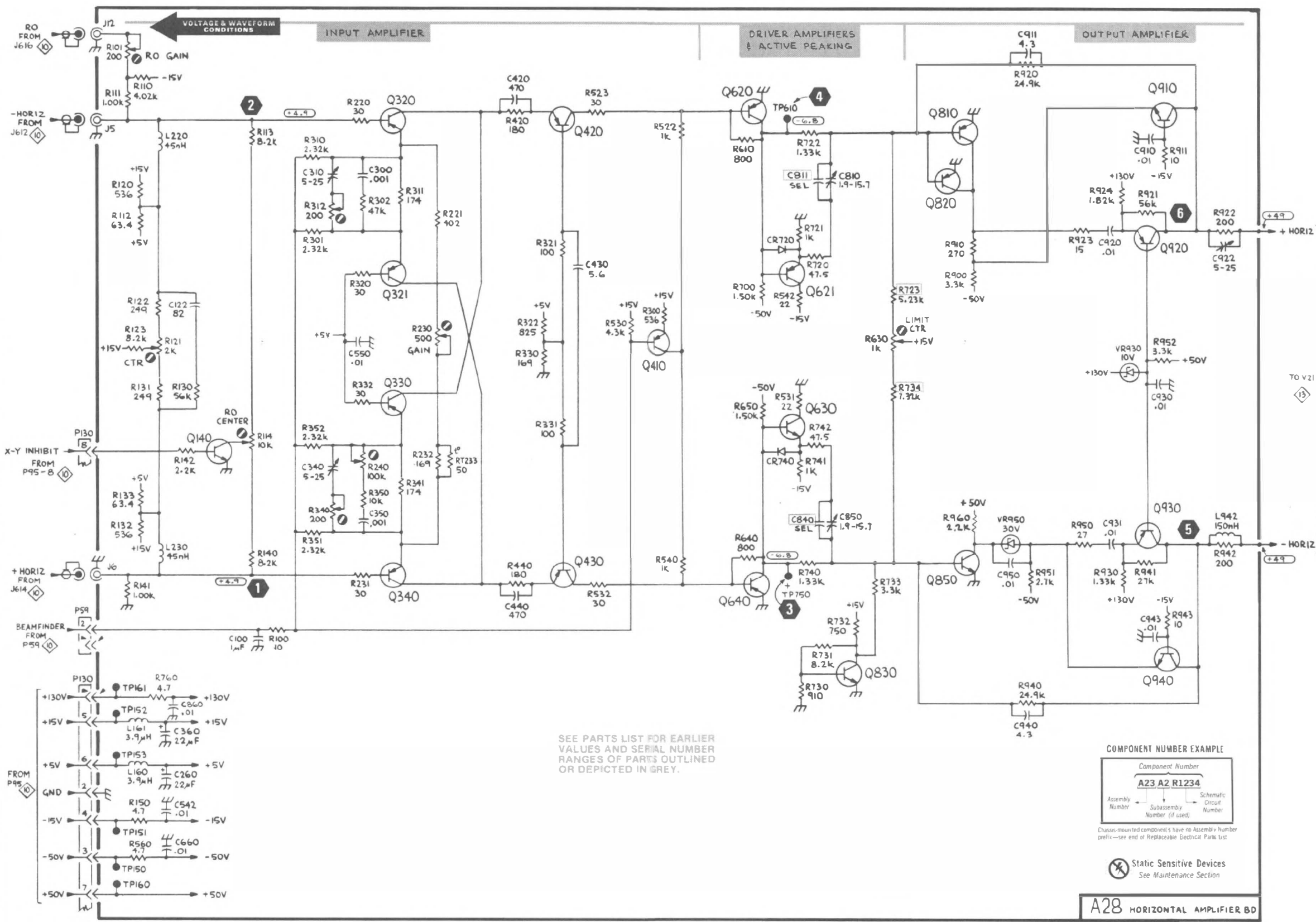
A**B****C****D****E****F****G**

SEE PARTS LIST FOR EARLIER VALUES AND SERIAL NUMBER RANGES OF PARTS OUTLINED OR DEPICTED IN GREY.

COMPONENT NUMBER EXAMPLE

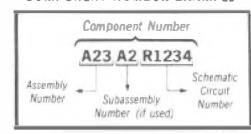

Class-mounted components have no Assembly Number prefix—see end of Replaceable Electrical Parts List

Static Sensitive Devices See Maintenance Section

A28 HORIZONTAL AMPLIFIER BD

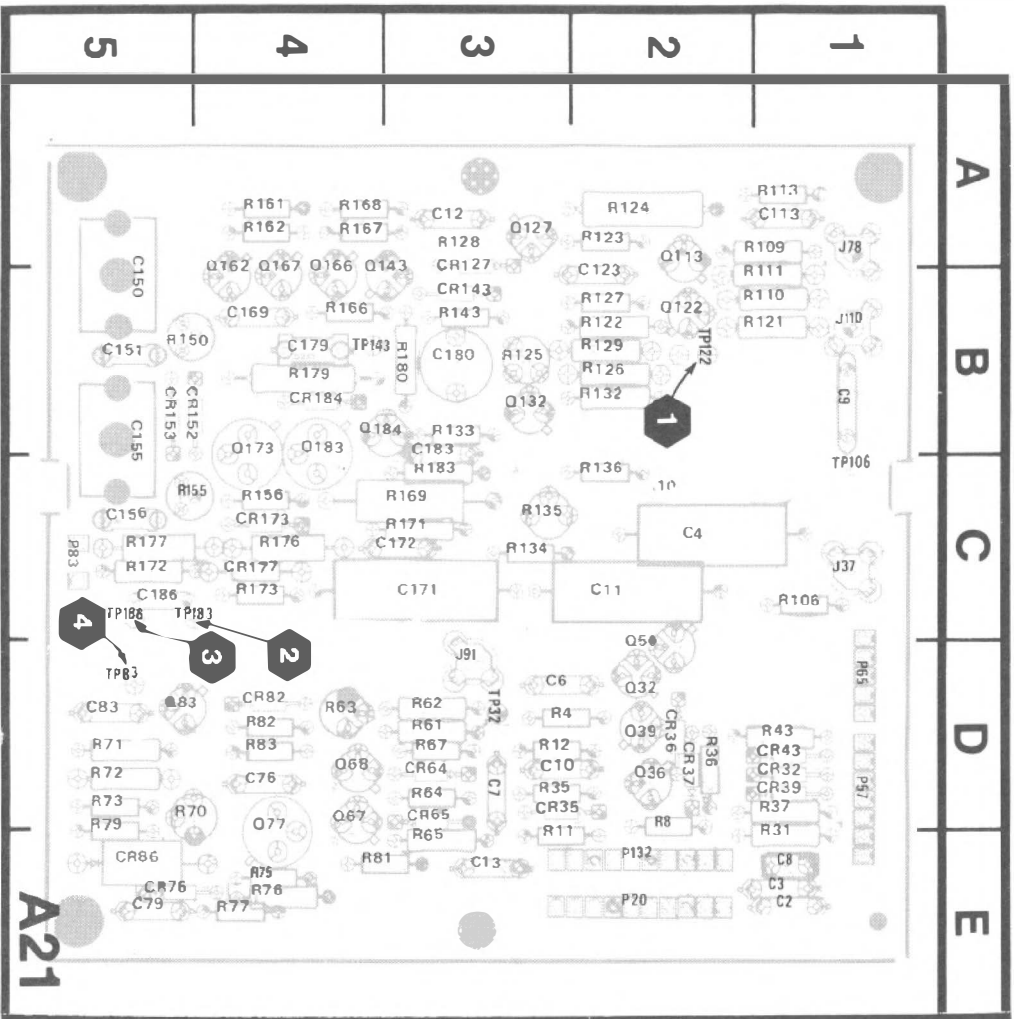
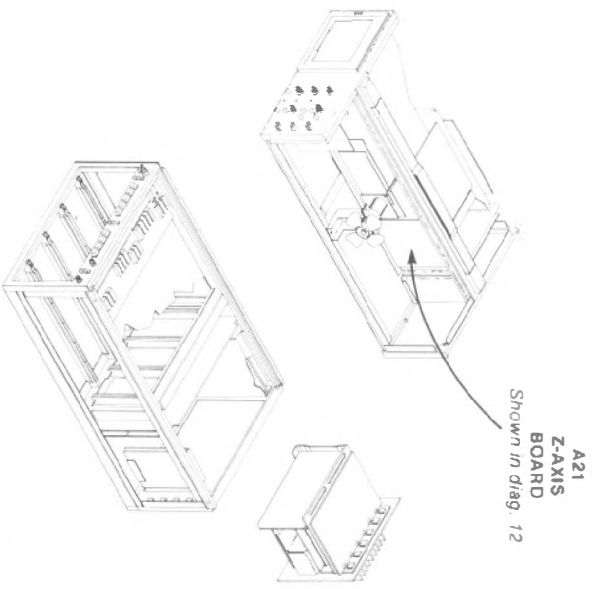

Figure 8-16. A21—Z-Axis circuit board assembly.

4593-815



Z-AXIS & FOCUS AMPLIFIER DIAGRAM



ASSEMBLY A21

| CIRCUIT NUMBER | SCHEM LOCATION | BOARD LOCATION | CIRCUIT NUMBER | SCHEM LOCATION | BOARD LOCATION | CIRCUIT NUMBER | SCHEM LOCATION | BOARD LOCATION |
|----------------|----------------|----------------|----------------|----------------|----------------|----------------|----------------|----------------|
| C2 | A2 | E1 | P20 | B1 | E2 | R75 | F2 | E4 |
| C3 | A2 | E1 | P57 | A2 | D1 | R76 | F1 | E4 |
| C4 | A2 | C2 | P57 | C1 | D1 | R77 | F1 | E4 |
| C6 | B2 | D3 | P57 | C2 | D1 | R79 | F1 | D5 |
| C7 | A3 | D3 | P65 | B2 | D1 | R81 | F2 | E3 |
| C8 | B3 | E1 | P65 | C2 | D1 | R82 | F2 | D4 |
| C9 | B3 | B1 | P83 | C1 | C5 | R83 | F2 | D4 |
| C10 | B3 | D3 | P83 | G2 | C5 | R101 | B4 | B1 |
| C11 | B3 | C2 | P132 | A1 | E2 | R109 | B4 | A1 |
| C12 | A3 | A3 | P132 | A4 | E2 | R110 | B4 | B1 |
| C13 | A3 | E3 | P132 | C1 | E2 | R111 | C4 | A1 |
| C76 | F2 | D4 | | | | R113 | C4 | A1 |
| C79 | F2 | E5 | Q32 | D1 | D2 | R121 | C4 | B1 |
| CB3 | F2 | D5 | Q36 | D1 | D2 | R122 | D4 | B2 |
| C101 | B4 | B2 | Q39 | D2 | D2 | R123 | D4 | A2 |
| C113 | A3 | A1 | Q50 | D2 | C2 | R124 | D4 | A2 |
| C123 | D4 | A2 | Q67 | E1 | D4 | R125 | D2 | B3 |
| C150 | F3 | B5 | Q68 | F1 | D4 | R126 | D4 | B2 |
| C151 | F3 | B5 | Q77 | F2 | D4 | R127 | D4 | B2 |
| C155 | F4 | B5 | QB3 | F2 | D5 | R128 | D4 | A3 |
| C156 | F3 | C5 | Q113 | C4 | A2 | R129 | D4 | B2 |
| C169 | F4 | B4 | Q122 | D4 | B2 | R132 | D2 | B2 |
| C171 | F5 | C3 | Q127 | D4 | A3 | R133 | D2 | B3 |
| C172 | F5 | C3 | Q132 | D2 | B3 | R134 | C3 | C3 |
| C179 | F5 | B4 | Q143 | E4 | A4 | R135 | C3 | C3 |
| C180 | E4 | B3 | Q162 | F3 | A4 | R136 | C3 | B2 |
| C183 | F6 | B3 | Q166 | F4 | A4 | R143 | E4 | B3 |
| C186 | G5 | C5 | Q167 | F4 | A4 | R150 | F3 | B5 |
| | | | Q173 | F5 | B4 | R155 | F3 | C4 |
| CR32 | D1 | D1 | Q183 | F5 | B4 | R156 | F4 | C4 |
| CR35 | C1 | D3 | Q184 | F6 | B4 | R161 | F3 | A4 |
| CR36 | D1 | D2 | | | | R162 | F3 | A4 |
| CR37 | D2 | D2 | R4 | A2 | D3 | R166 | E4 | B4 |
| CR39 | D2 | D1 | R8 | B3 | D2 | R167 | F4 | A4 |
| CR43 | C2 | D1 | R9 | B3 | C1 | R168 | F4 | A4 |
| CR64 | E1 | D3 | R11 | A3 | D3 | R169 | G4 | C3 |
| CR65 | E1 | D3 | R12 | A3 | D3 | R171 | E5 | C3 |
| CR76 | F1 | E5 | R31 | C1 | D1 | R172 | E5 | C5 |
| CRB2 | F2 | D4 | R35 | C1 | D3 | R173 | F5 | C4 |
| CRB6 | G2 | E5 | R36 | D1 | D2 | R176 | G4 | C4 |
| CR127 | D4 | A3 | R37 | C2 | D1 | R177 | G5 | C5 |
| CR143 | E4 | B3 | R43 | C2 | D1 | R179 | F5 | B4 |
| CR152 | F3 | B4 | R61 | E1 | D3 | R180 | E4 | B3 |
| CR153 | F3 | B5 | R62 | E1 | D3 | R183 | F5 | C3 |
| CR173 | F5 | C3 | R63 | E1 | D4 | | | |
| CR177 | F5 | C3 | R64 | E1 | D3 | TP32 | D1 | D3 |
| CR184 | G6 | B4 | R65 | E1 | D3 | TPB3 | G2 | D5 |
| | | | R67 | F1 | D3 | TP122 | C4 | B2 |
| J37 | C1 | C1 | R70 | F1 | D5 | TP143 | E4 | B4 |
| J7B | B4 | A1 | R71 | F1 | D5 | TP1B3 | G5 | C4 |
| J110 | B4 | B1 | R72 | F1 | D5 | TP1B6 | C1 | C5 |
| | | | R73 | F1 | D5 | | | |

VOLTAGE AND WAVEFORM CONDITIONS

The voltages and waveforms shown were obtained with the 7904A front panel variable controls at midrange except A and B INTENSITY controls are set at minimum; VERTICAL MODE, LEFT; TRIGGER SOURCE, VERT MODE; HORIZONTAL MODE, B; READOUT INTENSITY, OFF.

Voltage Conditions. The voltages shown on the diagram were obtained using a digital multimeter with a 10 M Ω input impedance (TEKTRONIX DM 501A Digital Multimeter installed in a TM 501 Power Module or TEKTRONIX 7D13A Digital Multimeter used with a readout-equipped 7000-series oscilloscope).

Waveform Conditions. The waveforms shown below were obtained using a test oscilloscope system with 10 M Ω input impedance, at least 60 MHz bandwidth and 10X probe (TEKTRONIX 7603 Oscilloscope, 7B92A Time Base, 7A13 Differential Comparator and P6063B Probe).

Waveforms 1, 2, and 3 conditions: 7B80 Time Base with controls set as follows: Time/Div (1 μ s); Triggering (P-P Auto, Ac, Int) installed in the B HORIZ compartment of the 7904A. The 7904A Oscilloscope B INTENSITY at midrange.

Waveform 4 conditions: Same as 1 above except the 7904A HORIZONTAL MODE was set to CHOP, A INTENSITY counterclockwise, and B INTENSITY clockwise.

Voltage shown near the waveforms are display center dc levels.

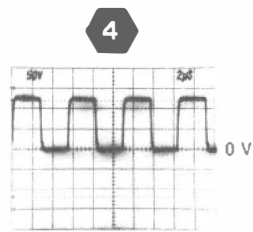
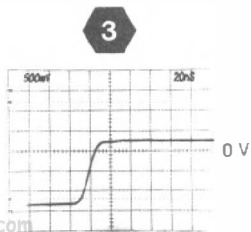
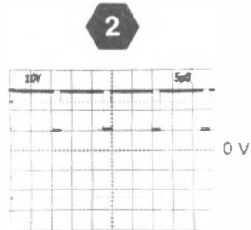
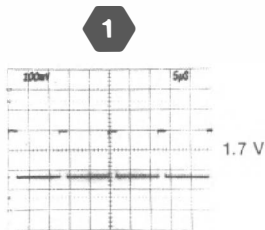

A

B

C

D

E

F

G

1

2

3

4

5

6

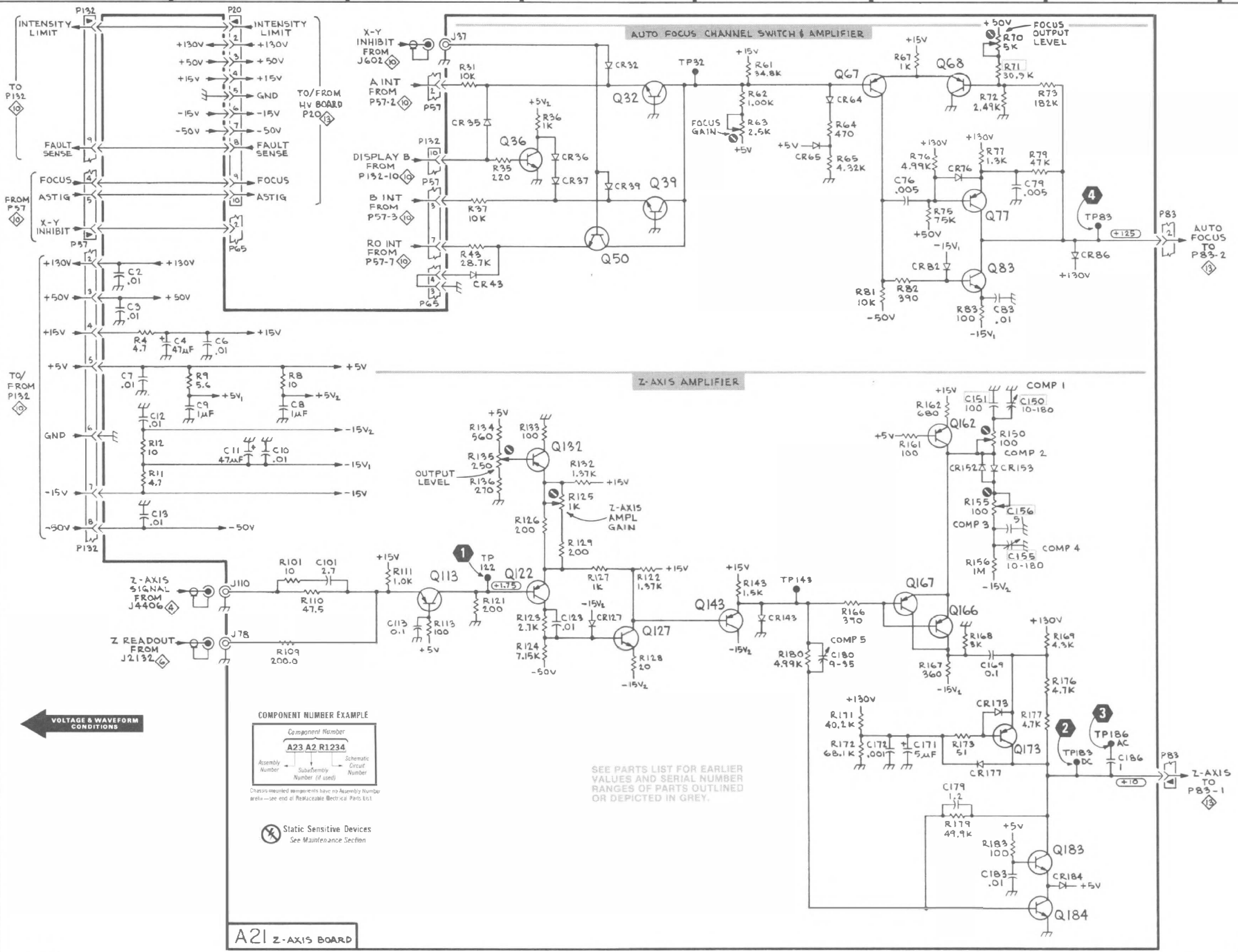

VOLTAGE & WAVEFORM CONDITIONS

COMPONENT NUMBER EXAMPLE

| | | | |
|------------------|------------------------------|--------------------------|--|
| Component Number | | | |
| A23 | A2 | R1234 | |
| Assembly Number | SubAssembly Number (if used) | Schematic Circuit Number | |

Chassis mounted components have no Assembly Number prefix—see end of Replaceable Electrical Parts List.

⊗ Static Sensitive Devices
See Maintenance Section

A21 Z-AXIS BOARD

SEE PARTS LIST FOR EARLIER VALUES AND SERIAL NUMBER RANGES OF PARTS OUTLINED OR DEPICTED IN GREY.

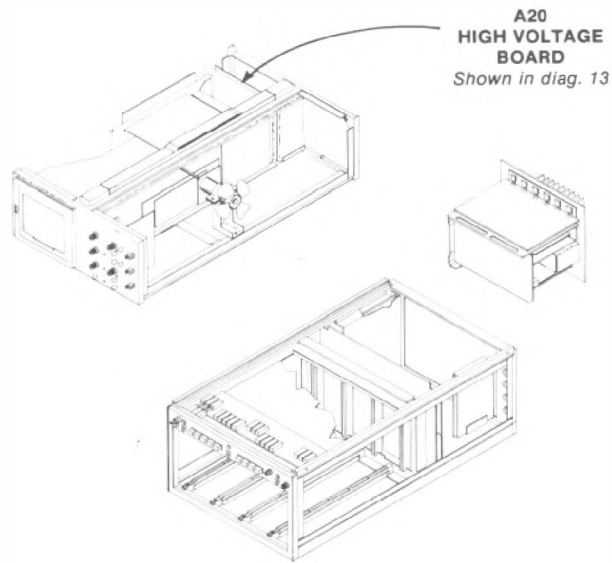
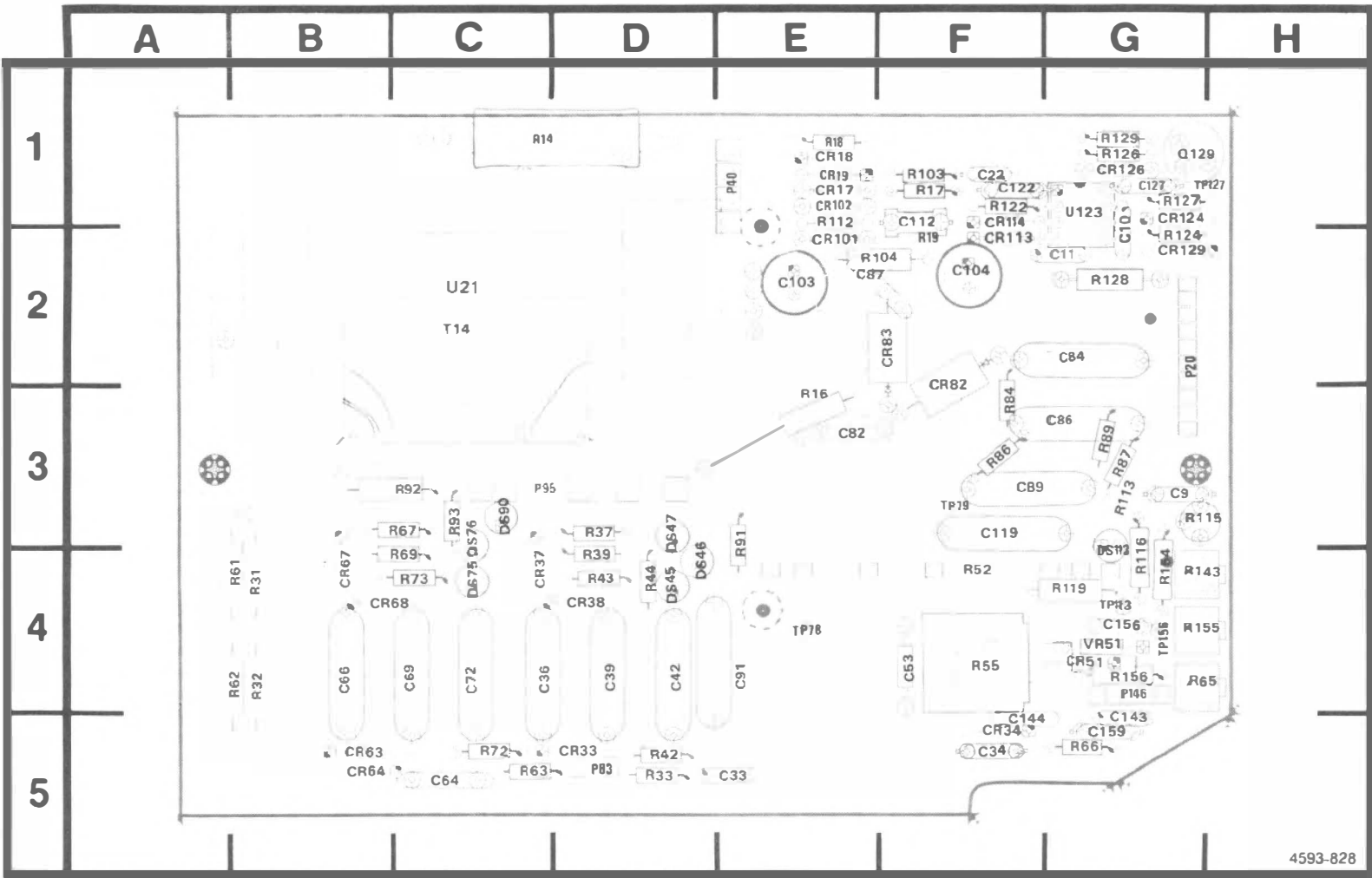

Static Sensitive Devices
See Maintenance Section

COMPONENT NUMBER EXAMPLE

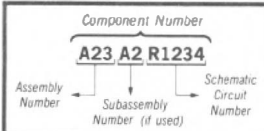

Chassis-mounted components have no Assembly Number prefix—see end of Replaceable Electrical Parts List

Figure 8-17A. A20—High Voltage circuit board assembly (SN B021130 & above).

REV JUL 1985

**HIGH-VOLTAGE POWER SUPPLY AND CRT DIAGRAM
(SN B021130 & ABOVE)**

13

ASSEMBLY A20

| CIRCUIT NUMBER | SCHEM LOCATION | BOARD LOCATION | CIRCUIT NUMBER | SCHEM LOCATION | BOARD LOCATION | CIRCUIT NUMBER | SCHEM LOCATION | BOARD LOCATION | CIRCUIT NUMBER | SCHEM LOCATION | BOARD LOCATION | CIRCUIT NUMBER | SCHEM LOCATION | BOARD LOCATION | CIRCUIT NUMBER | SCHEM LOCATION | BOARD LOCATION |
|----------------|----------------|----------------|----------------|----------------|----------------|----------------|----------------|----------------|----------------|----------------|----------------|----------------|----------------|----------------|----------------|----------------|----------------|
| C9 | A1 | G3 | C104 | B4 | F2 | CR68 | C3 | B4 | P20 | D2 | G2 | R43 | C2 | D4 | R92 | D4 | C3 |
| C10 | A1 | G2 | C112 | B5 | F1 | CR82 | C3 | F2 | P20 | F3 | G2 | R44 | C2 | D4 | R93 | D3 | C3 |
| C11 | A2 | G2 | C119 | C5 | F3 | CR83 | C3 | F2 | P40 | A4 | E1 | R52A | C5 | F4 | R103 | B4 | F1 |
| C22 | B1 | F1 | C122 | C5 | F1 | CR101 | B4 | E2 | P83 | A2 | D5 | R52B | D2 | F4 | R104 | B4 | E2 |
| C33 | B2 | E5 | C127 | C5 | G1 | CR102 | B4 | E1 | P95 | D2 | C3 | R52C | D2 | F4 | R112 | B5 | E1 |
| C34 | B2 | F5 | C143 | F2 | G5 | CR113 | B5 | F2 | P146 | F2 | G4 | R52D | D3 | F4 | R113 | B5 | G3 |
| C36 | C2 | C4 | C144 | F2 | F5 | CR114 | B5 | F1 | P146 | F2 | G4 | R55 | D2 | F4 | R115 | B5 | G3 |
| C39 | C2 | D4 | C156 | F2 | G4 | CR124 | C5 | G1 | Q129 | C5 | G1 | R61 | B3 | B4 | R116 | B5 | G4 |
| C42 | C2 | D4 | C159 | F3 | G5 | CR126 | C5 | G1 | R14 | A4 | C1 | R62 | B3 | B4 | R119 | C5 | G4 |
| C53 | D2 | F4 | | | | CR129 | C5 | G2 | R16 | B3 | E3 | R63 | B3 | C5 | R122 | C5 | F1 |
| C84 | B3 | C5 | CR17 | B4 | E1 | | | | R17 | B4 | F1 | R65 | B3 | H4 | R124 | C5 | G2 |
| C66 | C3 | B4 | CR18 | B4 | E1 | DS45 | C2 | D4 | R18 | B4 | E1 | R66 | B3 | G5 | R126 | C5 | G1 |
| C69 | C3 | C4 | CR19 | B4 | E1 | DS46 | C2 | D4 | R19 | B4 | F1 | R67 | C3 | C3 | R127 | C4 | G1 |
| C72 | C3 | C4 | CR33 | B2 | D5 | DS47 | C2 | D3 | R18 | B4 | E1 | R69 | C3 | C4 | R128 | C4 | G2 |
| C82 | C3 | E3 | CR34 | B2 | F5 | DS75 | C3 | C4 | R19 | B4 | F2 | R72 | C3 | C5 | R129 | C5 | G1 |
| C84 | C3 | G2 | CR37 | C2 | C4 | DS76 | C3 | C3 | R31 | B2 | B4 | R73 | C3 | C4 | R143 | F2 | G4 |
| C86 | C3 | G3 | CR38 | C2 | D4 | DS90 | D3 | C3 | R32 | B2 | B4 | R84 | C3 | F3 | R154 | F2 | G4 |
| C87 | C4 | E2 | CR51 | D2 | G4 | DS113 | B5 | G4 | R33 | B2 | D5 | R86 | C3 | F3 | R155 | F2 | G4 |
| C89 | C3 | F3 | CR63 | B3 | B5 | | | | R37 | C2 | D3 | R87 | C4 | G3 | R156 | F3 | G4 |
| C91 | D3 | E4 | CR64 | B3 | B5 | | | | R39 | C2 | D4 | R89 | C4 | G3 | | | |
| C103 | B4 | E2 | CR67 | C3 | B4 | | | | R42 | C2 | D5 | R91 | D3 | E3 | T14 | B3 | C2 |

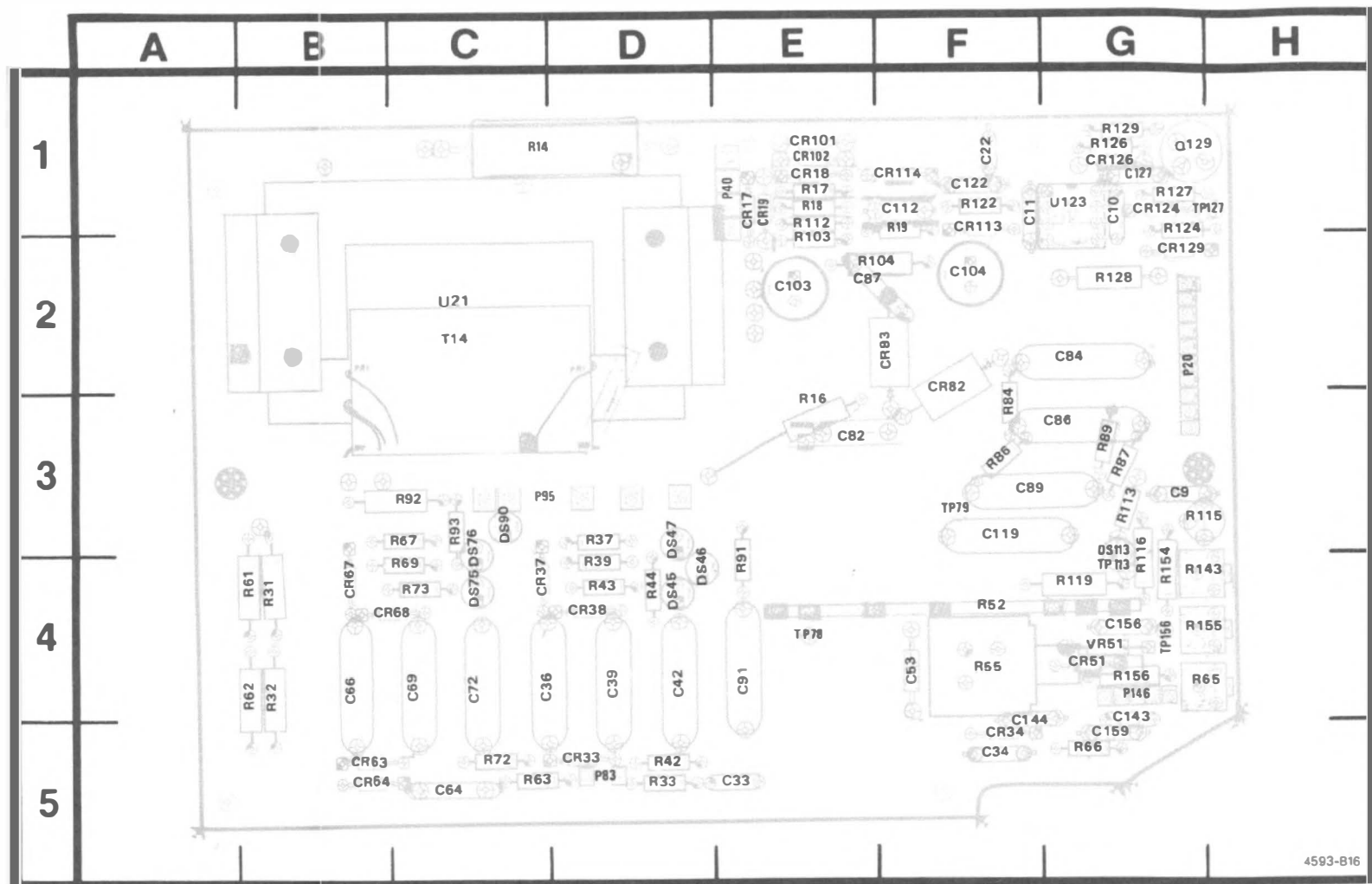

Figure 8-17B. A20—High Voltage circuit board assembly (SN B021129 & below).

**HIGH-VOLTAGE POWER SUPPLY AND CRT DIAGRAM
(SN B021129 & BELOW)**

13

ASSEMBLY A20

| CIRCUIT NUMBER | SCHEM LOCATION | BOARD LOCATION | CIRCUIT NUMBER | SCHEM LOCATION | BOARD LOCATION | CIRCUIT NUMBER | SCHEM LOCATION | BOARD LOCATION | CIRCUIT NUMBER | SCHEM LOCATION | BOARD LOCATION | CIRCUIT NUMBER | SCHEM LOCATION | BOARD LOCATION | CIRCUIT NUMBER | SCHEM LOCATION | BOARD LOCATION |
|----------------|----------------|----------------|----------------|----------------|----------------|----------------|----------------|----------------|----------------|----------------|----------------|----------------|----------------|----------------|----------------|----------------|----------------|
| C9 | A1 | G3 | C104 | B4 | F2 | CR68 | C3 | B4 | P20 | D2 | G2 | R43 | C2 | D4 | R92 | D4 | C3 |
| C10 | A1 | G1 | C112 | B5 | F1 | CR82 | C3 | F2 | P20 | F3 | G2 | R44 | C2 | D4 | R93 | D3 | C3 |
| C11 | A2 | F1 | C119 | C5 | F3 | CR83 | C3 | F2 | P40 | A4 | E1 | R52A | C5 | F4 | R103 | B4 | E2 |
| C22 | B1 | F1 | C122 | C5 | F1 | CR101 | B4 | E1 | P83 | A2 | D5 | R52B | D2 | F4 | R104 | B4 | E2 |
| C33 | B2 | F5 | C127 | C5 | G1 | CR102 | B4 | E1 | P95 | D2 | C3 | R52C | D2 | F4 | R112 | B5 | E1 |
| C34 | B2 | F5 | C143 | F2 | G4 | CR113 | B5 | F1 | P146 | F2 | G4 | R52D | D3 | F4 | R113 | B5 | G3 |
| C36 | C2 | C4 | C144 | F2 | F4 | CR114 | B5 | F1 | P146 | F2 | G4 | R55 | D2 | F4 | R115 | B5 | G3 |
| C39 | C2 | D4 | C156 | F2 | G4 | CR124 | C5 | G1 | Q129 | C5 | G1 | R61 | B3 | B4 | R116 | B5 | G4 |
| C42 | C2 | D4 | C159 | F3 | G5 | CR126 | C5 | G1 | R14 | A4 | C1 | R62 | B3 | B4 | R119 | C5 | G4 |
| C53 | D2 | F4 | | | | CR129 | C5 | G2 | R16 | B3 | E3 | R63 | B3 | C5 | R122 | C5 | F1 |
| C64 | B3 | C5 | CR17 | B4 | E1 | | | | R17 | B4 | E1 | R65 | B3 | H4 | R124 | C5 | G1 |
| C66 | C3 | B4 | CR18 | B4 | E1 | DS45 | C2 | D4 | R18 | B4 | E1 | R66 | B3 | G5 | R126 | C5 | G1 |
| C69 | C3 | C4 | CR19 | B4 | E1 | DS46 | C2 | D4 | R19 | B4 | F1 | R67 | C3 | C3 | R127 | C4 | G1 |
| C72 | C3 | C4 | CR33 | B2 | D5 | DS47 | C2 | D3 | R18 | B4 | E1 | R69 | C3 | C4 | R128 | C4 | G2 |
| CR2 | C3 | E3 | CR34 | B2 | F5 | DS75 | C3 | C4 | R19 | B4 | F1 | R72 | C3 | C5 | R129 | C5 | G1 |
| CR4 | C3 | G2 | CR37 | C2 | C4 | DS76 | C3 | C3 | R31 | B2 | B4 | R73 | C3 | C4 | R143 | F2 | G4 |
| CR6 | C3 | G3 | CR38 | C2 | D4 | DS90 | D3 | C3 | R32 | B2 | B4 | R74 | C3 | F3 | R154 | F2 | G4 |
| CR7 | C4 | E2 | CR51 | D2 | G4 | DS113 | B5 | G3 | R33 | B2 | D5 | R76 | C3 | F3 | R155 | F2 | H4 |
| CR8 | C3 | F3 | CR63 | B3 | B5 | | | | R37 | C2 | D3 | R77 | C4 | G3 | R156 | F3 | G4 |
| CR9 | C3 | F3 | CR64 | B3 | B5 | P20 | A1 | G2 | R39 | C2 | D4 | R89 | C4 | G3 | | | |
| CR10 | D3 | E4 | CR67 | C3 | B4 | P20 | C1 | G2 | R42 | C2 | D5 | R91 | D3 | E4 | T14 | B3 | C2 |
| CR11 | B4 | E2 | | | | | | | | | | | | | | | |

VOLTAGE CONDITIONS

The voltage shown was obtained with the 7904A front panel variable controls at midrange except INTENSITY, OFF; VERTICAL MODE, RIGHT; TRIGGER SOURCE, VERT MODE; HORIZONTAL MODE, A. No plug-in units were installed.

Voltage Conditions. The voltage shown on the diagram was obtained using a digital multimeter with a 100 M Ω input impedance (Valhalla 4500 High Voltage Digital Multimeter).

A

B

C

D

E

F

G

1

2

3

4

5

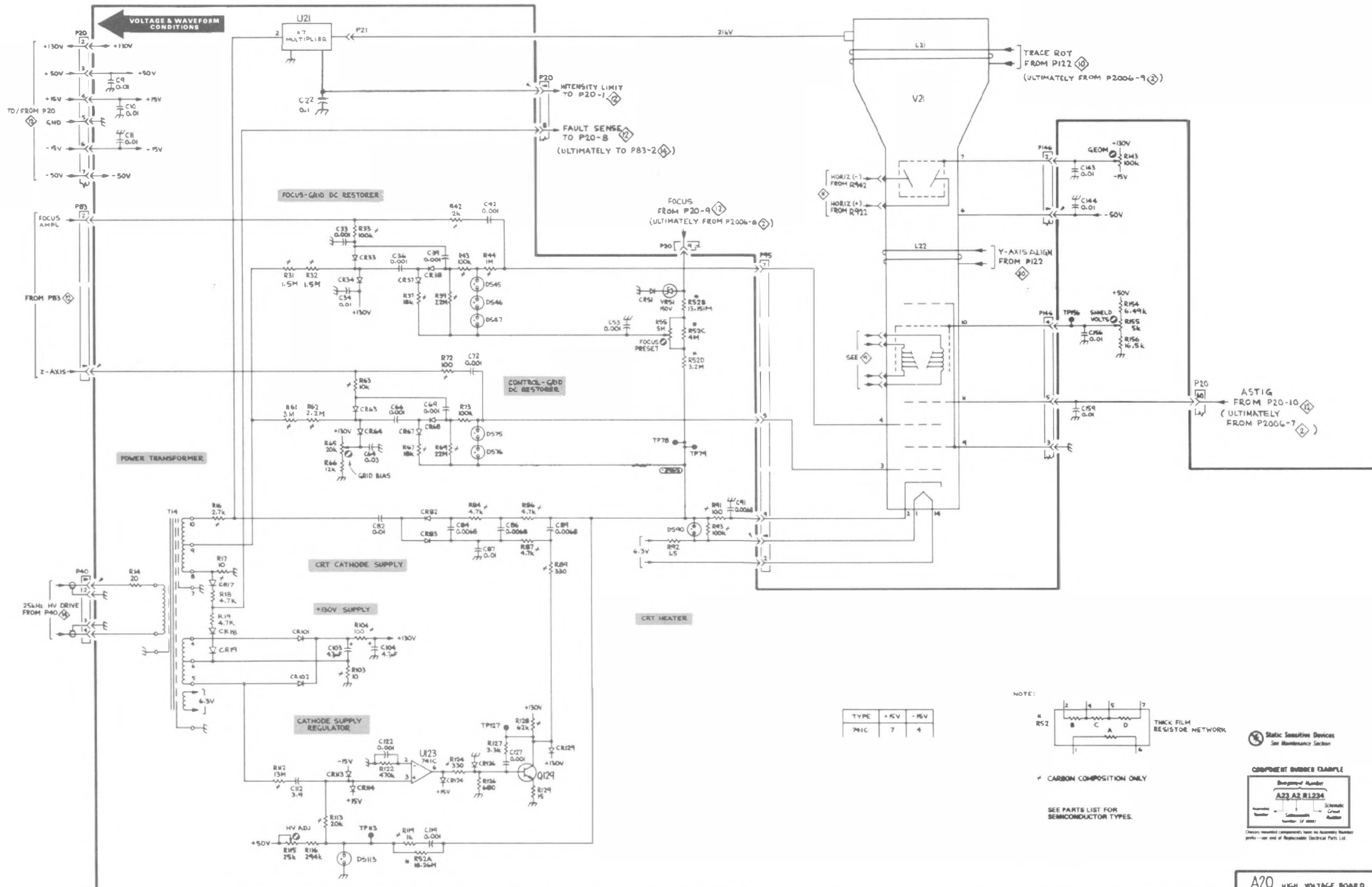

| TYPE | +5V | -15V |
|------|-----|------|
| 781C | 7 | 4 |

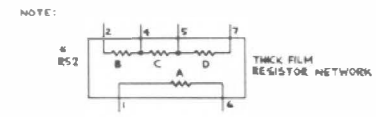

* CARBON COMPOSITION ONLY

SEE PARTS LIST FOR SEMICONDUCTOR TYPES.

Static Sensitive Devices See Maintenance Section

COMPONENT NUMBER EXAMPLE

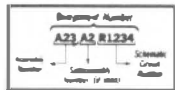

Check mounted components for the Assembly Number prefix - see end of Resistor Electrical Parts List.

A20 HIGH VOLTAGE BOARD



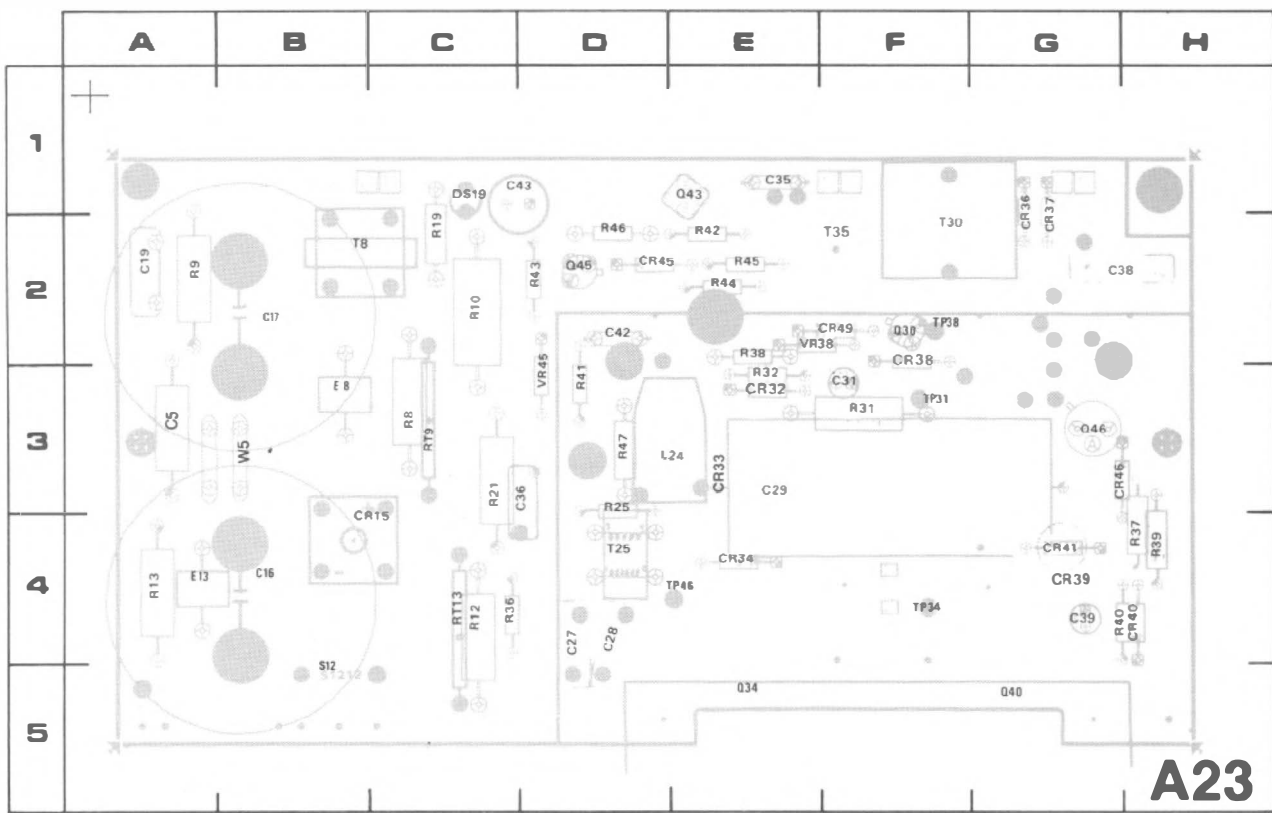

Figure 8-18. A23—Inverter circuit board assembly.

A23

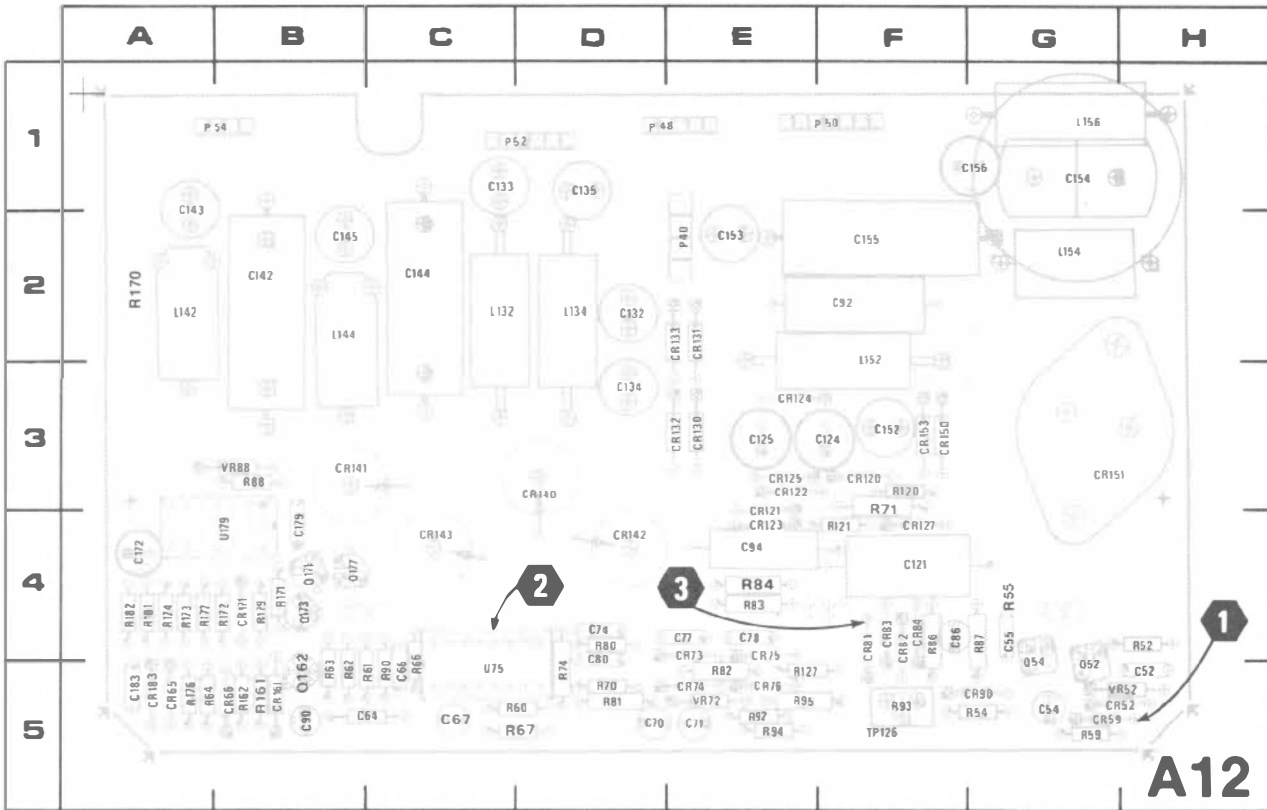

Figure 8-19. A12—Control Rectifier circuit board assembly.

CONVERTER/RECTIFIER DIAGRAM 14

ASSEMBLY A12

| CIRCUIT NUMBER | SCHEM LOCATION | BOARD LOCATION | CIRCUIT NUMBER | SCHEM LOCATION | BOARD LOCATION | CIRCUIT NUMBER | SCHEM LOCATION | BOARD LOCATION | CIRCUIT NUMBER | SCHEM LOCATION | BOARD LOCATION | CIRCUIT NUMBER | SCHEM LOCATION | BOARD LOCATION | CIRCUIT NUMBER | SCHEM LOCATION | BOARD LOCATION |
|----------------|----------------|----------------|----------------|----------------|----------------|----------------|----------------|----------------|----------------|----------------|----------------|----------------|----------------|----------------|----------------|----------------|----------------|
| C52 | B3 | H5 | C144 | E2 | C2 | CR121 | E1 | E4 | L152 | E3 | F2 | R63 | B4 | B5 | R170 | D5 | A2 |
| C54 | B3 | G5 | C145 | F2 | B2 | CR122 | E2 | E3 | L154 | E3 | G2 | R64 | B4 | A5 | R171 | E4 | B4 |
| C55 | B3 | G4 | C152 | E3 | F3 | CR123 | E2 | E4 | L156 | E3 | G1 | R66 | B4 | C5 | R172 | E4 | B4 |
| C64 | B3 | C5 | C153 | F3 | E2 | CR124 | E1 | E3 | | | | R67 | B4 | C5 | R173 | E3 | A4 |
| C66 | B4 | C5 | C154 | E3 | G1 | CR125 | E2 | E3 | P4D | E1 | E2 | R70 | C3 | D5 | R174 | E4 | A4 |
| C67 | B4 | C5 | C155 | F3 | F2 | CR127 | E1 | F4 | P48 | F2 | D1 | R71 | C3 | F4 | R176 | E4 | A5 |
| C70 | C3 | D5 | C156 | F3 | F1 | CR130 | E2 | E3 | P5D | F3 | F1 | R74 | C4 | D5 | R177 | E4 | A4 |
| C71 | C3 | E5 | C172 | E4 | A4 | CR131 | E2 | E2 | P52 | F2 | C1 | R80 | C4 | D4 | R179 | E3 | B4 |
| C74 | C4 | D4 | C179 | F3 | B4 | CR132 | E2 | E3 | P54 | D5 | A1 | R81 | C4 | D5 | R181 | E3 | A4 |
| C77 | D3 | E4 | C183 | F3 | A5 | CR133 | E2 | E2 | P54. | F4 | A1 | R82 | C4 | E5 | R182 | E3 | A4 |
| C78 | D3 | E4 | | | | CR140 | E2 | D3 | | | | R83 | C4 | E4 | | | |
| C80 | C4 | D5 | CR52 | B3 | G5 | CR141 | E2 | B3 | Q52 | B3 | G5 | R84 | C4 | F4 | TP126 | F1 | F5 |
| CB6 | D4 | F4 | CR59 | B3 | G5 | CR142 | E2 | D4 | O54 | B3 | G5 | R86 | D4 | F4 | | | |
| C90 | D4 | B5 | CR65 | B4 | A5 | CR143 | E2 | C4 | Q162 | D4 | B5 | R87 | D4 | G4 | U75 | C4 | C5 |
| C92 | D4 | F2 | CR66 | B4 | B5 | CR150 | E3 | F3 | Q171 | E4 | B4 | R88 | D5 | B3 | U179A | E4 | B4 |
| C94 | D4 | E4 | CR73 | D3 | E5 | CR151 | E3 | G3 | Q173 | E4 | B4 | R90 | D4 | C5 | U179B | F4 | B4 |
| C121 | E2 | F4 | CR74 | D3 | E5 | CR153 | E3 | F3 | Q177 | E4 | B4 | R92 | D4 | E5 | U179C | E3 | B4 |
| C124 | E1 | F3 | CR75 | D3 | E5 | CR161 | D4 | B5 | | | | R93 | D4 | F5 | | | |
| C125 | E2 | E3 | CR76 | D3 | E5 | CR171 | E4 | B4 | R52 | B3 | H4 | R94 | D4 | E5 | VR52 | B3 | G5 |
| C132 | E2 | D2 | CR81 | C4 | F4 | CR183 | F3 | A5 | R54 | B3 | G5 | R95 | D4 | E5 | VR72 | C3 | E5 |
| C133 | F2 | C1 | CR82 | C4 | F4 | | | | R55 | C3 | G4 | R120 | E2 | F3 | VR88 | D5 | B3 |
| C134 | E2 | D3 | CR83 | C4 | F4 | L132 | E2 | C2 | R59 | B3 | G5 | R121 | E2 | F4 | | | |
| C135 | F2 | D1 | CR84 | D4 | F4 | L134 | E2 | D2 | R60 | B3 | C5 | R127 | E1 | E5 | | | |
| C142 | E2 | B2 | CR90 | C4 | G5 | L142 | E2 | A2 | R61 | B3 | C5 | R161 | D3 | B5 | | | |
| C143 | F2 | A1 | CR120 | E1 | F3 | L144 | E3 | B2 | R62 | B3 | B5 | R162 | D3 | B5 | | | |

A12 CONTROL RECTIFIER BOARD
Shown in diag. 14

ASSEMBLY A22

| CIRCUIT NUMBER | SCHEM LOCATION | BOARD LOCATION | CIRCUIT NUMBER | SCHEM LOCATION | BOARD LOCATION | CIRCUIT NUMBER | SCHEM LOCATION | BOARD LOCATION | CIRCUIT NUMBER | SCHEM LOCATION | BOARD LOCATION | CIRCUIT NUMBER | SCHEM LOCATION | BOARD LOCATION | CIRCUIT NUMBER | SCHEM LOCATION | BOARD LOCATION |
|----------------|----------------|----------------|----------------|----------------|----------------|----------------|----------------|----------------|----------------|----------------|----------------|----------------|----------------|----------------|----------------|----------------|----------------|
| C8 | E5 | F5 | CR8 | E5 | F5 | P54 | F4 | F5 | P83 | F5 | E5 | R2 | E4 | E5 | R5 | E5 | E6 |
| CR7 | E5 | F5 | P54 | E5 | F5 | P72 | E4 | F5 | P82 | E4 | F6 | R3 | E4 | E5 | R8 | E5 | F5 |
| | | | | | | | | | | | | R4 | E4 | E5 | | | |

Partial A22 also shown on diagram 15.

ASSEMBLY A23

| CIRCUIT NUMBER | SCHEM LOCATION | BOARD LOCATION | CIRCUIT NUMBER | SCHEM LOCATION | BOARD LOCATION | CIRCUIT NUMBER | SCHEM LOCATION | BOARD LOCATION | CIRCUIT NUMBER | SCHEM LOCATION | BOARD LOCATION | CIRCUIT NUMBER | SCHEM LOCATION | BOARD LOCATION | CIRCUIT NUMBER | SCHEM LOCATION | BOARD LOCATION |
|----------------|----------------|----------------|----------------|----------------|----------------|----------------|----------------|----------------|----------------|----------------|----------------|----------------|----------------|----------------|----------------|----------------|----------------|
| C5 | A2 | A3 | CR15 | B1 | C4 | E8 | B1 | B3 | R10 | B2 | C2 | R43 | D2 | D2 | TP31* | C1 | F3 |
| C6* | A2 | B3 | CR32 | C1 | D3 | E13 | A1 | A4 | R12* | A1 | C4 | R44 | D1 | E2 | TP34 | D1 | F4 |
| C16 | B1 | B4 | CR33 | C1 | E3 | | | | R13 | A1 | A4 | R45 | D1 | E2 | TP38* | C2 | F2 |
| C17 | B1 | B2 | CR34 | C1 | E4 | L24 | C1 | E3 | R19 | B1 | C2 | R46 | D2 | D2 | TP46 | B2 | E4 |
| C19 | B1 | A2 | CR36 | B2 | G1 | | | | R21 | B1 | C3 | R47 | D1 | D3 | | | |
| C27 | C1 | D4 | CR37 | B2 | G1 | Q30 | C2 | F2 | R25 | B1 | D3 | | | | VR3B | C2 | F1 |
| C28 | C1 | D4 | CR38 | D1 | F3 | Q34 | C1 | E5 | R31 | C1 | F3 | RT9 | B2 | C3 | VR45 | C2 | D3 |
| C29 | C1 | E3 | CR39 | C1 | G4 | Q40 | C2 | G5 | R32 | C1 | E3 | RT13 | A1 | C4 | | | |
| C31 | C1 | F3 | CR40 | C2 | H4 | Q43 | D2 | E1 | R36 | D2 | C4 | | | | W5* | A2 | A3 |
| C35 | D2 | E1 | CR41 | C2 | G4 | Q45 | D1 | D2 | R37 | C2 | H4 | S12 | A1 | B5 | | | |
| C36 | D2 | D3 | CR45 | D1 | D2 | Q46 | C2 | G3 | R38 | C2 | E2 | | | | | | |
| C38 | C2 | H2 | CR46 | C2 | G3 | | | | R39 | C2 | H4 | T8 | A2 | B2 | | | |
| C39 | C2 | G4 | CR49 | C2 | F1 | R5* | A2 | A3 | R4D | C2 | G4 | T25 | B1 | D4 | | | |
| C42 | C2 | D2 | | | | R8* | B2 | C3 | R41 | C2 | D3 | T30 | C1 | F1 | | | |
| C43 | D2 | D1 | DS19 | B1 | C1 | R9 | A2 | A2 | R42 | D2 | E2 | T35 | D2 | E2 | | | |

CHASSIS MOUNTED PARTS

| CIRCUIT NUMBER | SCHEM LOCATION | BOARD LOCATION | CIRCUIT NUMBER | SCHEM LOCATION | BOARD LOCATION | CIRCUIT NUMBER | SCHEM LOCATION | BOARD LOCATION | CIRCUIT NUMBER | SCHEM LOCATION | BOARD LOCATION |
|----------------|----------------|----------------|----------------|----------------|----------------|----------------|----------------|----------------|----------------|----------------|----------------|
| C37 | D1 | CHASSIS | FL10 | A3 | CHASSIS | P10 | A4 | CHASSIS | S10 | A3 | CHASSIS |
| F10 | A3 | CHASSIS | L37 | D1 | CHASSIS | P11 | A3 | CHASSIS | T11D | D2 | CHASSIS |

*See Parts List for serial number ranges.

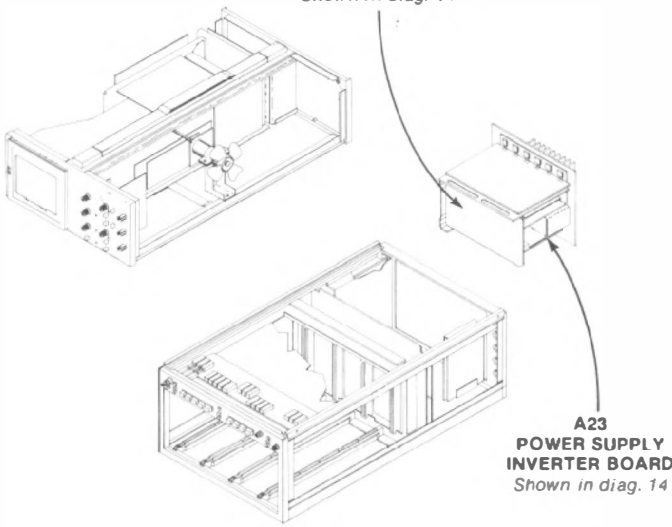

VOLTAGE AND WAVEFORM CONDITIONS

The voltages and waveforms shown were obtained with the 7904A front panel variable controls at midrange except INTENSITY control is set fully counterclockwise; VERTICAL MODE, LEFT; TRIGGER SOURCE, VERT MODE; HORIZONTAL MODE, B. No plug-in units were installed.

Voltage Conditions. The voltages shown on the diagram were obtained using a digital multimeter with a $10\text{ M}\Omega$ input impedance (TEKTRONIX DM 501A Digital Multimeter).

Waveform Conditions. The waveforms shown below were obtained using a test oscilloscope system with $10\text{ M}\Omega$ input impedance and at least 60 MHz bandwidth. (TEKTRONIX 7603 Oscilloscope, 7B53A Time Base, and 7A13 Differential Comparator equipped with a $10\times$ probe.)

Voltage shown near the waveforms are display center dc levels.

1

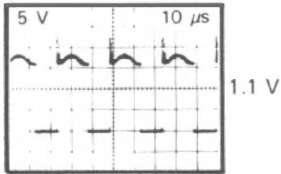

2

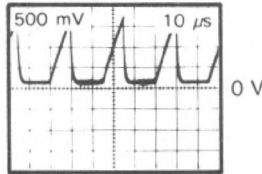

3

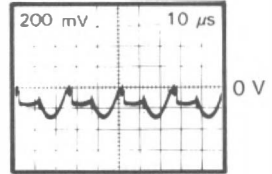

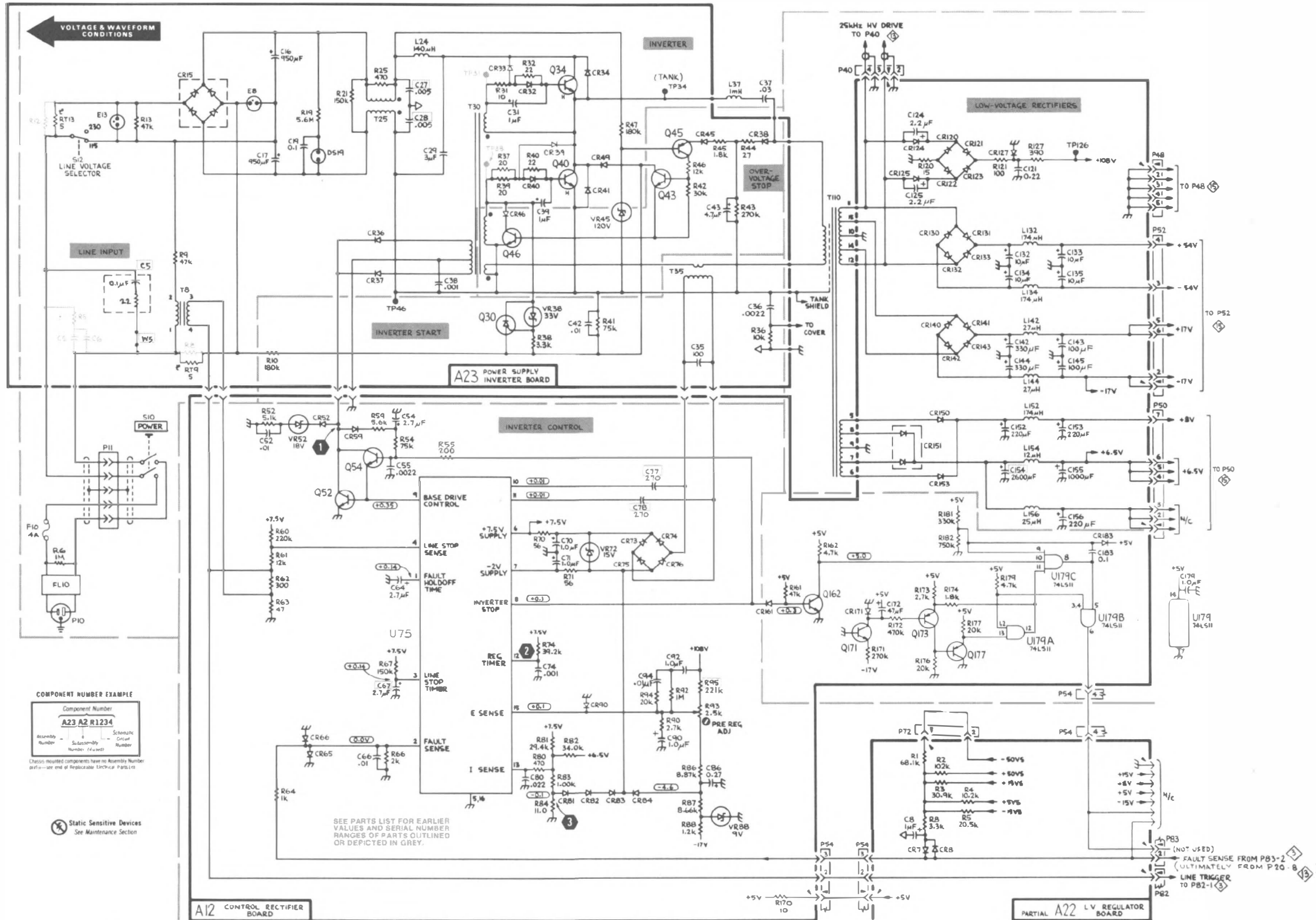

1

2

3

4

5

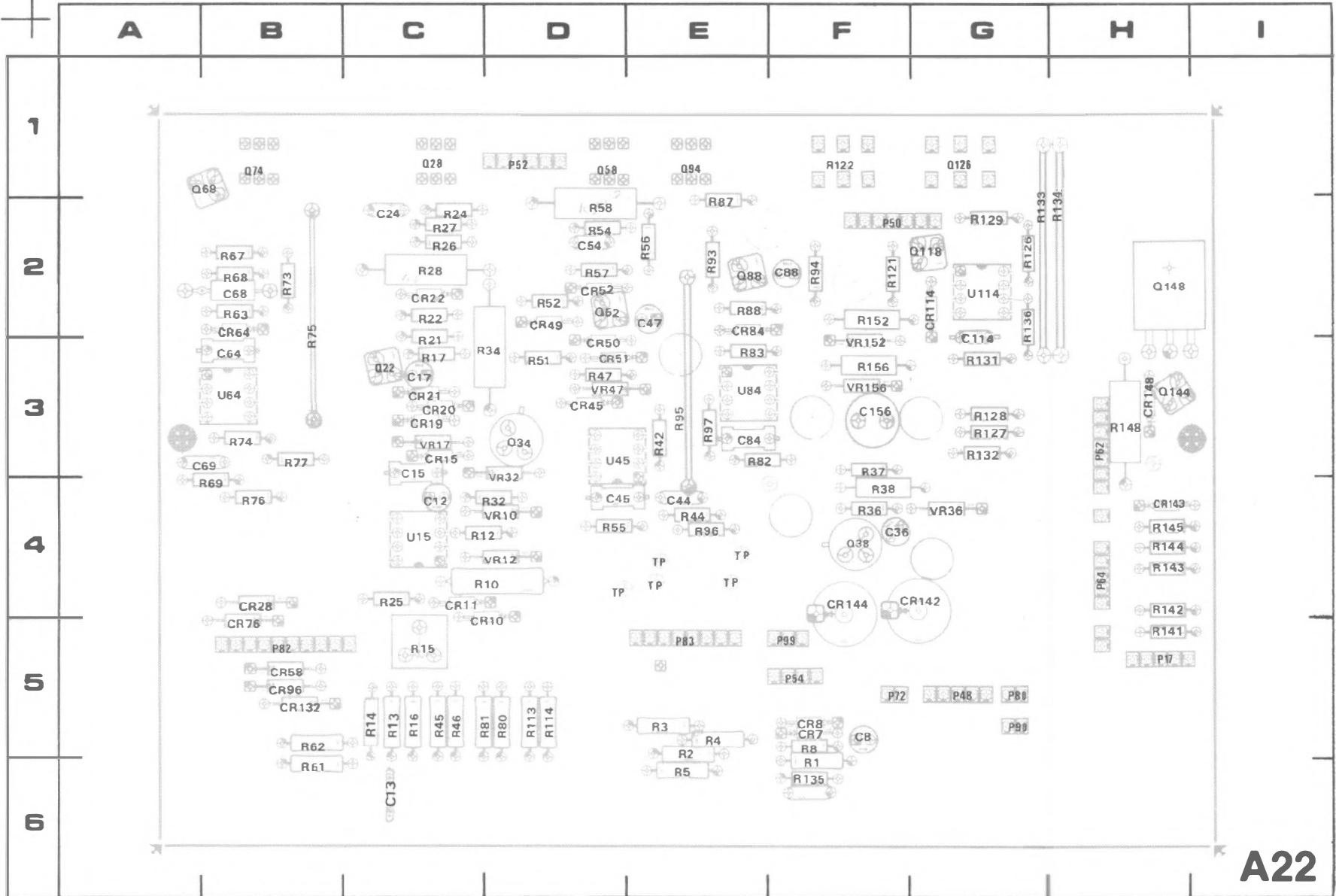

A22

4593-819

Figure 8-20. A22—Low Voltage Regulator circuit board assembly.

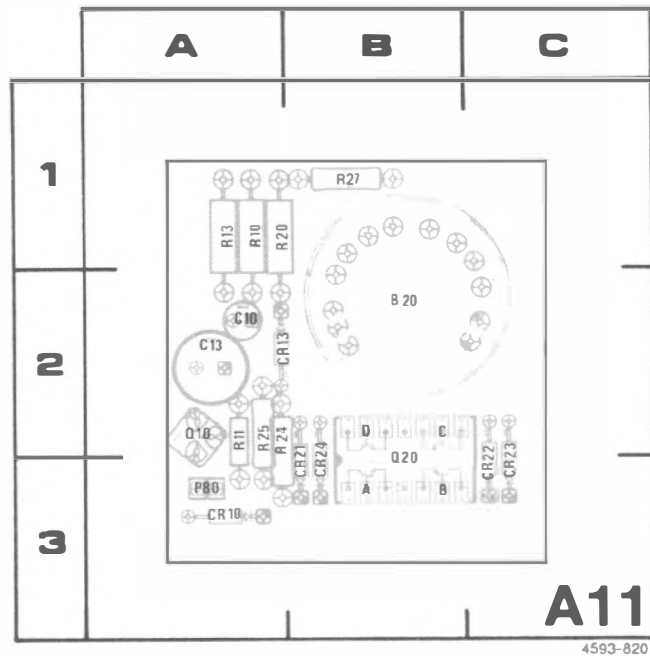
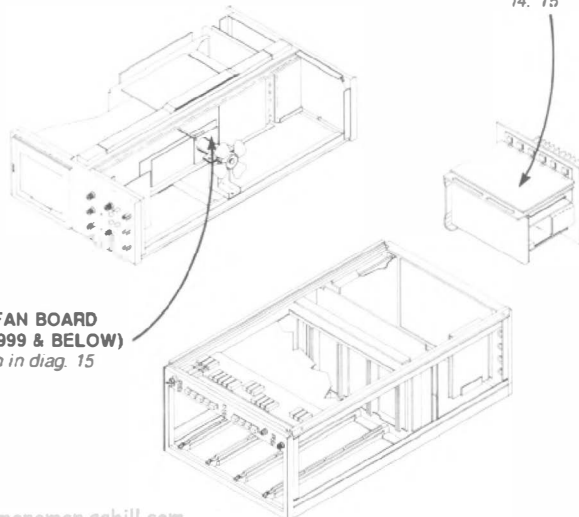

Figure 8-21. A11—Fan circuit board assembly (SN B039999 & Below).

A22
LOW VOLTAGE
REGULATOR BOARD
Shown in diag.
14, 15



A11—FAN BOARD
(SN B039999 & BELOW)
Shown in diag. 15

LOW-VOLTAGE REGULATORS AND FAN DIAGRAM 15

ASSEMBLY A11 (SN B039999 & BELOW)

| CIRCUIT NUMBER | SCHEM LOCATION | BOARD LOCATION | CIRCUIT NUMBER | SCHEM LOCATION | BOARD LOCATION | CIRCUIT NUMBER | SCHEM LOCATION | BOARD LOCATION | CIRCUIT NUMBER | SCHEM LOCATION | BOARD LOCATION | CIRCUIT NUMBER | SCHEM LOCATION | BOARD LOCATION |
|----------------|----------------|----------------|----------------|----------------|----------------|----------------|----------------|----------------|----------------|----------------|----------------|----------------|----------------|----------------|
| B20 | B4 | B2 | CR13 | C4 | A2 | P80 | A4 | A3 | Q20D | B5 | B3 | R24 | C5 | A2 |
| C10 | B4 | A2 | CR21 | C4 | B3 | Q10 | B4 | A2 | R10 | B4 | A1 | R25 | C5 | A2 |
| C13 | B4 | A2 | CR22 | C4 | C3 | Q20A | B5 | B3 | R11 | B4 | A2 | R27 | B4 | B1 |
| CR10 | A4 | A3 | CR23 | C4 | C3 | Q20B | A5 | B3 | R13 | B4 | A1 | | | |
| | | | CR24 | C5 | B3 | Q20C | B5 | B3 | R20 | B5 | A1 | | | |

ASSEMBLY A22

| CIRCUIT NUMBER | SCHEM LOCATION | BOARD LOCATION | CIRCUIT NUMBER | SCHEM LOCATION | BOARD LOCATION | CIRCUIT NUMBER | SCHEM LOCATION | BOARD LOCATION | CIRCUIT NUMBER | SCHEM LOCATION | BOARD LOCATION | CIRCUIT NUMBER | SCHEM LOCATION | BOARD LOCATION |
|----------------|----------------|----------------|----------------|----------------|----------------|----------------|----------------|----------------|----------------|----------------|----------------|----------------|----------------|----------------|
| C12 | B1 | C4 | CR84 | D2 | E2 | Q88 | D2 | E2 | R54 | B3 | D2 | R131 | D3 | G3 |
| C13 | B2 | C6 | CR96 | E2 | B5 | Q94 | E2 | E1 | R55 | C3 | D4 | R132 | E3 | G3 |
| C15 | B2 | C3 | CR114 | D3 | G2 | Q118 | D3 | G2 | R56 | C3 | E2 | R133 | E3 | G2 |
| C17 | B1 | C3 | CR132 | E3 | B5 | Q122 | E3 | F1 | R57 | C3 | D2 | R134 | E3 | H2 |
| C24 | B1 | C2 | CR142 | D4 | G4 | Q126 | E3 | G1 | R58 | B3 | D2 | R135 | E3 | F6 |
| C36 | B2 | F4 | CR143 | D4 | H4 | Q144 | D4 | G5 | R61 | D1 | B6 | R136 | E3 | G2 |
| C44 | B2 | E4 | CR143 | D4 | H4 | Q148 | E4 | G5 | R62 | D1 | B5 | R141 | D4 | H5 |
| C45 | B3 | D4 | CR144 | D4 | F4 | | | | R63 | D2 | B2 | R142 | D4 | H4 |
| C47 | B3 | E2 | CR148 | E4 | G5 | R10 | A1 | D4 | R67 | E1 | B2 | R143 | D4 | H4 |
| C54 | B3 | D2 | | | | R12 | B1 | C4 | R68 | E1 | B2 | R144 | D4 | H4 |
| C64 | D1 | B3 | P17 | D4 | H5 | R13 | B2 | C6 | R69 | E1 | B4 | R145 | E4 | H4 |
| C68 | E1 | B2 | P48 | C3 | G5 | R14 | B2 | C5 | R73 | E1 | B2 | R148 | E4 | G5 |
| C69 | E1 | B3 | P50 | D4 | F2 | R15 | B2 | C5 | R74 | E2 | B3 | R152 | D2 | F2 |
| C84 | D2 | E3 | P52 | A1 | D1 | R16 | B2 | C5 | R75 | E1 | B2 | R156 | D2 | F3 |
| C88 | E2 | F2 | P52 | D1 | D1 | R17 | B1 | C3 | R76 | E1 | B4 | | | |
| C114 | D3 | G2 | P62 | E4 | G5 | R21 | B1 | C3 | R77 | E1 | B3 | U15 | B1 | C4 |
| C156 | D2 | F3 | P82 | C1 | B5 | R22 | B1 | C2 | R80 | D3 | D5 | U45 | B3 | D3 |
| | | | P82 | C3 | B5 | R24 | B1 | C2 | R81 | D3 | C5 | U64A | D1 | B3 |
| CR10 | A1 | D5 | P82 | F1 | B5 | R25 | C2 | C4 | R82 | D2 | E3 | U64B | E2 | B3 |
| CR11 | A1 | C4 | P82 | F3 | B5 | R26 | C1 | C2 | R83 | D2 | E3 | U84A | E2 | E3 |
| CR15 | B1 | C3 | P83 | C2 | E5 | R27 | C1 | C2 | R87 | E2 | E2 | U84B | D2 | E3 |
| CR19 | B1 | C3 | P83 | F1 | E5 | R28 | C1 | C2 | R88 | D2 | E2 | U114A | D3 | G2 |
| CR20 | B1 | C3 | P83 | F3 | E5 | R32 | A2 | D4 | R93 | E2 | E2 | U114B | E3 | G2 |
| CR21 | B1 | C3 | P90 | A3 | G5 | R34 | B2 | D3 | R94 | E2 | F2 | | | |
| CR22 | B1 | C2 | P99 | D3 | F5 | R36 | B2 | F4 | R95 | E2 | F3 | VR10 | A1 | D4 |
| CR28 | C1 | B4 | Q22 | B1 | C3 | R37 | B2 | F3 | R96 | E2 | E4 | VR12 | A1 | D4 |
| CR45 | B3 | D3 | Q28 | C1 | C1 | R38 | B2 | F4 | R97 | E2 | E3 | VR17 | B1 | C3 |
| CR49 | B3 | D2 | Q34 | A2 | D3 | R42 | B3 | E3 | R113 | D3 | D5 | VR32 | A2 | D3 |
| CR50 | B3 | D3 | Q38 | B2 | F4 | R44 | R2 | E4 | R114 | D3 | D5 | VR36 | B2 | G4 |
| CR51 | B3 | D3 | Q52 | B3 | D2 | R45 | B2 | C5 | R121 | E3 | F2 | VR47 | B3 | D3 |
| CR52 | B3 | D2 | Q58 | B3 | D1 | R46 | B3 | C5 | R122 | E3 | F1 | VR152 | D2 | F3 |
| CR58 | C3 | B5 | Q68 | D1 | B1 | R47 | B3 | D3 | R126 | E3 | G2 | VR156 | D2 | F3 |
| CR64 | D1 | B2 | Q74 | E1 | B1 | R51 | B3 | D3 | R127 | E3 | G3 | | | |
| CR76 | E1 | B5 | | | | R52 | B3 | D2 | R128 | E3 | G3 | | | |
| | | | | | | | | | R129 | E3 | G2 | | | |

Partial A22 also shown on diagram 14.

CHASSIS MOUNTED PARTS

| CIRCUIT NUMBER | SCHEM LOCATION | BOARD LOCATION | | | |
|----------------|----------------|----------------|--|--|--|
| S99 | C3 | CHASSIS | | | |

REV FEB 1986

A**B****C****D****E****F**

VOLTAGE & WAVEFORM CONDITIONS

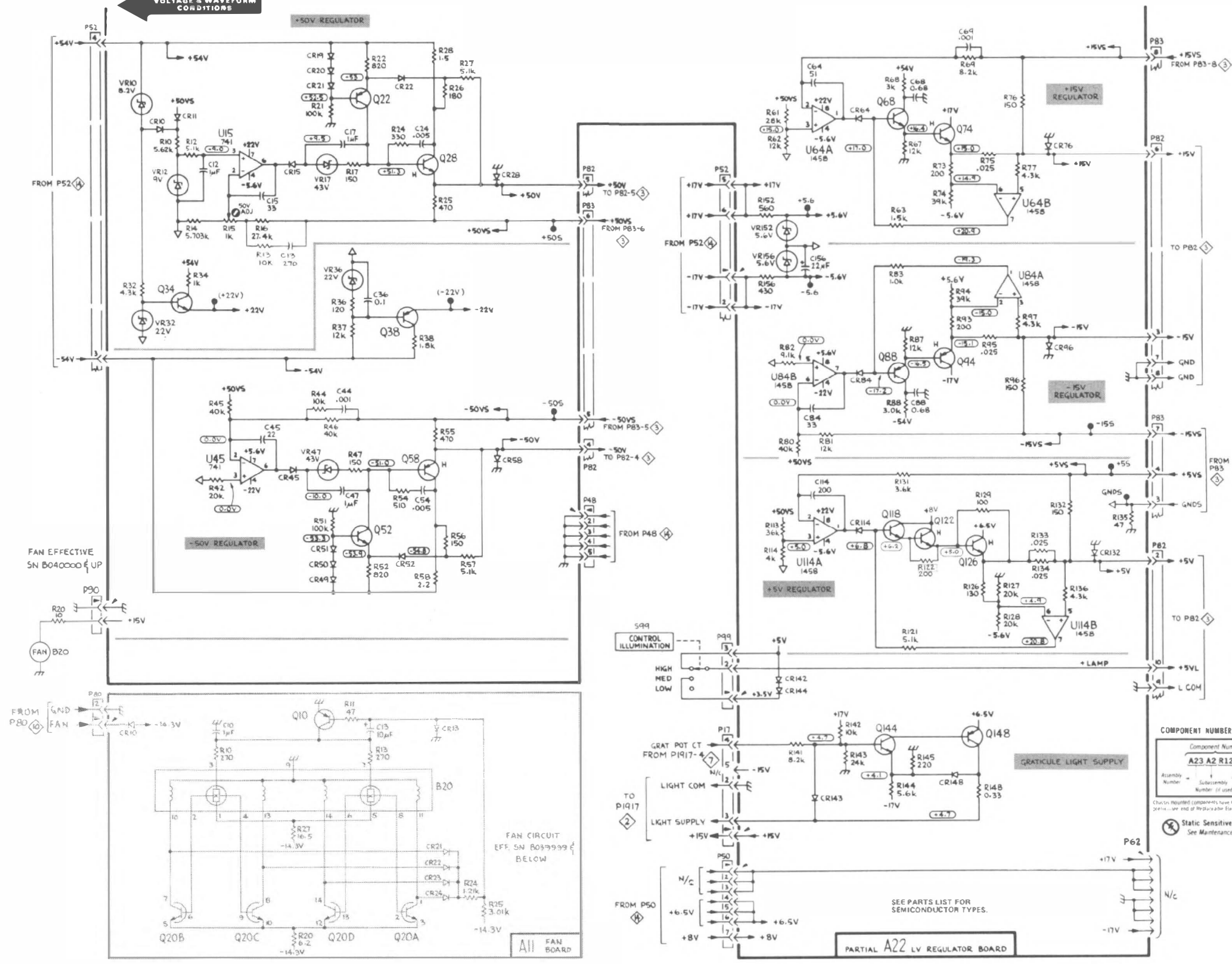

FAN EFFECTIVE
SN B040000 UP

FAN CIRCUIT
EFF. SN B039999
BELOW

ALL FAN BOARD

COMPONENT NUMBER EXAMPLE

| | | |
|------------------|------------------------------|--------------------------|
| Component Number | | |
| A23 | A2 | R1234 |
| Assembly Number | Subassembly Number (if used) | Schematic Circuit Number |

Check mounted components have no Assembly Number prefix - see end of Manufacturer's Electrical Part List

Static Sensitive Devices
See Maintenance Section

SEE PARTS LIST FOR SEMICONDUCTOR TYPES.

PARTIAL A22 LV REGULATOR BOARD

LOW-VOLTAGE REGULATORS AND FAN

7904A

4593-844
REV FEB 1986

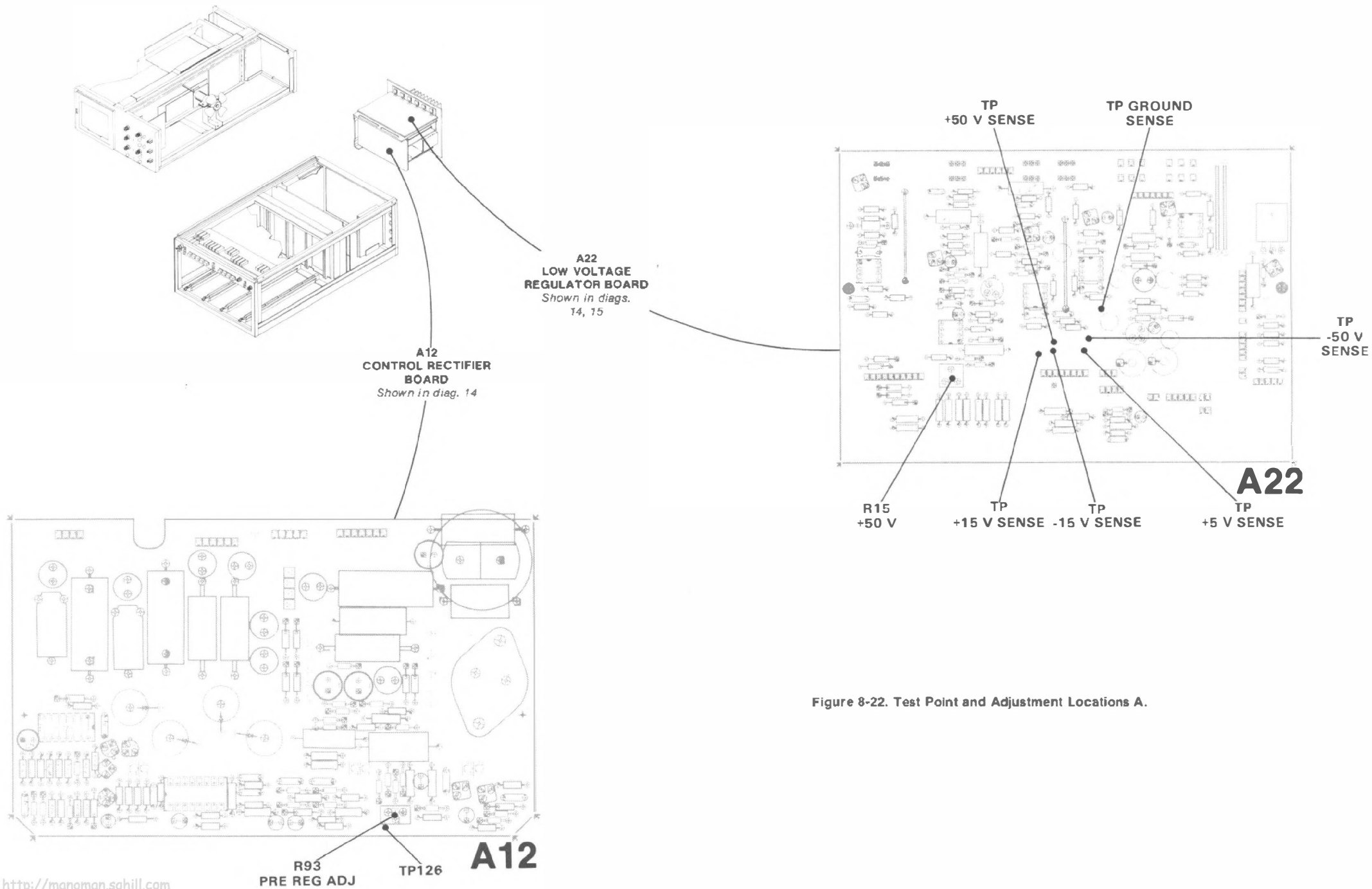

Figure 8-22. Test Point and Adjustment Locations A.

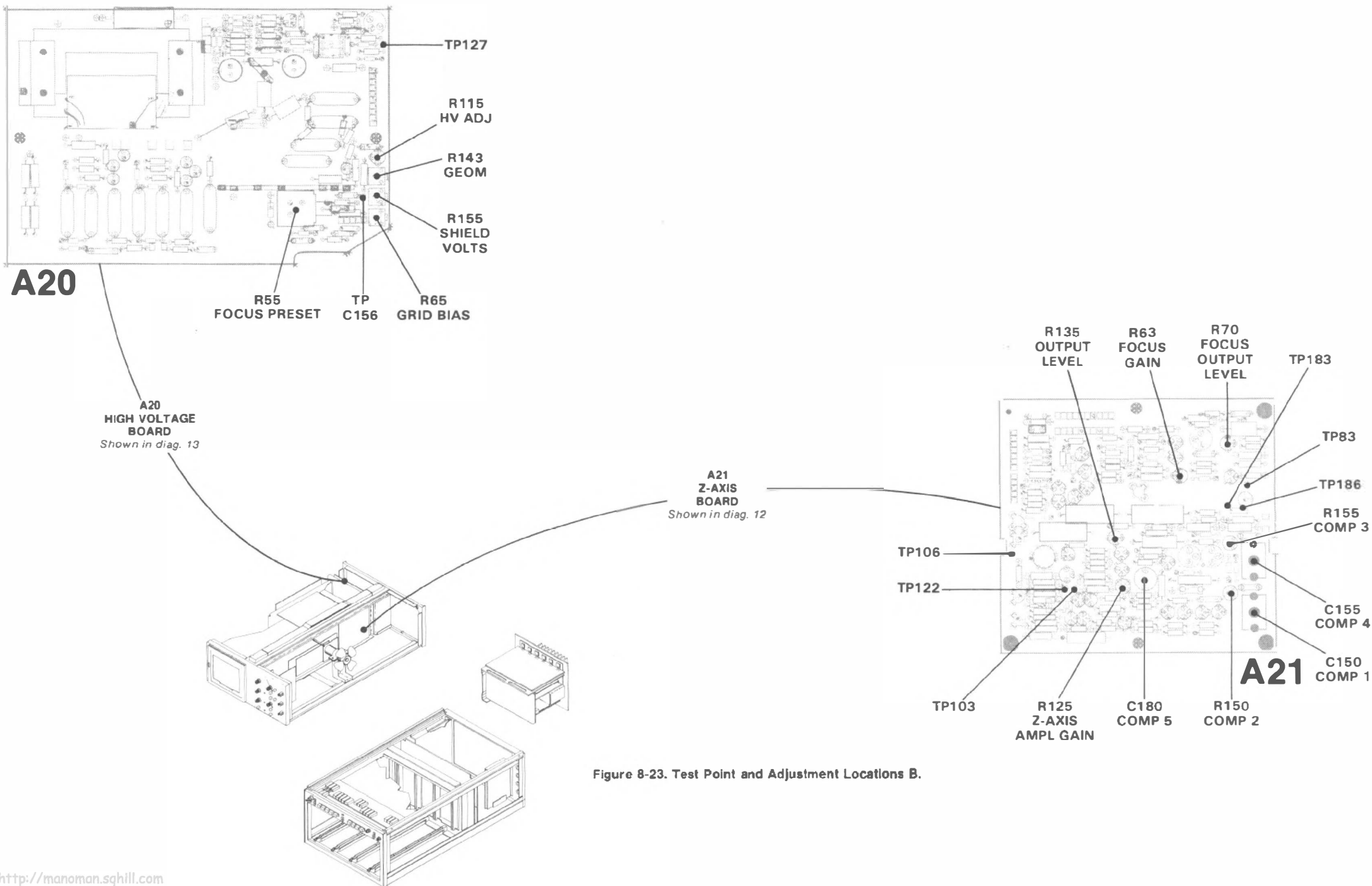

Figure 8-23. Test Point and Adjustment Locations B.

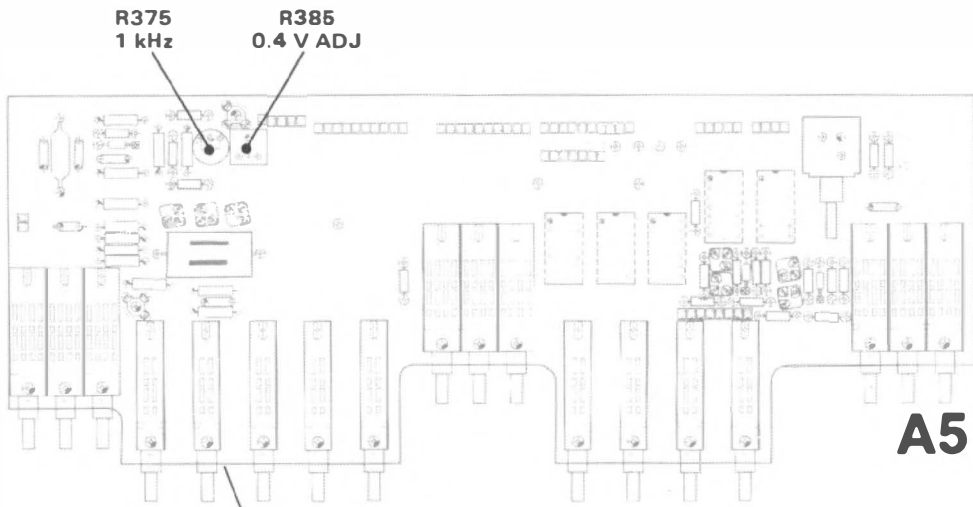
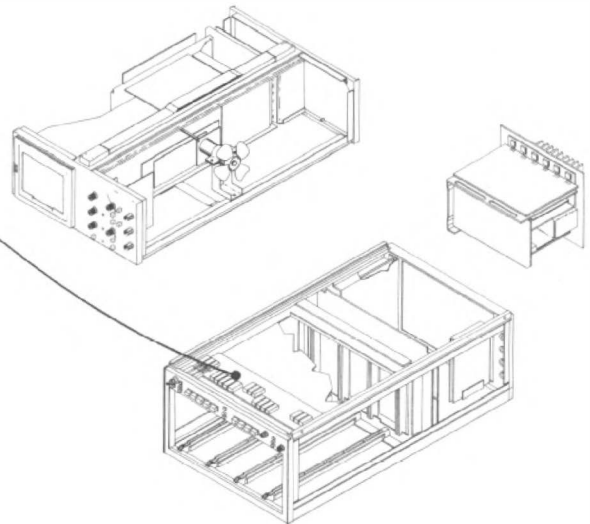
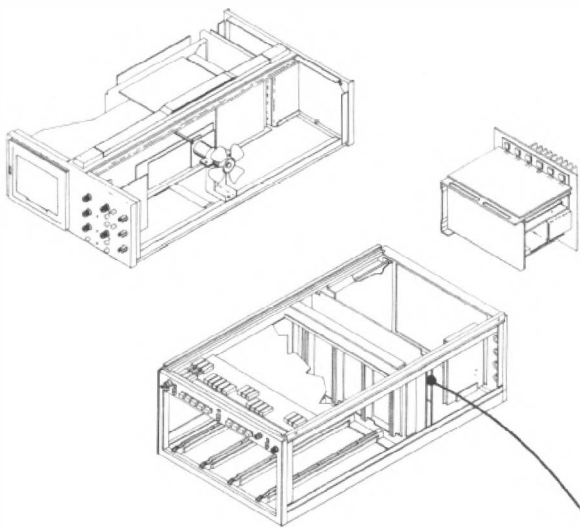

Figure 8-24. Adjustment Locations C.

**A5
MODE SWITCH
BOARD**
*Shown in diags.
2, 7*





**A14
TRIGGER SELECTOR
BOARD**
*Shown in diags.
2, 5*

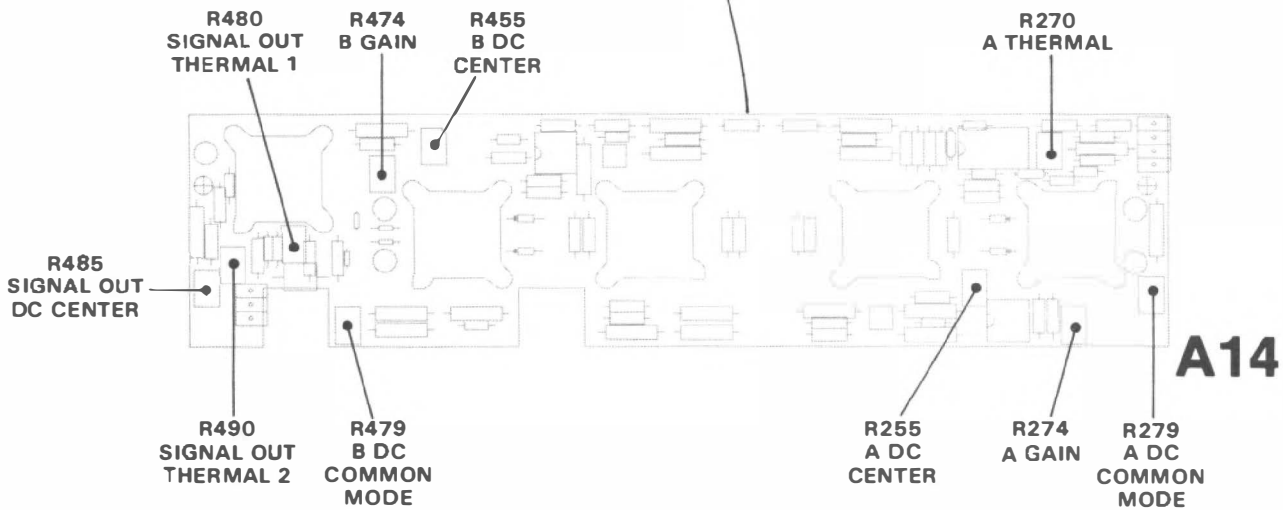
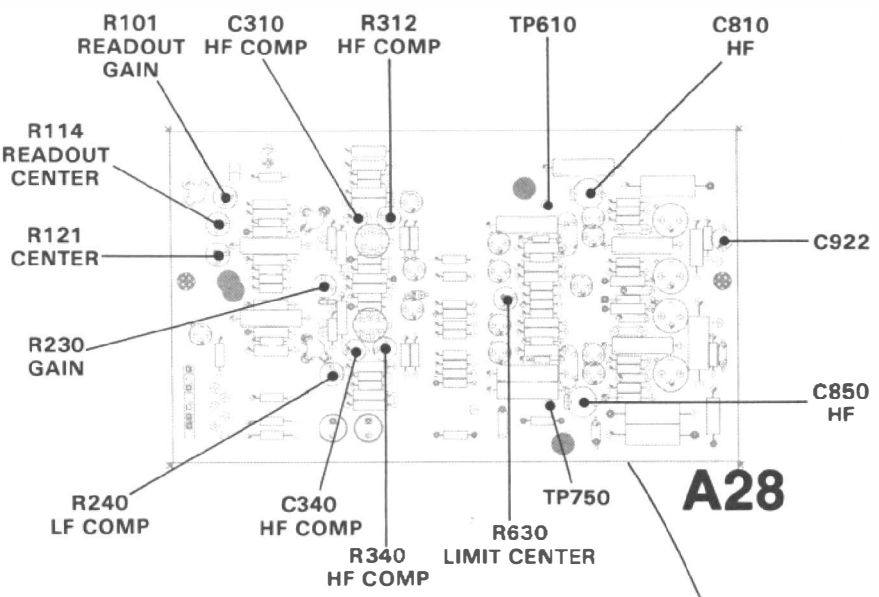
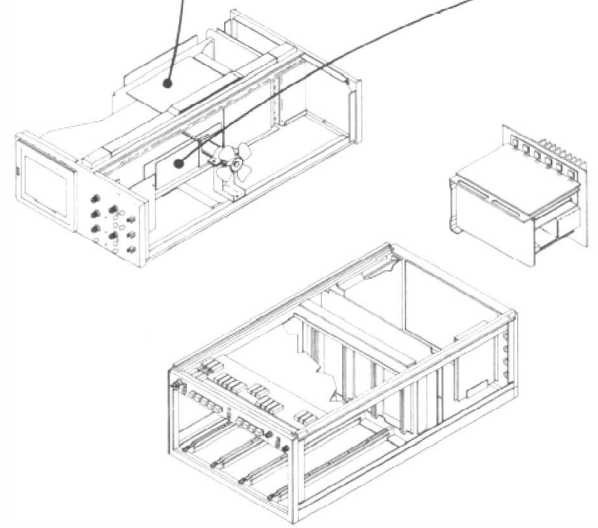

Figure 8-25. Adjustment Locations D.



A28
HORIZONTAL AMPLIFIER BOARD
 Shown in diag. 11



A17
(Option 2)
X-Y DELAY COMPENSATION BOARD
 Shown in diag. 10

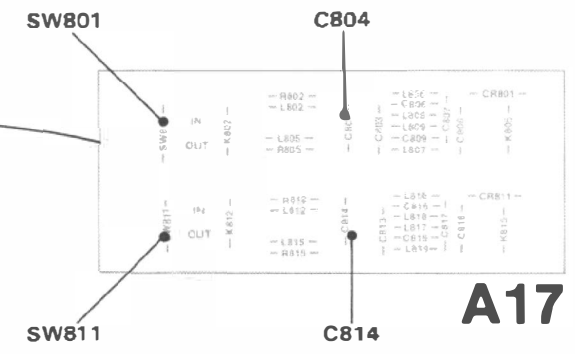
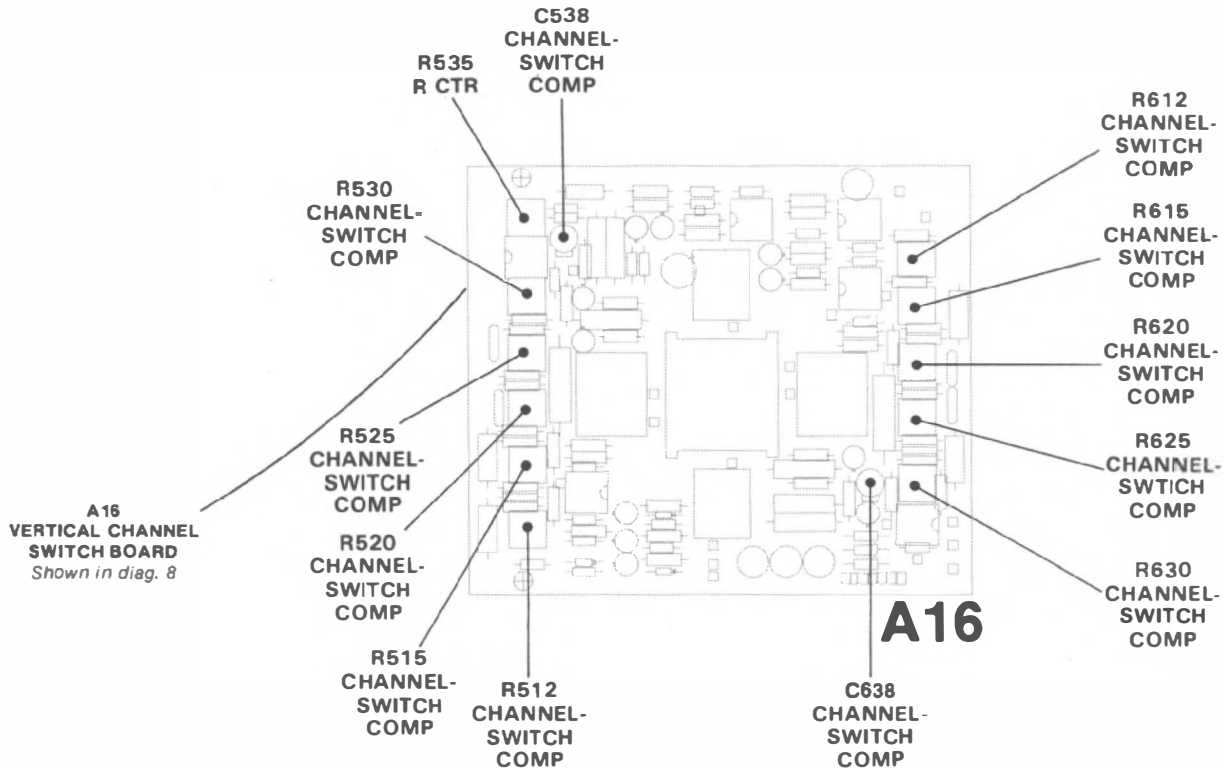
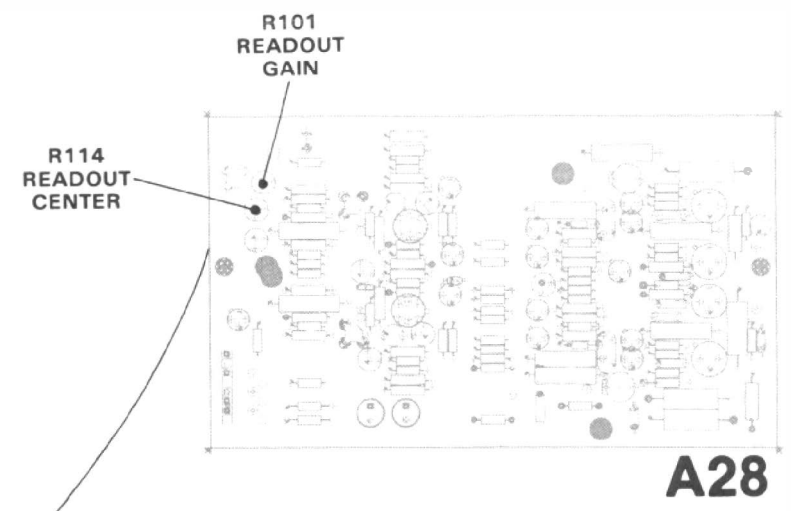
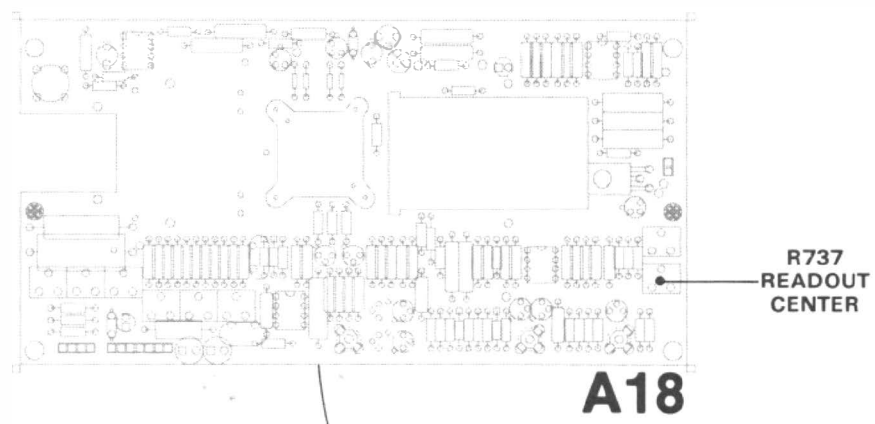

Figure 8-26. Test Point and Adjustment Locations E.





A18
VERTICAL AMPLIFIER
BOARD
Shown in diag. 9

A28
HORIZONTAL AMPLIFIER
BOARD
Shown in diag. 11

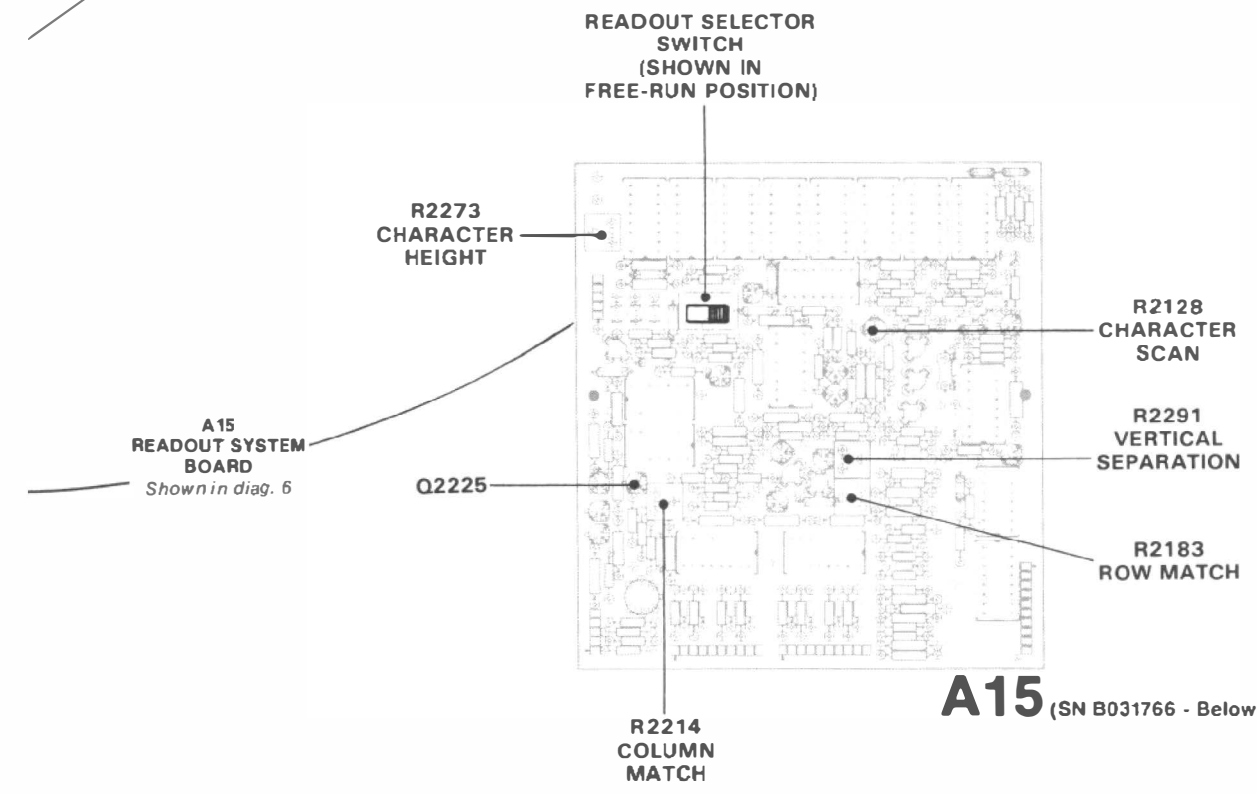
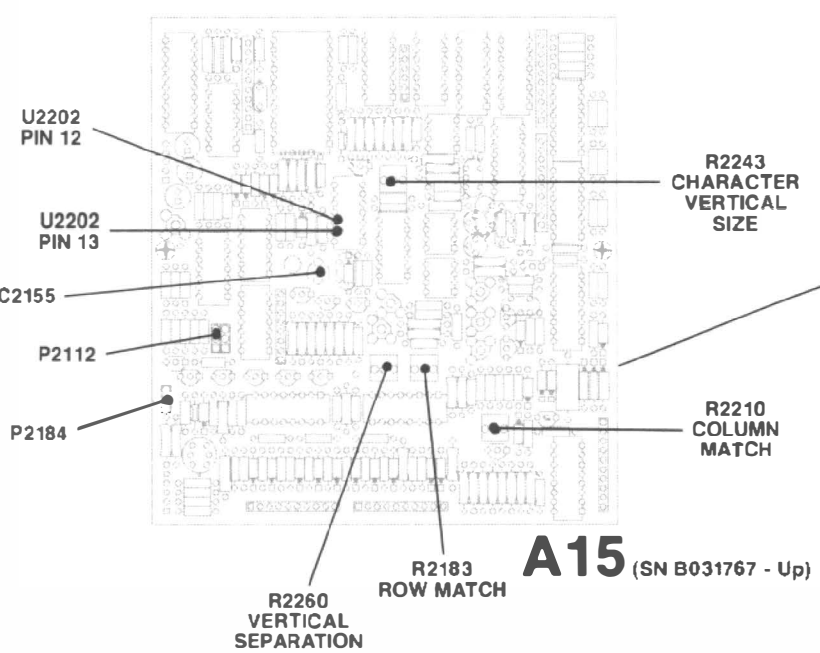

A15
READOUT SYSTEM
BOARD
Shown in diag. 6

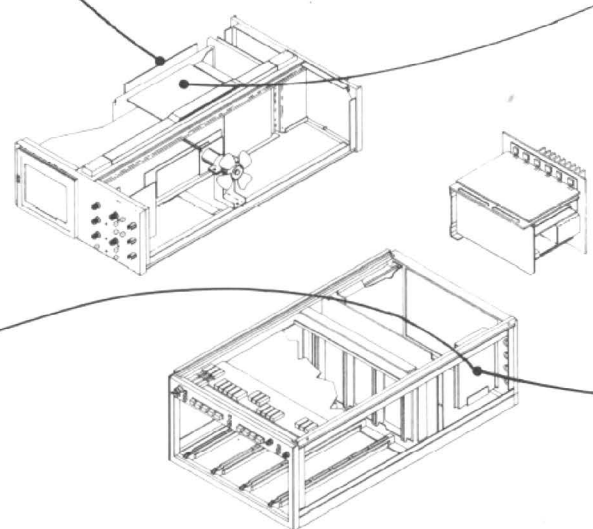

Figure 8-28. Test Point and Adjustment Locations G.

REPLACEABLE MECHANICAL PARTS

PARTS ORDERING INFORMATION

Replacement parts are available from or through your local Tektronix, Inc. Field Office or representative

Changes to Tektronix instruments are sometimes made to accommodate improved components as they become available, and to give you the benefit of the latest circuit improvements developed in our engineering department. It is therefore important when ordering parts, to include the following information in your order: Part number, instrument type or number, serial number and modification number if applicable.

If a part you have ordered has been replaced with a new or improved part, your local Tektronix, Inc. Field Office or representative will contact you concerning any change in part number.

Change information, if any, is located at the rear of this manual.

ITEM NAME

In the Parts List, an Item Name is separated from the description by a colon (:). Because of space limitations, an Item Name may sometimes appear as incomplete. For further Item Name identification, the U.S. Federal Cataloging Handbook H6-1 can be utilized where possible.

FIGURE AND INDEX NUMBERS

Items in this section are referenced by figure and index numbers to the illustrations.

INDENTATION SYSTEM

This mechanical parts list is indented to indicate item relationships. Following is an example of the indentation system used in the description column:

```

1 2 3 4 5           Name & Description
Assembly and/or Component
Attaching parts for Assembly and/or Component
    - - - * - - -
Detail Part of Assembly and/or Component
Attaching parts for Detail Part
    - - - * - - -
Parts of Detail Part
Attaching parts for Parts of Detail Part
    - - - * - - -
    
```

Attaching Parts always appear in the same indentation as the item it mounts, while the detail parts are indented to the right. Indented items are part of, and included with, the next higher indentation. The separation symbol - - - * - - - indicates the end of attaching parts.

Attaching parts must be purchased separately, unless otherwise specified.

ABBREVIATIONS

| | | | | | | |
|------------------------|---------|-----------------------|----------|----------------------|---------|-----------------|
| INCH | ELECTRN | ELECTRON | IN | INCH | SE | SINGLE END |
| ■ NUMBER SIZE | ELEC | ELECTRICAL | INCAND | INCANDESCENT | SECT | SECTION |
| ACTR ACTUATOR | ELCTLT | ELECTROLYTIC | INSUL | INSULATOR | SEMICON | SEMICONDUCTOR |
| ADPTR ADAPTER | ELEM | ELEMENT | INTL | INTERNAL | SHLD | SHIELD |
| ALIGN ALIGNMENT | EPL | ELECTRICAL PARTS LIST | LPHLDR | LAMPHOLDER | SHLDR | SHOULDERED |
| AL ALUMINUM | EQPT | EQUIPMENT | MACH | MACHINE | SKT | SOCKET |
| ASSEM ASSEMBLED | EXT | EXTERNAL | MECH | MECHANICAL | SL | SLIDE |
| ASSY ASSEMBLY | FIL | FILLISTER HEAD | MTG | MOUNTING | SLFLKG | SELF-LOCKING |
| ATTEN ATTENUATOR | FLEX | FLEXIBLE | NIP | NIPPLE | SLVG | SLEEVING |
| AWG AMERICAN WIRE GAGE | FLH | FLAT HEAD | NON WIRE | NOT WIRE WOUND | SPR | SPRING |
| BD BOARD | FLTR | FILTER | OBD | ORDER BY DESCRIPTION | SO | SQUARE |
| BRKT BRACKET | FR | FRAME or FRONT | OD | OUTSIDE DIAMETER | SST | STAINLESS STEEL |
| BRS BRASS | FSTNR | FASTENER | OVH | OVAL HEAD | STL | STEEL |
| BRZ BRONZE | FT | FOOT | PH BRZ | PHOSPHOR BRONZE | SW | SWITCH |
| BSHG BUSHING | FXD | FIXED | PL | PLAIN or PLATE | T | TUBE |
| CAB CABINET | GSKT | GASKET | PLSTC | PLASTIC | TERM | TERMINAL |
| CAP CAPACITOR | HDL | HANDLE | PN | PART NUMBER | THD | THREAD |
| CER CERAMIC | HEX | HEXAGON | PNH | PAN HEAD | THK | THICK |
| CHAS CHASSIS | HEX HD | HEXAGONAL HEAD | PWR | POWER | TNSN | TENSION |
| CKT CIRCUIT | HEX SOC | HEXAGONAL SOCKET | RCPT | RECEPTACLE | TPG | TAPPING |
| COMP COMPOSITION | HLCPS | HELICAL COMPRESSION | RES | RESISTOR | TRH | TRUSS HEAD |
| CONN CONNECTOR | HLEXT | HELICAL EXTENSION | RGD | RIGID | V | VOLTAGE |
| COV COVER | HV | HIGH VOLTAGE | RLF | RELIEF | VAR | VARIABLE |
| CPLG COUPLING | IC | INTEGRATED CIRCUIT | RTNR | RETAINER | W | WITH |
| CRT CATHODE RAY TUBE | ID | INSIDE DIAMETER | SCH | SOCKET HEAD | WSHR | WASHER |
| DEG DEGREE | IDENT | IDENTIFICATION | SCOPE | OSCILLOSCOPE | XFMR | TRANSFORMER |
| DWR DRAWER | IMPLR | IMPELLER | SCR | SCREW | XSTR | TRANSISTOR |

CROSS INDEX - MFR. CODE NUMBER TO MANUFACTURER

| Mfr. Code | Manufacturer | Address | City, State, Zip Code |
|-----------|---|--|---------------------------------|
| 00779 | AMP INC | 2800 FULLING MILL PO BOX 3608 | HARRISBURG PA 17105 |
| 01295 | TEXAS INSTRUMENTS INC SEMICONDUCTOR GROUP | 13500 N CENTRAL EXPY PO BOX 655012 | DALLAS TX 75265 |
| 01536 | TEXTRON INC CAMCAR DIV | 1818 CHRISTINA ST | ROCKFORD IL 61108 |
| 02768 | SEMS PRODUCTS UNIT ILLINOIS TOOL WORKS INC FASTEX DIVISION | 195 ALGONQUIN ROAD | DES PLAINES IL 60016-6103 |
| 04811 | PRECISION COIL SPRING CO | 10107 ROSE ST PO BOX 5450 | EL MONTE CA 91734 |
| 04963 | MINNESOTA MINING AND MFG CO ADHESIVES COATINGS AND SEALERS DIV | 3M CENTER | ST PAUL MN 55111-1428 |
| 06383 | PANDUIT CORP | 17301 RIDGELAND | TINLEY PARK IL 07094-2917 |
| 06776 | ROBINSON NUGENT INC | 800 E 8TH ST PO BOX 1208 | NEW ALBANY IN 47150-3264 |
| 06915 | RICHCO PLASTIC CO | 5825 N TRIPP AVE | CHICAGO IL 60646-6013 |
| 06950 | SCREWCORP VSI AEROSPACE PRODUCTS DIV SUB OF FAIRCHILD INDUSTRIES INC | 13001 E TEMPLE AVE PO BOX 730 | CITY OF INDUSTRY CA 91746-1417 |
| 07416 | NELSON NAME PLATE CO | 3191 CASITAS | LOS ANGELES CA 90039-2410 |
| 07700 | TECHNICAL WIRE PRODUCTS INC DBA TECKNIT INC | 129 DERMODY ST | CRANFORD NJ 07016-3217 |
| 07707 | USM CORP SUB OF EMMART INDUSTRIES INC USM FASTENER DIV | 510 RIVER RD | SHELTON CT 06848-4517 |
| 08261 | SPECTRA-STRIP AN ELTRA CO | 7100 LAMPSON AVE | GARDEN GROVE CA 92642 |
| 09772 | WEST COAST LOCKWASHER CO INC | 16730 E JOHNSON DRIVE P O BOX 3588 | CITY OF INDUSTRY CA 91744 |
| 09922 | BURNDY CORP | RICHARDS AVE | NORWALK CT 06852 |
| 11897 | PLASTIGLIDE MFG CORP | 2701 W EL SEGUNDO BLVD | HAWTHORNE CA 90250-3318 |
| 12327 | FREEWAY CORP | 9301 ALLEN DR | CLEVELAND OH 44125-4632 |
| 12360 | ALBANY FASTENERS PAWTUCKET FASTENER DIV | 327 PINE ST PO BOX 879 | PAWTUCKET RI 02862 |
| 13103 | THERMALLOY CO INC | 2021 W VALLEY VIEW LN PO BOX 810839 | DALLAS TX 75381 |
| 13511 | AMPHENOL CADRE DIV BUNKER RAMO CORP | | LOS GATOS CA |
| 16428 | COOPER BELDEN ELECTRONIC WIRE AND CA SUB OF COOPER INDUSTRIES INC | NW N ST | RICHMOND IN 47374 |
| 18565 | CHOMERICS INC | 77 DRAGON COURT | WOBURN MA 01801-1039 |
| 22526 | DU PONT E I DE NEMOURS AND CO INC DU PONT CONNECTOR SYSTEMS DIV MILITARY PRODUCTS GROUP | 515 FISHING CREEK RD | NEW CUMBERLAND PA 17070-3007 |
| 24931 | SPECIALTY CONNECTOR CO INC | 2100 EARLYWOOD DR PO BOX 547 | FRANKLIN IN 46131 |
| 26365 | GRIES DYNACAST CO DIV OF COATS AND CLARK INC | 125 BEECHWOOD AVE | NEW ROCHELLE NY 10802 |
| 28520 | HEYCO MOLDED PRODUCTS | 750 BOULEVARD P O BOX 160 | KENILWORTH NJ 07033-1721 |
| 30817 | INSTRUMENT SPECIALTIES CO INC | EXIT 53 RT 80 BOX A | DELAWARE WATER GAP PA 18327 |
| 46384 | PENN ENGINEERING AND MFG CORP | OLD EASTON RD PO BOX 1000 | DANBORO PA 18916 |
| 52792 | THORGREN TOOL AND MOLDING CO INC | 1100 EVANS AVE PO BOX 210 | VALPARAISO IN 46383-3717 |
| 70485 | ATLANTIC INDIA RUBBER WORKS INC | 571 W POLK ST | CHICAGO IL 60607 |
| 70903 | COOPER BELDEN ELECTRONICS WIRE AND C SUB OF COOPER INDUSTRIES INC | 2000 S BATAVIA AVE | GENEVA IL 60134-3325 |
| 71159 | BRISTOL SOCKET SCREW CO | | WATERBURY CT |
| 71590 | MEPCO/CENTRALAB INC A NORTH AMERICAN PHILIPS CO | HWY 20 W PO BOX 858 | FORT DODGE IA 50501 |
| 71785 | CINCH CONNECTORS | 1501 MORSE AVE | ELK GROVE VILLAGE IL 60007-5723 |
| 73743 | FISCHER SPECIAL MFG CO | 111 INDUSTRIAL RD | COLD SPRING KY 41076-9749 |
| 74445 | HOLO-KROME CO | 31 BROOK ST | ELMWOOD CT 06110-2350 |

CROSS INDEX - MFR. CODE NUMBER TO MANUFACTURER

| Mfr. Code | Manufacturer | Address | City, State, Zip Code |
|-----------|---|--------------------------------------|----------------------------|
| 77900 | ILLINOIS TOOL WORKS SHAKEPROOF DIV | ST CHARLES RD | ELGIN IL 60120 |
| 78189 | ILLINOIS TOOL WORKS INC SHAKEPROOF DIV | ST CHARLES ROAD | ELGIN IL 60120 |
| 80009 | TEKTRONIX INC | 14150 SW KARL BRAUN DR PO BOX 500 | BEAVERTON OR 97077-0001 |
| 80033 | MICRODOT MFG INC PRESTOLE EVERLOCK DIV | 1345 MIAMI ST P O BOX 278 | TOLEDO OH 43605 |
| 81350 | JOINT ARMY-NAVY SPECIFICATIONS, PROMULGATED BY MILITARY DEPARTMENTS UNDER AUTHORITY OF DEFENSE STANDARD- IZATION MANUAL 4120 3-M | | |
| 83385 | MICRODOT MFG INC GREER-CENTRAL DIV | 3221 W BIG BEAVER RD | TROY MI 48098 |
| 83553 | ASSOCIATED SPRING BARNES GROUP INC | 15001 S BROADWAY P O BOX 231 | GARDENA CA 90248-1819 |
| 85471 | BOYD CORP | 13885 RAMOMA AVE | CHINO CA 91710 |
| 85480 | BRADY W H CO CORP H Q INDUSTRIAL PRODUCTS DIV | 2221 W CAMDEN RD PO BOX 2131 | MILWAUKEE WI 53209 |
| 86928 | SEASTROM MFG CO INC | 701 SONORA AVE | GLENDALE CA 91201-2431 |
| 87308 | FARLEY METALS INC SOUTHERN SCREW DIV | BARKLEY RD P O BOX 1360 | STATESVILLE NC 28677-9774 |
| 91500 | ASHEVILLE-SCHOONMAKER MICA CO | 910 JEFFERSON AVE P O BOX 318 | NEWPORT NEWS VA 23607-6120 |
| 91836 | KINGS ELECTRONICS CO INC | 40 MARBLEDALE ROAD | TUCKAHOE NY 10707-3420 |
| 93907 | TEXTRON INC CAMCAR DIV | 600 18TH AVE | ROCKFORD IL 61108-5181 |
| 95987 | BRADY/WECKESSER MFG CO | 4444 WEST IRVING PARK RD | CHICAGO IL 60611 |
| 98159 | RUBBER TECK INC | 19115 HAMILTON AVE PO BOX 389 | GARDENA CA 90247 |
| 98291 | SEAELECTRO CORP BICC ELECTRONICS | 40 LINDEMAN DR | TURNBULL CT 06811-4739 |
| 98978 | INTERNATIONAL ELECTRONIC RESEARCH CORP | 135 W MAGNOLIA BLVD PO BOX 7704 | BURBANK CA 91502 |
| S3109 | FELLER | ASA ADOLF AG STOTZWEID CH8810 | HORGEN SWITZERLAND |
| S3629 | SCHURTER AG H C/O PANEL COMPONENTS CORP | 2015 SECOND STREET | BERKELEY CA 94701 |
| TK0428 | DLB INDUSTRIES | | FRESNO CA |
| TK0433 | PORTLAND SCREW CO | 6520 N BASIN | PORTLAND OR 97217-3920 |
| TK0435 | LEWIS SCREW CO | 4300 S RACINE AVE | CHICAGO IL 60619-3320 |
| TK0861 | H SCHURTER AG DIST PANEL COMPONENTS | 2015 SECOND STREET | BERKELEY CA 94701 |
| TK1281 | MICRO PLASTICS INC | HWY 178 NORTH | FLIPPIN AR 72634 |
| TK1316 | BOYD CORP | 6136 NE 87TH AVE PO BOX 20038 | PORTLAND OR 97220 |
| TK1373 | PATELEC-CEM (ITALY) | 10156 TORINO | VAICENTALLO 62145S ITALY |
| TK1465 | BEAVERTON PARTS MFG CO | 1800 NW 216TH AVE | HILLSBORO OR 97124-6629 |
| TK1543 | CAMCAR/TEXTRON | 600 18TH AVE | ROCKFORD IL 61108-5181 |
| TK2165 | TRIQUEST CORP | 3000 LEWIS AND CLARK HWY | VANCOUVER WA 98661-2999 |

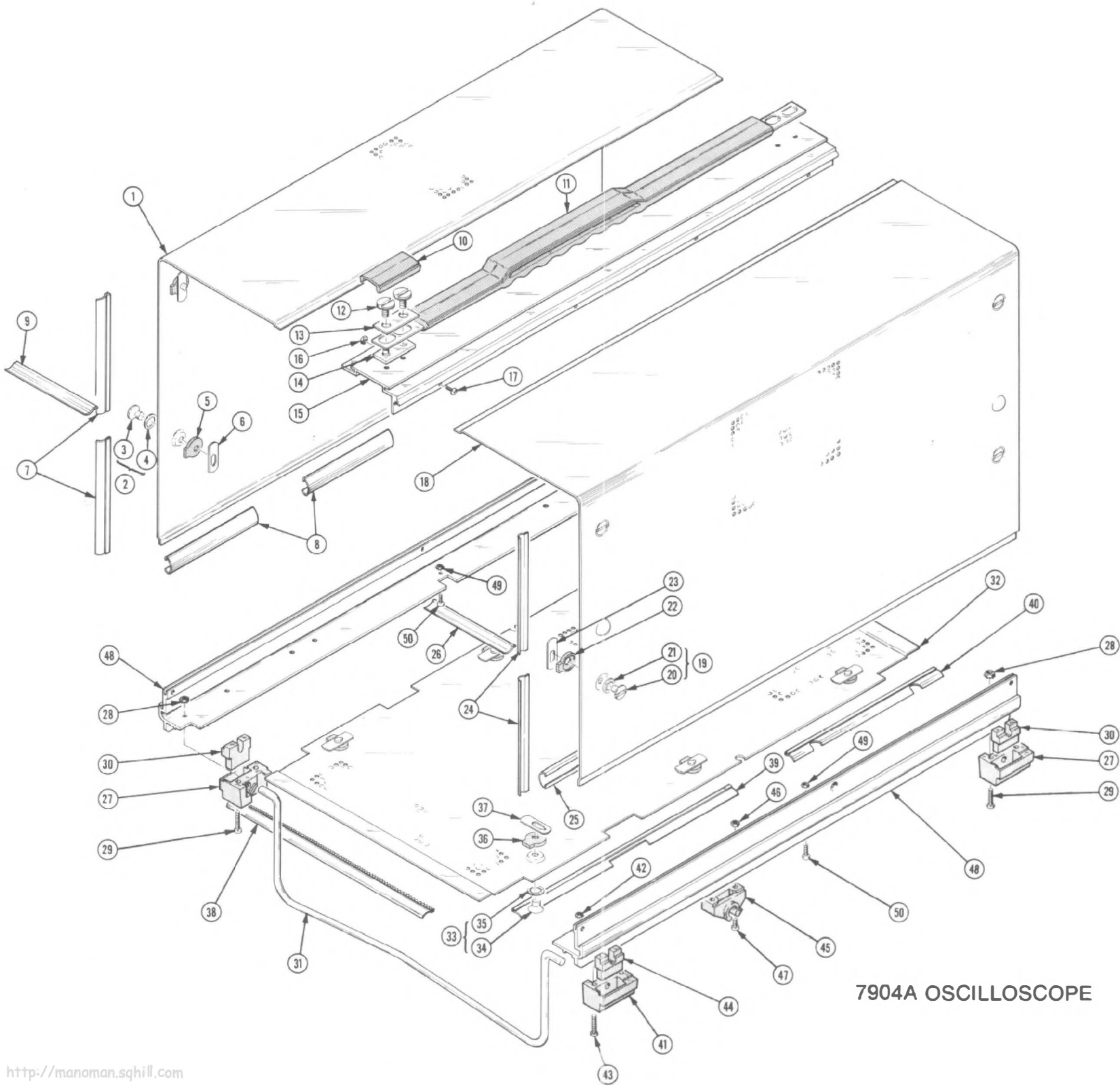

7904A OSCILLOSCOPE

Replaceable Mechanical Parts - 7904A

| Fig. & Index No. | Tektronix Part No. | Serial/Assembly No. Effective Dscnt | Qty | 12345 Name & Description | Mfr. Code | Mfr. Part No. |
|------------------|--------------------|-------------------------------------|-----|--|-----------|----------------|
| 1-1 | 390-0693-01 | | 1 | CAB. SIDE, SCOPE: LEFT | 80009 | 390-0693-01 |
| | 390-0696-01 | | 1 | CAB. SIDE, SCOPE: LEFT, EMI (OPTION 03 ONLY) | 80009 | 390-0696-01 |
| -2 | 214-0603-02 | | 4 | .PIN ASSY, SECRG: W/SPRING WASHER | 80009 | 214-0603-02 |
| -3 | 214-0603-01 | | 4 | ..PIN, SECURING: 0.45 DIA X 0.27, ZAMAK CD PL | 80009 | 214-0603-01 |
| -4 | 214-0604-00 | | 4 | ..WASHER, SPR TNSN: 0.26 ID X 0.47 OD, SST | 80009 | 214-0604-00 |
| -5 | 386-0227-00 | | 4 | .STOP, CLP, RIM CL: | 80009 | 386-0227-00 |
| | 386-1634-00 | | 4 | .PLATE, LCH INDEX: ACETAL (OPTION 03 ONLY) | TK2165 | 386-1634-00 |
| -6 | 386-1151-00 | | 4 | .CLAMP, RIM CLENC: SPG STL CD PL | 83553 | ORDER BY DESCR |
| | 386-1633-00 | | 4 | .PLATE, LCH LKG: STEEL, CD PL (OPTION 03 ONLY) | 80009 | 386-1633-00 |
| -7 | 348-0333-00 | | 4 | .SHLD GSKT, ELEK: SOLID TYPE, 4.8 L (OPTION 03 ONLY) | 80009 | 348-0333-00 |
| -8 | 348-0336-00 | | 4 | .SHLD GSKT, ELEK: SOLID TYPE, 9.625 L (OPTION 03 ONLY) | 80009 | 348-0336-00 |
| -9 | 348-0332-00 | | 2 | .SHLD GSKT, ELEK: SOLID TYPE, 4.285 L (OPTION 03 ONLY) | 80009 | 348-0332-00 |
| -10 | 200-0728-00 | | 2 | COVER, HDL END: 1.91 X 0.91 X 0.36 BLUE | 80009 | 200-0728-00 |
| -11 | 367-0108-00 | | 1 | HANDLE, CARRYING: 19.19 L, BLUE VINYL (ATTACHING PARTS) | 80009 | 367-0108-00 |
| -12 | 212-0628-00 | | 4 | SCREW, SHOULDER: 10-32 X 0.4 L, RDH, STL | TK1543 | ORDER BY DESCR |
| -13 | 386-1624-00 | | 2 | PLATE, HDL RTNG: STAINLESS STEEL (END ATTACHING PARTS) | 80009 | 386-1624-00 |
| -14 | 386-1283-01 | | 2 | PLATE, HDL MTG: FRONT | 80009 | 386-1283-01 |
| -15 | 426-0819-01 | | 1 | FRAME SECT, CAB.: TOP CENTER (ATTACHING PARTS) | 80009 | 426-0819-01 |
| -16 | 210-0457-00 | | 4 | NUT, PL, ASSEM WA: 6-32 X 0.312, STL CD PL | 78189 | 511-061800-00 |
| -17 | 211-0507-00 | | 4 | SCREW, MACHINE: 6-32 X 0.312, PNH, STL (END ATTACHING PARTS) | 83385 | ORDER BY DESCR |
| -18 | 390-0548-00 | | 1 | CAB. SIDE, SCOPE: RIGHT | 80009 | 390-0548-00 |
| | 390-0551-00 | | 1 | CAB. SIDE, SCOPE: RIGHT, W/SHIELDING GASKET (OPTION 03 ONLY) | 80009 | 390-0551-00 |
| -19 | 214-0603-02 | | 4 | .PIN ASSY, SECRG: W/SPRING WASHER | 80009 | 214-0603-02 |
| -20 | 214-0603-01 | | 4 | ..PIN, SECURING: 0.45 DIA X 0.27, ZAMAK CD PL | 80009 | 214-0603-01 |
| -21 | 214-0604-00 | | 4 | ..WASHER, SPR TNSN: 0.26 ID X 0.47 OD, SST | 80009 | 214-0604-00 |
| -22 | 386-0227-00 | | 4 | .STOP, CLP, RIM CL: | 80009 | 386-0227-00 |
| -23 | 386-1151-00 | | 4 | .CLAMP, RIM CLENC: SPG STL CD PL | 83553 | ORDER BY DESCR |
| -24 | 348-0333-00 | | 4 | .SHLD GSKT, ELEK: SOLID TYPE, 4.8 L (OPTION 03 ONLY) | 80009 | 348-0333-00 |
| -25 | 348-0336-00 | | 4 | .SHLD GSKT, ELEK: SOLID TYPE, 9.625 L (OPTION 03 ONLY) | 80009 | 348-0336-00 |
| -26 | 348-0332-00 | | 2 | .SHLD GSKT, ELEK: SOLID TYPE, 4.285 L (OPTION 03 ONLY) | 80009 | 348-0332-00 |
| -27 | 348-0073-01 | | 2 | HINGE BLOCK, STA: L FR, R REAR, BLACK ACETAL (ATTACHING PARTS) | 80009 | 348-0073-01 |
| -28 | 210-0457-00 | | 4 | NUT, PL, ASSEM WA: 6-32 X 0.312, STL CD PL | 78189 | 511-061800-00 |
| -29 | 211-0532-00 | | 4 | SCREW, MACHINE: 6-32 X .750, FILH, STL (END ATTACHING PARTS) | 93907 | ORDER BY DESCR |
| -30 | 377-0119-00 | | 4 | INSERT, FOOT: 0.352 X 0.832 X 0.934, PU | 80009 | 377-0119-00 |
| -31 | 348-0193-00 | | 1 | FLIP-STANO, CAB.: 3.438 H, SST | 80009 | 348-0193-00 |
| -32 | 390-0555-00 | | 1 | CAB. BOT, SCOPE: | 80009 | 390-0555-00 |
| | 390-0554-00 | | 1 | CAB. BOT, SCOPE: (OPTION 03 ONLY) | 80009 | 390-0554-00 |
| -33 | 214-0603-02 | | 6 | .PIN ASSY, SECRG: W/SPRING WASHER | 80009 | 214-0603-02 |
| -34 | 214-0603-01 | | 4 | ..PIN, SECURING: 0.45 DIA X 0.27, ZAMAK CD PL | 80009 | 214-0603-01 |
| -35 | 214-0604-00 | | 4 | ..WASHER, SPR TNSN: 0.26 ID X 0.47 OD, SST | 80009 | 214-0604-00 |
| -36 | 386-0227-00 | | 4 | .STOP, CLP, RIM CL: | 80009 | 386-0227-00 |
| -37 | 386-1151-00 | | 4 | .CLAMP, RIM CLENC: SPG STL CD PL | 83553 | ORDER BY DESCR |
| -38 | 348-0274-00 | | AR | .SHLD GSKT, ELEK: FINGER TYPE, 24.0 L (OPTION 03 ONLY) | 30817 | 97-555CDC |
| -39 | 348-0335-00 | | 2 | .SHLD GSKT, ELEK: SOLID TYPE, 8.65 L (OPTION 03 ONLY) | 80009 | 348-0335-00 |
| -40 | 348-0334-00 | | 2 | .SHLD GSKT, ELEK: SOLID TYPE, 7.64 L (OPTION 03 ONLY) | 80009 | 348-0334-00 |
| -41 | 348-0074-01 | | 2 | HINGE BLOCK, STA: R FR, L REAR, BLACK ACETAL (ATTACHING PARTS) | 80009 | 348-0074-01 |
| -42 | 210-0457-00 | | 4 | NUT, PL, ASSEM WA: 6-32 X 0.312, STL CD PL | 78189 | 511-061800-00 |

| Fig. & Index No. | Tektronix Part No. | Serial/Assembly No. | | Qty | 12345 Name & Description | Mfr. | |
|------------------------|-----------------------|---------------------|---------|-----|---|-------|----------------|
| | | Effective | Discont | | | Code | Mfr. Part No. |
| 1-43 | 211-0532-00 | | | 4 | SCREW,MACHINE:6-32 X .750,FILH,STL (END ATTACHING PARTS) | 93907 | ORDER BY DESCR |
| -44 | 377-0119-00 | | | 2 | INSERT,FOOT:0.352 X 0.832 X 0.934,PU | 80009 | 377-0119-00 |
| -45 | 343-0256-00 | | | 2 | RTNR BLK,SCOPE:PLASTIC (ATTACHING PARTS) | 80009 | 343-0256-00 |
| -46 | 210-0457-00 | | | 4 | NUT,PL,ASSEM WA:6-32 X 0.312,STL CD PL | 78189 | 511-061800-00 |
| -47 | 213-0192-00 | | | 4 | SCREW,TPG,TF:6-32 X 0.5,SPCL TYPE,FILH,STL (END ATTACHING PARTS) | 87308 | ORDER BY DESCR |
| -48 | 426-0814-00 | | | 2 | FRAME SECT,CAB.:BOTTOM LEFT & RIGHT (ATTACHING PARTS) | 80009 | 426-0814-00 |
| -49 | 210-0457-00 | | | 2 | NUT,PL,ASSEM WA:6-32 X 0.312,STL CD PL | 78189 | 511-061800-00 |
| -50 | 211-0507-00 | | | 2 | SCREW,MACHINE:6-32 X 0.312,PNH,STL (END ATTACHING PARTS) | 83385 | ORDER BY DESCR |

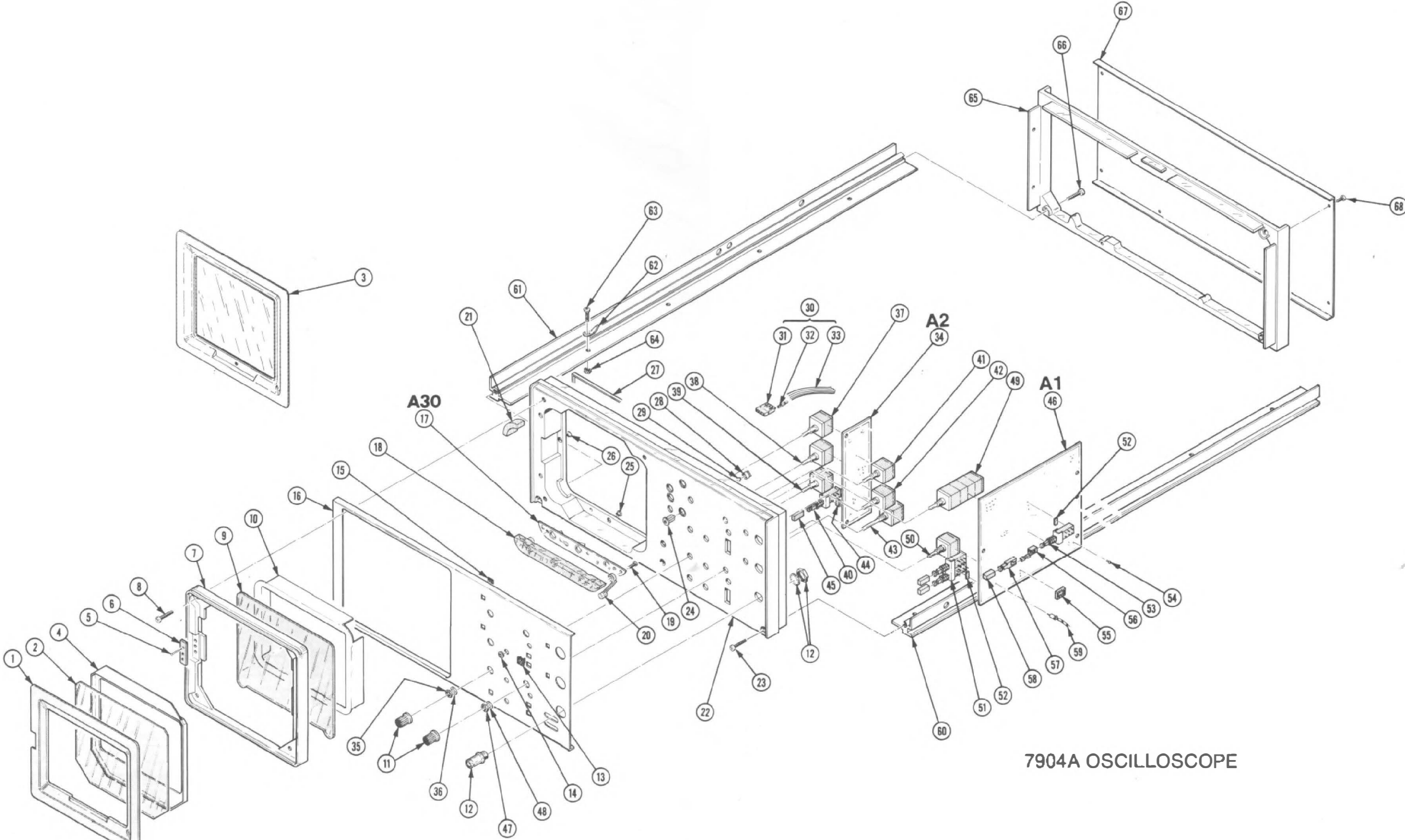

7904A OSCILLOSCOPE

| Fig. & Index No. | Tektronix Part No. | Serial/Assembly No. | | Qty | 12345 Name & Description | Mfr. | |
|------------------|--------------------|---------------------|--------|-----|---|--------|----------------|
| | | Effective | Discnt | | | Code | Mfr. Part No. |
| 2-1 | 426-0514-00 | | | 1 | FRAME,MASK: | 80009 | 426-0514-00 |
| -2 | 378-0625-00 | | | 1 | FILTER,LT,CRT:BLUE,5.15 X 4.4 X 0.03 | 80009 | 378-0625-00 |
| -3 | 378-0603-00 | | | 1 | FILTER,MESH:EMI (OPTION 03 ONLY) | 80009 | 378-0603-00 |
| -4 | 331-0258-03 | | | 1 | MASK,CRT SCALE: | 80009 | 331-0258-03 |
| -5 | ----- | | | 3 | TERM,FEED THRU:(SEE J130 REPL) | | |
| -6 | 204-0380-00 | | | 1 | BODY, TERMINAL: | 80009 | 204-0380-00 |
| -7 | 200-0939-01 | | | 1 | RTNR,CRT SCALE:5.55 X 5.068 X 0.475 (ATTACHING PARTS) | 80009 | 200-0939-01 |
| -8 | 212-0008-00 | | | 4 | SCREW,MACHINE:8-32 X 0.5,PNH,STL (END ATTACHING PARTS) | 83385 | ORDER BY DESCR |
| -9 | 337-1159-03 | | | 1 | SHLD,IMPLOSION:4.75 X 3.93 X 0.7 THK,PLSTC | 80009 | 337-1159-03 |
| -10 | 331-0245-00 | | | 1 | MASK,CRT SCALE: | 80009 | 331-0245-00 |
| -11 | 366-1189-00 | | | 5 | KNOB:GY,0.127 ID X 0.5 00 X 0.531 | 80009 | 366-1189-00 |
| | 213-0246-00 | | | 5 | .SETSCREW:5-40 X 0.094,STL | 71159 | ORDER BY DESCR |
| -12 | ----- | | | 3 | CONN,RCPT,BNC:(SEE J497,J1925,J1944 REPL) | | |
| -13 | 426-1072-00 | | | 7 | FRAME,PUSH BTN:SILVER GRAY PLSTC | 80009 | 426-1072-00 |
| -14 | 358-0301-02 | | | 5 | BUSHING,SLEEVE:0.16 ID X 0.205 OD | 80009 | 358-0301-02 |
| -15 | 378-0635-01 | | | 1 | LENS,LIGHT:WHITE,MARKED A | 80009 | 378-0635-01 |
| | 378-0635-02 | | | 1 | LENS,LIGHT:WHITE,MARKED B | 80009 | 378-0635-02 |
| -16 | 333-3043-00 | | | 1 | PANEL,FRONT:UPPER | 80009 | 333-3043-00 |
| -17 | ----- | | | 1 | CKT BOARD ASSY:GRATIULE LAMPS(SEE A30 REPL) | | |
| -18 | 378-0614-01 | | | 1 | .REFLECTOR,LIGHT:INT SCALE ILLUMINATION (ATTACHING PARTS) | 80009 | 378-0614-01 |
| -19 | 211-0162-00 | | | 2 | .SCREW,MACHINE:2-56 X 0.188,SCH,SST (END ATTACHING PARTS) | TK0428 | ORDER BY DESCR |
| -20 | 344-0179-00 | | | 2 | .CLIP,REFL RTNG:ACETAL,NAT | 80009 | 344-0179-00 |
| -21 | 134-0119-00 | | | 1 | BUTTON,PLUG:0.17 OD X 0.144,PLASTIC | 80009 | 134-0119-00 |
| -22 | 426-0808-10 | | | 1 | FRAME SECT,CAB.:FRONT (ATTACHING PARTS) | 80009 | 426-0808-10 |
| -23 | 213-0270-00 | | | 1 | SCR,TPG,TF:10-32 X 0.75,SPCL TYPE,FILH,STL (END ATTACHING PARTS) | TK1543 | 234-74658-026 |
| -24 | 352-0157-00 | | | 2 | LAMPHOLDER:(1)T-2 UNBASED,WHITE | 80009 | 352-0157-00 |
| -25 | 348-0031-00 | | | 1 | GROMMET,PLASTIC:0.127 ID,GRAY ACETAL | 80009 | 348-0031-00 |
| -26 | 348-0055-00 | | | 1 | GROMMET,PLASTIC:GRAY,ROUND,0.207 ID | 80009 | 348-0055-00 |
| -27 | 348-0216-00 | | | 1 | SHLD GSKT,ELEK:MESH TYPE,RING,5.25 ID | 07700 | 30-900 42 |
| -28 | 200-0935-00 | | | 1 | BASE,LAMPHOLDER:0.29 OD X 0.19 L,BK PLSTC | 80009 | 200-0935-00 |
| -29 | 331-0262-00 | | | 1 | DIFFUSER,LIGHT:INDICATOR LIGHTS | 80009 | 331-0262-00 |
| -30 | 175-8252-00 | | | 1 | CA ASSY,SP,ELEC:4,26 AWG,2.0 L,RIBBON (A,B LIGHTS TO A2P2003) | 80009 | 175-8252-00 |
| -31 | 131-0707-00 | | | 4 | .CONTACT,ELEC:22-26 AWG,BRS,CU BE GLD PL | 22526 | 47439-000 |
| -32 | 352-0162-00 | | | 1 | .HLDR,TERM CONN:4 WIRE,BLACK | 80009 | 352-0162-00 |
| -33 | 175-0827-00 | | | AR | .CABLE,SP,ELEC:4,26 AWG,STRD,PVC JKT,RBN | 08261 | 111-2699-954 |
| -34 | ----- | | | 1 | CKT BOARD ASSY:DISPLAY CONT(SEE A2 REPL) (ATTACHING PARTS) | | |
| -35 | 210-0583-00 | | | 3 | NUT,PLAIN,HEX:0.25-32 X 0.312,BRS CD PL | 73743 | 2X-20319-402 |
| -36 | 210-0940-00 | | | 3 | WASHER,FLAT:0.25 ID X 0.375 00 X 0.02,STL (END ATTACHING PARTS) | 12327 | ORDER BY DESCR |
| | | | | | DISPLAY CONTROL BOARD INCLUDES: | | |
| -37 | ----- | | | 1 | .RES,VAR:A(SEE R2010 REPL) | | |
| -38 | ----- | | | 1 | .RES,VAR:A(SEE R2020 REPL) | | |
| -39 | ----- | | | 1 | .RES,VAR:A(SEE R2005 REPL) | | |
| -40 | ----- | | | 1 | .SWITCH:BEAMFINDER(SEE S2005 REPL) | | |
| -41 | ----- | | | 1 | .RES,VAR:B CONTRAST(SEE R2015 REPL) | | |
| -42 | ----- | | | 1 | .RES,VAR:ASTIG(SEE R2025 REPL) | | |
| -43 | ----- | | | 1 | .RES,VAR:TRACE ROTATION(SEE R2035 REPL) | | |
| -44 | 361-0608-00 | | | 2 | .SPACER,PUSH SW:0.17 L,BRN POLYCARBONATE | 80009 | 361-0608-00 |
| -45 | 366-1559-00 | | | 1 | PUSH BUTTON:SIL GY,0.18 SQ X 0.43 | 80009 | 366-1559-00 |
| -46 | ----- | | | 1 | CKT BOARD ASSY:FRONT PANEL(SEE A1 REPL) (ATTACHING PARTS) | | |
| -47 | 210-0583-00 | | | 2 | NUT,PLAIN,HEX:0.25-32 X 0.312,BRS CD PL | 73743 | 2X-20319-402 |
| -48 | 210-0940-00 | | | 2 | WASHER,FLAT:0.25 ID X 0.375 00 X 0.02,STL (END ATTACHING PARTS) | 12327 | ORDER BY DESCR |
| | | | | | FRONT PANEL BOARD INCLUDES: | | |
| -49 | ----- | | | 1 | .RES,VAR:READOUT(SEE R1924 REPL) | | |
| -50 | ----- | | | 1 | .RES,VAR:GRAT ILLUM(SEE R1900 REPL) | | |
| -51 | ----- | | | 2 | .SWITCH,PUSH:(SEE S1905,S1915 REPL) | | |
| -52 | 361-0542-00 | | | 12 | .SPACER,PUSH SW:0.078 L,POLYPROPYLENE | 71590 | PCS-078 |

Replaceable Mechanical Parts - 7904A

| Fig. & Index No. | Tektronix Part No. | Serial/Assembly No. | | Qty | 12345 | Name & Description | Mfr. | |
|------------------------|-----------------------|---------------------|--------|-----|-------|---|--------|----------------|
| | | Effective | Discnt | | | | Code | Mfr. Part No. |
| 2-53 | ----- | | | 2 | | .SWITCH,PUSH:(SEE S1930,S1940 REPL) | | |
| -54 | 136-0252-07 | | | 4 | | .SOCKET,PIN CONN:W/O DIMPLE | 22526 | 75060-012 |
| -55 | 136-0727-00 | | | 1 | | .SKT,PL-IN ELEK:MICROCKT,8 CONTACT | 09922 | DILB8P-108 |
| -56 | 384-1354-00 | | | 2 | | EXTENSION SHAFT:1.585 L,OFFSET,NYLON | 80009 | 384-1354-00 |
| -57 | 384-1136-00 | | | 2 | | EXTENSION SHAFT:0.95 INCH LONG | 80009 | 384-1136-00 |
| -58 | 366-1559-00 | | | 6 | | PUSH BUTTON:SIL GY,0.18 SQ X 0.43 | 80009 | 366-1559-00 |
| -59 | 175-8238-00 | | | 1 | | CABLE ASSY,RF:50 OHM COAX,4.0 L,9-3 (A2J1943 TO +SAWTOOTH BNC) | 80009 | 175-8238-00 |
| | 175-8239-00 | | | 1 | | CABLE ASSY,RF:50 OHM COAX,3.0 L,9-3 (A2J194 TO +GATE BNC) | 80009 | 175-8239-00 |
| -60 | 426-1291-00 | | | 1 | | FRAME SECT,CAB.:BOTTOM | 80009 | 426-1291-00 |
| -61 | 426-1583-00 | | | 1 | | FRAME SECT,CAB.:BOTTOM LEFT | 80009 | 426-1583-00 |
| -62 | 210-0202-00 | | | 1 | | TERMINAL,LUG:0.146 ID,LOCKING,BRZ TIN PL (ATTACHING PARTS) | 86928 | A-373-158-2 |
| -63 | 211-0504-00 | | | 1 | | SCREW,MACHINE:6-32 X 0.250,PNH,STL | TK0435 | ORDER BY DESCR |
| -64 | 210-0586-00 | | | 1 | | NUT,PL,ASSEM WA:4-40 X 0.25,STL CD PL (END ATTACHING PARTS) | 78189 | 211-041800-00 |
| -65 | 426-0809-11 | | | 1 | | FRAME SECT,CAB.:UPPER REAR (ATTACHING PARTS) | 80009 | 426-0809-11 |
| -66 | 213-0270-00 | | | 3 | | SCR,TPG,TF:10-32 X 0.75,SPCL TYPE,FILH,STL (END ATTACHING PARTS) | TK1543 | 234-74658-026 |
| -67 | 386-2125-01 | | | 1 | | PANEL,REAR: (ATTACHING PARTS) | 80009 | 386-2125-01 |
| -68 | 211-0232-00 | | | 8 | | SCREW,MACHINE:4-40 X 0.25,FILH,STL (END ATTACHING PARTS) | TK0435 | 8005-302 |

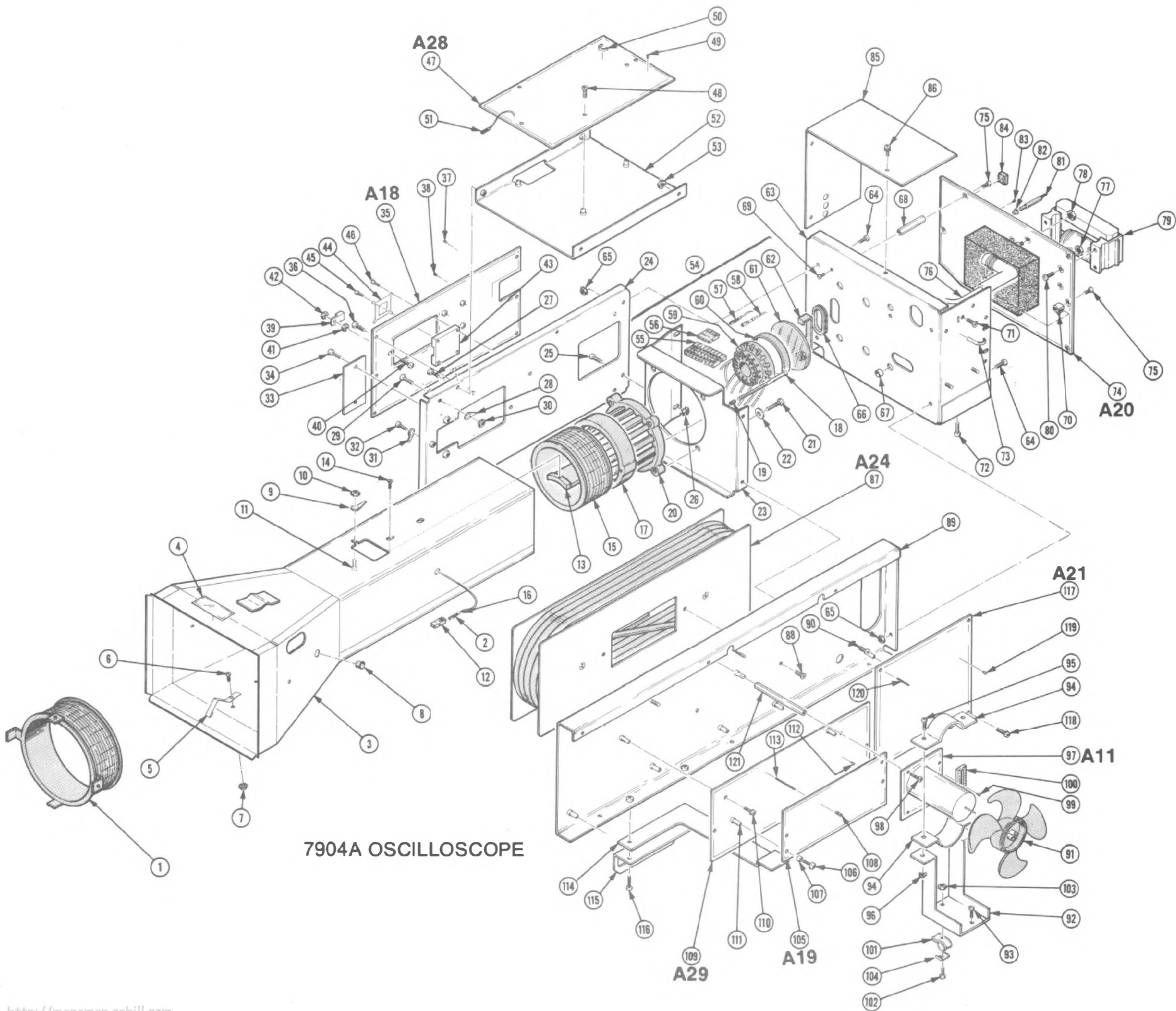

7904A OSCILLOSCOPE

| Fig. & Index No. | Tektronix Part No. | Serial/Assembly No. Effective | Discount | Qty | 12345 Name & Description | Mfr. Code | Mfr. Part No. |
|------------------|--------------------|-------------------------------|----------|-----|--|-----------|----------------|
| 3-1 | ----- | | | 1 | COIL:TRACE ROTATION(SEE L21 REPL) | | |
| -2 | 131-0707-00 | | | 2 | .CONTACT,ELEC:22-26 AWG,BRS,CU BE GLD PL | 22526 | 47439-000 |
| -3 | 337-1460-00 | | | 1 | SHIELD,CRT: | 80009 | 337-1460-00 |
| -4 | 334-1379-00 | | | 1 | MARKER,IDENT:MKD HI VACUUM | 07416 | ORDER BY DESCR |
| -5 | 214-0291-00 | | | 1 | CONTACT,ELEC:CRT CONNECTOR,CU BE SIL PL (ATTACHING PARTS) | 04811 | ORDER BY DESCR |
| -6 | 211-0168-00 | B010100 | B010114 | 1 | SCREW,MACHINE:4-40 X 0.25,PNH,BRS,NP | 12360 | ORDER BY DESCR |
| | 211-0007-00 | B010115 | | 1 | SCREW,MACHINE:4-40 X 0.188,PNH,STL | 93907 | ORDER BY DESCR |
| -7 | 210-0586-00 | | | 1 | NUT,PL,ASSEM WA:4-40 X 0.25,STL CD PL (END ATTACHING PARTS) | 78189 | 211-041800-00 |
| -8 | 348-0055-00 | | | 2 | GROMMET,PLASTIC:GRAY,ROUND,0.207 ID | 80009 | 348-0055-00 |
| -9 | 210-0201-00 | | | 1 | TERMINAL,LUG:0.12 ID,LOCKING,BRZ TIN PL (ATTACHING PARTS) | 86928 | A373-157-2 |
| -10 | 210-0586-00 | | | 1 | NUT,PL,ASSEM WA:4-40 X 0.25,STL CD PL | 78189 | 211-041800-00 |
| -11 | 211-0168-00 | B010100 | B010114 | 1 | SCREW,MACHINE:4-40 X 0.25,PNH,BRS,NP | 12360 | ORDER BY DESCR |
| | 211-0007-00 | B010115 | | 1 | SCREW,MACHINE:4-40 X 0.188,PNH,STL (END ATTACHING PARTS) | 93907 | ORDER BY DESCR |
| -12 | 352-0169-00 | | | 2 | HLDR,TERM CONN:2 WIRE,BLACK | 80009 | 352-0169-00 |
| -13 | 343-0217-00 | | | 1 | CLAMP,COIL:POLYPROPYLENE (ATTACHING PARTS) | 80009 | 343-0217-00 |
| -14 | 213-0138-00 | | | 2 | SCREW,TPG,TF:4-24 X 0.188,TYPE B,PNH,STL (END ATTACHING PARTS) | TK0435 | ORDER BY DESCR |
| -15 | ----- | | | 1 | COIL:Y AXIS(SEE L22 REPL) | | |
| -16 | 131-0707-00 | | | 2 | .CONTACT,ELEC:22-26 AWG,BRS,CU BE GLD PL | 22526 | 47439-000 |
| -17 | 354-0347-00 | | | 1 | RING,CRT CLAMP:2.127 ID X 2.595 OD X 0.563 (ATTACHING PARTS) | 80009 | 354-0347-00 |
| -18 | 211-0170-00 | | | 2 | SCREW,MACHINE:4-40 X 2.25,PNH,SST | 93907 | ORDER BY DESCR |
| -19 | 214-1333-00 | | | 2 | SPRING,HLCP:0.213 OD X 0.375,CLE,CU-BE (END ATTACHING PARTS) | 80009 | 214-1333-00 |
| -20 | 343-0205-01 | | | 1 | RTNR,ELCTR TU:3.0 DIA X 1.5 L,DELTRIN (ATTACHING PARTS) | 80009 | 343-0205-01 |
| -21 | 211-0510-00 | | | 4 | SCREW,MACHINE:6-32 X 0.375,PNH,STL | 83385 | ORDER BY DESCR |
| -22 | 210-0949-00 | | | 4 | WASHER,FLAT:0.141 ID X 0.5 OD X 0.062,BRS (END ATTACHING PARTS) | 12327 | ORDER BY DESCR |
| -23 | 386-4070-00 | | | 1 | SUPPORT,CRT:REAR,ALUMINUM | 80009 | 386-4070-00 |
| -24 | 441-1463-01 | | | 1 | CHASSIS,SCOPE:VERTICAL AMPLIFIER (ATTACHING PARTS) | 80009 | 441-1463-01 |
| -25 | 211-0507-00 | | | 2 | SCREW,MACHINE:6-32 X 0.312,PNH,STL | 83385 | ORDER BY DESCR |
| -26 | 210-0457-00 | | | 2 | NUT,PL,ASSEM WA:6-32 X 0.312,STL CD PL | 78189 | 511-061800-00 |
| -27 | 211-0008-00 | | | 2 | SCREW,MACHINE:4-40 X 0.25,PNH,STL (END ATTACHING PARTS) | 93907 | ORDER BY DESCR |
| -28 | 210-0201-00 | | | 1 | TERMINAL,LUG:0.12 ID,LOCKING,BRZ TIN PL (ATTACHING PARTS) | 86928 | A373-157-2 |
| -29 | 211-0008-00 | | | 1 | SCREW,MACHINE:4-40 X 0.25,PNH,STL | 93907 | ORDER BY DESCR |
| -30 | 210-0586-00 | | | 1 | NUT,PL,ASSEM WA:4-40 X 0.25,STL CD PL (END ATTACHING PARTS) | 78189 | 211-041800-00 |
| -31 | 210-0202-00 | | | 1 | TERMINAL,LUG:0.146 ID,LOCKING,BRZ TIN PL (ATTACHING PARTS) | 86928 | A-373-158-2 |
| -32 | 211-0504-00 | | | 1 | SCREW,MACHINE:6-32 X 0.250,PNH,STL (END ATTACHING PARTS) | TK0435 | ORDER BY DESCR |
| -33 | ----- | | | 1 | RES:(SEE R83 REPL) (ATTACHING PARTS) | | |
| -34 | 211-0504-00 | | | 2 | SCREW,MACHINE:6-32 X 0.250,PNH,STL (END ATTACHING PARTS) | TK0435 | ORDER BY DESCR |
| | 672-1176-00 | | | 1 | CIRCUIT BD ASSY:VERT AMPL W/FLEX CONN CKT. BOARD ASSY. INCLUDES: | 80009 | 672-1176-00 |
| -35 | ----- | | | 1 | .CIRCUIT BOARD ASSY:VERT AMPL(SEE A18 REPL) (ATTACHING PARTS) | | |
| -36 | 211-0008-00 | | | 4 | .SCREW,MACHINE:4-40 X 0.25,PNH,STL (END ATTACHING PARTS) | 93907 | ORDER BY DESCR |
| | | | | | .VERT AMPLIFIER BOARD INCLUDES: | | |
| -37 | 136-0252-00 | | | 2 | ..SOCKET,PIN TERM:U/W 0.018 DIA PINS | 00779 | 2-330808-7 |
| -38 | 136-0252-07 | | | 3 | ..SOCKET,PIN CONN:W/O DIMPLE | 22526 | 75060-012 |
| -39 | ----- | | | 1 | ..TRANSISTOR:(SEE Q720 REPL) (ATTACHING PARTS) | | |
| -40 | 211-0097-00 | | | 1 | ..SCREW,MACHINE:4-40 X 0.312,PNH,STL | 93907 | ORDER BY DESCR |
| -41 | 210-0407-00 | | | 1 | ..NUT,PLAIN,HEX:6-32 X 0.25,BRS CD PL | 73743 | 3038-402 |
| -42 | 210-0551-00 | | | 1 | ..NUT,PLAIN,HEX:4-40 X 0.25,ST CD PL | TK0435 | ORDER BY DESCR |

Replaceable Mechanical Parts - 7904A

| Fig. & Index No. | Tektronix Part No. | Serial/Assembly No. Effective | Discnt | Qty | 12345 Name & Description | Mfr. Code | Mfr. Part No. |
|------------------|--------------------|-------------------------------|---------|-----|--|-----------|----------------|
| 3- | | | | | ..(END ATTACHING PARTS) | | |
| -43 | 214-2543-00 | | | 1 | ..HT SK,MICROCKT:MICROCIRCUIT,AL | 80009 | 214-2543-00 |
| | 131-1967-00 | | | 2 | ..CONT SET,ELEC:MICROCKT,1.75 CM,RUBBER | 80009 | 131-1967-00 |
| -44 | 426-1351-00 | | | 2 | ..FRAME,MICROCKT:1.75 CM | 80009 | 426-1351-00 |
| | | | | | ..(ATTACHING PARTS) | | |
| -45 | 211-0259-00 | | | 6 | ..SCR,ASSEM WSHR:2-56 X 0.437,PNH,STL,POZ | 01536 | 4821-00021 |
| | | | | | ..(END ATTACHING PARTS) | | |
| -46 | 211-0260-00 | | | 2 | ..SCR,ASSEM WSHR:2-56 X 0.687,PNH,STL,POZ | 01536 | ORDER BY DESCR |
| -47 | ----- | | | 1 | CKT BOARD ASSY:HORIZ AMPL(SEE A28 REPL) | | |
| | | | | | (ATTACHING PARTS) | | |
| -48 | 211-0008-00 | | | 3 | ..SCREW,MACHINE:4-40 X 0.25,PNH,STL | 93907 | ORDER BY DESCR |
| | | | | | (END ATTACHING PARTS) | | |
| | | | | | HORIZ AMPLIFIER BOARD INCLUDES: | | |
| -49 | 136-0252-07 | | | 51 | ..SDCKET,PIN CONN:W/O DIMPLE | 22526 | 75060-012 |
| -50 | 214-0973-00 | | | 2 | ..HEAT SINK,XSTR:TO-92,CU BE CD PL | 80009 | 214-0973-00 |
| -51 | 195-0093-01 | 8010100 | B041935 | 2 | ..LEAD,ELECTRICAL:26 AWG,2.0 L,9-7 | 80009 | 195-0093-01 |
| | 195-0093-02 | 8041936 | | 2 | ..LEAD,ELECTRICAL:26 AWG,2.0 L,9-7 | 80009 | 195-0093-02 |
| | | | | | ..(TO CRT) | | |
| | 131-1538-00 | 8010100 | B041935 | 1 | ..CONNECTOR,TERM:22-26 AWG U/O 0.04 SQ PIN | 22526 | 75369-002 |
| | 131-2525-00 | 8041936 | | 1 | ..CONN,PLUG,ELEC:CRT,22-26 AWG | 06776 | PS40-101 |
| -52 | 441-1465-00 | | | 1 | CHASSIS,SCOPE:HORIZONTAL AMPLIFIER | 80009 | 441-1465-00 |
| | | | | | (ATTACHING PARTS) | | |
| -53 | 210-0457-00 | | | 2 | NUT,PL,ASSEM WA:6-32 X 0.312,STL CD PL | 78189 | 511-061800-00 |
| | | | | | (END ATTACHING PARTS) | | |
| -54 | 136-0745-00 | | | 1 | SKT,PL-IN ELEK:CRT,10 PIN W/LEADS | 80009 | 136-0745-00 |
| -55 | 352-0205-00 | | | 1 | ..HLDR,TERM CONN:9 WIRE,BLACK | 80009 | 352-0205-00 |
| -56 | 352-0163-06 | | | 1 | ..HLDR,TERM CONN:5 WIRE,BLUE | 80009 | 352-0163-06 |
| -57 | 131-0707-00 | | | 5 | ..CONTACT,ELEC:22-26 AWG,BRS,CU BE GLD PL | 22526 | 47439-000 |
| -58 | 131-0621-00 | | | 5 | ..CONN,TERM:22-26 AWG,BRS,CU BE GLD PL | 22526 | 46231-000 |
| -59 | 136-0304-03 | | | 1 | ..SKT,PL-IN ELEK:ELECTRON TUBE,14 CONTACT | 80009 | 136-0304-03 |
| -60 | 200-0917-01 | | | 1 | ..COVER,CRT SKT:2.052 OD X 0.291 H,PLASTIC | 80009 | 200-0917-01 |
| -61 | 367-0117-00 | | | 1 | ..PULL,SOCKET:CRT,PLASTIC | 80009 | 367-0117-00 |
| -62 | 343-0254-00 | | | 1 | ..CLP,ELCTRN TUBE:DELTRIN | 80009 | 343-0254-00 |
| -63 | 380-0563-01 | | | 1 | HSG,HV PWR SPLY:ALUMINUM | 80009 | 380-0563-01 |
| | | | | | (ATTACHING PARTS) | | |
| -64 | 211-0507-00 | | | 4 | SCREW,MACHINE:6-32 X 0.312,PNH,STL | 83385 | ORDER BY DESCR |
| -65 | 210-0457-00 | | | 4 | NUT,PL,ASSEM WA:6-32 X 0.312,STL CD PL | 78189 | 511-061800-00 |
| | | | | | (END ATTACHING PARTS) | | |
| -66 | 348-0233-00 | | | 2 | GROMMET,PLASTIC:GRAY,OBLONG 0.847 X 0.347 | 80009 | 348-0233-00 |
| -67 | 348-0063-00 | | | 1 | GROMMET,PLASTIC:GRAY,ROUND,0.0457 ID | 80009 | 348-0063-00 |
| -68 | 129-0203-00 | | | 1 | SPACER,POST:1.141 L,4-40 EA END,BRASS | 80009 | 129-0203-00 |
| | | | | | (ATTACHING PARTS) | | |
| -69 | 211-0008-00 | | | 1 | SCREW,MACHINE:4-40 X 0.25,PNH,STL | 93907 | ORDER BY DESCR |
| | | | | | (END ATTACHING PARTS) | | |
| -70 | 220-0547-01 | | | 3 | NUT BLOCK:4-40 X 0.282,NI SIL NP | 80009 | 220-0547-01 |
| | | | | | (ATTACHING PARTS) | | |
| -71 | 211-0105-00 | | | 1 | SCREW,MACHINE:4-40 X 0.188,FLH,100 DEG | TK0435 | ORDER BY DESCR |
| -72 | 211-0007-00 | | | 2 | SCREW,MACHINE:4-40 X 0.188,PNH,STL | 93907 | ORDER BY DESCR |
| | | | | | (END ATTACHING PARTS) | | |
| -73 | 343-0089-00 | | | 1 | CLAMP,CABLE:0.3 DIA,PLASTIC | 80009 | 343-0089-00 |
| -74 | ----- | | | 1 | CKT BOARD ASSY:HV(SEE A20 REPL) | | |
| | | | | | (ATTACHING PARTS) | | |
| -75 | 211-0008-00 | | | 4 | SCREW,MACHINE:4-40 X 0.25,PNH,STL | 93907 | ORDER BY DESCR |
| | | | | | (END ATTACHING PARTS) | | |
| | | | | | HV BOARD INCLUDES: | | |
| -76 | ----- | | | 1 | ..SEMICONV DEVICE:(SEE U21 REPL) | | |
| | | | | | ..(ATTACHING PARTS) | | |
| -77 | 220-0835-00 | | | 1 | ..NUT,PLAIN,HEX:10-24,0.375 DIA,NYLON | 85480 | HNNY-1024NA |
| -78 | 210-0415-00 | 8010100 | B031889 | 1 | ..NUT,PLAIN,HEX:10-24 X 0.375,STL NP | 73743 | ORDER BY DESCR |
| | 220-0835-00 | 8031890 | | 1 | ..NUT,PLAIN,HEX:10-24,0.375 DIA,NYLON | 85480 | HNNY-1024NA |
| | | | | | (END ATTACHING PARTS) | | |
| -79 | ----- | | | 1 | ..TRANSFORMER:(SEE T14 REPL) | | |
| | | | | | ..(ATTACHING PARTS) | | |
| -80 | 211-0008-00 | | | 4 | ..SCREW,MACHINE:4-40 X 0.25,PNH,STL | 93907 | ORDER BY DESCR |
| | | | | | ..(END ATTACHING PARTS) | | |
| -81 | 129-0072-00 | | | 1 | ..INSULATOR,STDF:0.938 L X 0.188 | 80009 | 129-0072-00 |
| -82 | 361-0007-00 | | | 1 | ..SPACER,SLEEVE:0.188 L X 0.111 ID,POLTHN | 80009 | 361-0007-00 |
| -83 | 136-0252-07 | | | 3 | ..SOCKET,PIN CONN:W/O DIMPLE | 22526 | 75060-012 |

| Fig. & Index No. | Tektronix Part No. | Serial/Assembly No. Effective | Dscont | Qty | 12345 Name & Description | Mfr. Code | Mfr. Part No. |
|------------------|--------------------|-------------------------------|---------|-----|---|-----------|----------------|
| 3-84 | 136-0729-00 | | | 1 | .SKT,PL-IN ELEK:MICROCKT,16 CONTACT | 09922 | DILB16P-108T |
| -85 | 200-2289-00 | | | 1 | COV,HV PWR SPLY:ALUMINUM (ATTACHING PARTS) | 80009 | 200-2289-00 |
| -86 | 211-0008-00 | | | 3 | SCREW,MACHINE:4-40 X 0.25,PNH,STL (END ATTACHING PARTS) | 93907 | ORDER BY DESCR |
| -87 | ----- | | | 1 | DELAY LINE:(SEE A24 REPL) (ATTACHING PARTS) | | |
| -88 | 211-0507-00 | | | 2 | SCREW,MACHINE:6-32 X 0.312,PNH,STL (END ATTACHING PARTS) | 83385 | ORDER BY DESCR |
| -89 | 386-4064-01 | | | 1 | SUPPORT,CHASSIS:MAIN (ATTACHING PARTS) | 80009 | 386-4064-01 |
| -90 | 211-0507-00 | | | 2 | SCREW,MACHINE:6-32 X 0.312,PNH,STL | 83385 | ORDER BY DESCR |
| | 210-0457-00 | | | 2 | NUT,PL,ASSEM WA:6-32 X 0.312,STL CD PL (END ATTACHING PARTS) | 78189 | 511-061800-00 |
| -91 | 369-0035-00 | | | 1 | IMPLR,FAN,AXIAL:3.5DIA BL,CCW,0.080ID,PLSTC SAFETY CONTROLLED | 52792 | 3500-CCW .080N |
| -92 | 407-1874-01 | | | 1 | BRACKET,ANGLE:FAN (ATTACHING PARTS) | 80009 | 407-1874-01 |
| -93 | 211-0504-00 | | | 1 | SCREW,MACHINE:6-32 X 0.250,PNH,STL (END ATTACHING PARTS) | TK0435 | ORDER BY DESCR |
| -94 | 343-0411-00 | | | 2 | STRAP,RETAINING:2.494 X 0.8,STL TIN PL (ATTACHING PARTS) | 80009 | 343-0411-00 |
| -95 | 211-0510-00 | | | 2 | SCREW,MACHINE:6-32 X 0.375,PNH,STL | 83385 | ORDER BY DESCR |
| -96 | 210-0457-00 | | | 2 | NUT,PL,ASSEM WA:6-32 X 0.312,STL CD PL (END ATTACHING PARTS) | 78189 | 511-061800-00 |
| -97 | ----- | | | 1 | CKT BOARD ASSY:(SEE A11 REPL) (ATTACHING PARTS) | | |
| -98 | 211-0504-00 | | | 1 | SCREW,MACHINE:6-32 X 0.250,PNH,STL (END ATTACHING PARTS) FAN BOARD INCLUDES: | TK0435 | ORDER BY DESCR |
| -99 | 136-0252-07 | | | 3 | .SOCKET,PIN CONN:W/O DIMPLE | 22526 | 75060-012 |
| -100 | 136-0728-00 | | | 1 | .SKT,PL-IN ELEK:MICROCKT,14 CONTACT | 09922 | DILB14P-108 |
| -101 | 343-0013-00 | B010100 | B010114 | 1 | CLAMP,LOOP:0.375 ID,PLASTIC | 06915 | ORDER BY DESCR |
| | 343-0006-00 | B010115 | | 1 | CLAMP,LOOP:0.5 ID,PLASTIC (ATTACHING PARTS) | 06915 | ORDER BY DESCR |
| -102 | 212-0010-00 | | | 1 | SCREW,MACHINE:8-32 X 0.625,PNH,STL | 83385 | ORDER BY DESCR |
| -103 | 210-0458-00 | | | 1 | NUT,PL,ASSEM WA:8-32 X 0.344,STL CD PL | 78189 | 511-081800-00 |
| -104 | 210-0863-00 | | | 1 | WSHR,LOOP CLAMP:0.091 ID U/W 0.5 W CLP,STL (END ATTACHING PARTS) | 95987 | C191 |
| -105 | ----- | | | 1 | CKT BOARD ASSY:HORIZ INTERCON(SEE A19 REPL) | | |
| -106 | 211-0155-00 | | | 2 | .SCREW,EXT RLV:4-40 X 0.375,PNH,SST,POZ | 80009 | 211-0155-00 |
| -107 | 361-0301-00 | | | 2 | .SPACER,POST:0.198 L W/4-40 THD ONE END | 80009 | 361-0301-00 |
| -108 | 136-0263-07 | | | 12 | .SOCKET,PIN TERM:U/W 0.025 SQ PIN | 22526 | ORDER BY DESCR |
| -109 | ----- | | | 1 | CKT BOARD ASSY:HORIZ INTFC(SEE A29 REPL) (ATTACHING PARTS) | | |
| -110 | 211-0008-00 | | | 4 | SCREW,MACHINE:4-40 X 0.25,PNH,STL (END ATTACHING PARTS) HORIZ INTERFACE BOARD INCLUDES: | 93907 | ORDER BY DESCR |
| -111 | 129-0561-00 | | | 2 | .SPACER,POST:0.535 L,4-40 INT ONE END,BRS, .0.219 OD | 80009 | 129-0561-00 |
| -112 | 136-0252-07 | | | 11 | .SOCKET,PIN CONN:W/O DIMPLE | 22526 | 75060-012 |
| -113 | 131-0591-00 | | | 15 | .TERMINAL,PIN:0.835 L X 0.025 SQ PH BRZ | 22526 | 47332 |
| | 131-0608-00 | | | 81 | .TERMINAL,PIN:0.365 L X 0.025 BRZ GLD PL | 22526 | 48283-036 |
| -114 | 386-5055-00 | | | 1 | SUPPORT,CHASSIS:MAIN | 80009 | 386-5055-00 |
| -115 | 351-0581-00 | | | 1 | GUIDE,FLIPSTAND:ALUMINUM (ATTACHING PARTS) | 80009 | 351-0581-00 |
| -116 | 211-0507-00 | | | 2 | SCREW,MACHINE:6-32 X 0.312,PNH,STL (END ATTACHING PARTS) | 83385 | ORDER BY DESCR |
| -117 | ----- | | | 1 | CKT BOARD ASSY:Z AXIS(SEE A21 REPL) (ATTACHING PARTS) | | |
| -118 | 211-0008-00 | | | 4 | SCREW,MACHINE:4-40 X 0.25,PNH,STL (END ATTACHING PARTS) Z AXIS BOARD INCLUDES: | 93907 | ORDER BY DESCR |
| -119 | 136-0252-07 | | | 3 | .SOCKET,PIN CONN:W/O DIMPLE | 22526 | 75060-012 |
| -120 | 131-0608-00 | B010100 | B021636 | 34 | .TERMINAL,PIN:0.365 L X 0.025 BRZ GLD PL | 22526 | 48283-036 |
| | 131-0608-00 | B021637 | | 2 | .TERMINAL,PIN:0.365 L X 0.025 BRZ GLD PL | 22526 | 48283-036 |
| | 131-0589-00 | B010100 | B021636 | 2 | .TERMINAL,PIN:0.46 L X 0.025 SQ PH BRZ | 22526 | 48283-029 |
| | 131-0993-00 | B010230 | | 1 | .BUS,CONDUCTOR:SHUNT ASSEMBLY,BLACK | 22526 | 65474-005 |

Replaceable Mechanical Parts - 7904A

| Fig. & Index No. | Tektronix Part No. | Serial/Assembly No. Effective Dscont | Qty | 12345 Name & Description | Mfr. Code | Mfr. Part No. |
|------------------|--------------------|--------------------------------------|-----|--|-----------|---------------|
| 3-121 | 129-0669-00 | | 1 | .SPACER,POST:2.03 L,6-32 THD BOTH ENDS AL,0.25 DIA | 80009 | 129-0669-00 |
| | | | | A29 HORIZONTAL INTFC WIRE KITS | | |
| | 175-4758-00 | | 1 | CA ASSY,SP,ELEC:2,26 AWG,6.0 L,RIBBON (A29P044 TO A2P2004) | 80009 | 175-4758-00 |
| | 131-0707-00 | | 4 | .CONTACT,ELEC:22-26 AWG,BRS,CU BE GLD PL | 22526 | 47439-000 |
| | 352-0169-00 | | 2 | .HLDR,TERM CONN:2 WIRE,BLACK | 80009 | 352-0169-00 |
| | 175-0825-00 | | AR | .CABLE,SP,ELEC:2,26 AWG,STRD,PVC JKT,RBN (.0.521 FT) | 80009 | 175-0825-00 |
| | 175-2364-01 | | 1 | CA ASSY,SP,ELEC:9,26 AWG,6.0 L,RIBBON (A29P06 TO A2P2006) | 80009 | 175-2364-01 |
| | 131-0707-00 | | 18 | .CONTACT,ELEC:22-26 AWG,BRS,CU BE GLD PL | 22526 | 47439-000 |
| | 352-0167-00 | | 2 | .HLDR,TERM CONN:9 WIRE,BLACK | 80009 | 352-0167-00 |
| | 175-0832-00 | | AR | .CABLE,SP,ELEC:9,26 AWG,STRD,PVC JKT,RBN (.0.521 FT) | 08261 | 111-2699-956 |
| | 175-8248-00 | | 1 | CA ASSY,SP,ELEC:8,26 AWG,7.0 L,RIBBON (A29P904 TO A1P1904) | 80009 | 175-8248-00 |
| | 131-0707-00 | | 12 | .CONTACT,ELEC:22-26 AWG,BRS,CU BE GLD PL | 22526 | 47439-000 |
| | 352-0164-00 | | 2 | .HLDR,TERM CONN:6 WIRE,BLACK | 80009 | 352-0164-00 |
| | 175-0829-00 | | AR | .CABLE,SP,ELEC:6,26 AWG,STRD,PVC JKT,RBN (.0.604 FT) | 08261 | 111-2699-973 |
| | 175-8251-00 | | 1 | CA ASSY,SP,ELEC:2,26 AWG,18.0 L,RIBBON (A29P80 TO A28P59) | 80009 | 175-8251-00 |
| | 131-0707-00 | | 4 | .CONTACT,ELEC:22-26 AWG,BRS,CU BE GLD PL | 22526 | 47439-000 |
| | 352-0169-00 | | 2 | .HLDR,TERM CONN:2 WIRE,BLACK | 80009 | 352-0169-00 |
| | 175-0825-00 | | AR | .CABLE,SP,ELEC:2,26 AWG,STRD,PVC JKT,RBN (.1.521 FT) | 80009 | 175-0825-00 |
| | 175-8250-00 | | 1 | CA ASSY,SP,ELEC:7,26 AWG,19.0 L,RIBBON (A29P74 TO A18P207) | 80009 | 175-8250-00 |
| | 131-0707-00 | | 14 | .CONTACT,ELEC:22-26 AWG,BRS,CU BE GLD PL | 22526 | 47439-000 |
| | 352-0165-00 | | 2 | .HLDR,TERM CONN:7 WIRE,BLACK | 80009 | 352-0165-00 |
| | 175-0830-00 | | AR | .CABLE,SP,ELEC:7,26 AWG,STRD,PVC JKT,RBN (.1.604 FT) | 08261 | 111-2699-972 |
| | 175-2854-00 | | 1 | CA ASSY,SP,ELEC:2,26 AWG,5.0 L,RIBBON (A29P80 TO A11P80) | 80009 | 175-2854-00 |
| | 131-0707-00 | | 4 | .CONTACT,ELEC:22-26 AWG,BRS,CU BE GLD PL | 22526 | 47439-000 |
| | 352-0169-00 | | 2 | .HLDR,TERM CONN:2 WIRE,BLACK | 80009 | 352-0169-00 |
| | 175-0825-00 | | AR | .CABLE,SP,ELEC:2,26 AWG,STRD,PVC JKT,RBN (.0.438 FT) | 80009 | 175-0825-00 |
| | 175-2552-00 | | 1 | CA ASSY,SP,ELEC:8,26 AWG,15.0 L,RIBBON (A29P95 TO A28P95) | 80009 | 175-2552-00 |
| | 131-0707-00 | | 16 | .CONTACT,ELEC:22-26 AWG,BRS,CU BE GLD PL | 22526 | 47439-000 |
| | 352-0166-00 | | 2 | .HLDR,TERM CONN:8 WIRE,BLACK | 80009 | 352-0166-00 |
| | 175-0831-00 | | AR | .CABLE,SP,ELEC:8,26 AWG,STRD,PVC INSUL,RBN (.1.271 FT) | 08261 | 111-2699-971 |
| | 175-2755-00 | | 1 | CA ASSY,SP,ELEC:10,26 AWG,5.0 L (A29P132 TO A21P132) | 80009 | 175-2755-00 |
| | 131-0707-00 | | 20 | .CONTACT,ELEC:22-26 AWG,BRS,CU BE GLD PL | 22526 | 47439-000 |
| | 352-0168-00 | | 2 | .HLDR,TERM CONN:10 WIRE,BLACK | 80009 | 352-0168-00 |
| | 175-0833-00 | | AR | .CABLE,SP,ELEC:10,26 AWG STRD,PVC JKT,RBN (.0.438 FT) | 08261 | 111-2699-970 |
| | 175-8249-00 | | 1 | CA ASSY,SP,ELEC:7,26 AWG,4.0 L,RIBBON (A29P57 TO A21P57) | 80009 | 175-8249-00 |
| | 131-0707-00 | | 14 | .CONTACT,ELEC:22-26 AWG,BRS,CU BE GLD PL | 22526 | 47439-000 |
| | 352-0165-00 | | 2 | .HLDR,TERM CONN:7 WIRE,BLACK | 80009 | 352-0165-00 |
| | 175-0830-00 | | AR | .CABLE,SP,ELEC:7,26 AWG,STRD,PVC JKT,RBN (.0.354 FT) | 08261 | 111-2699-972 |

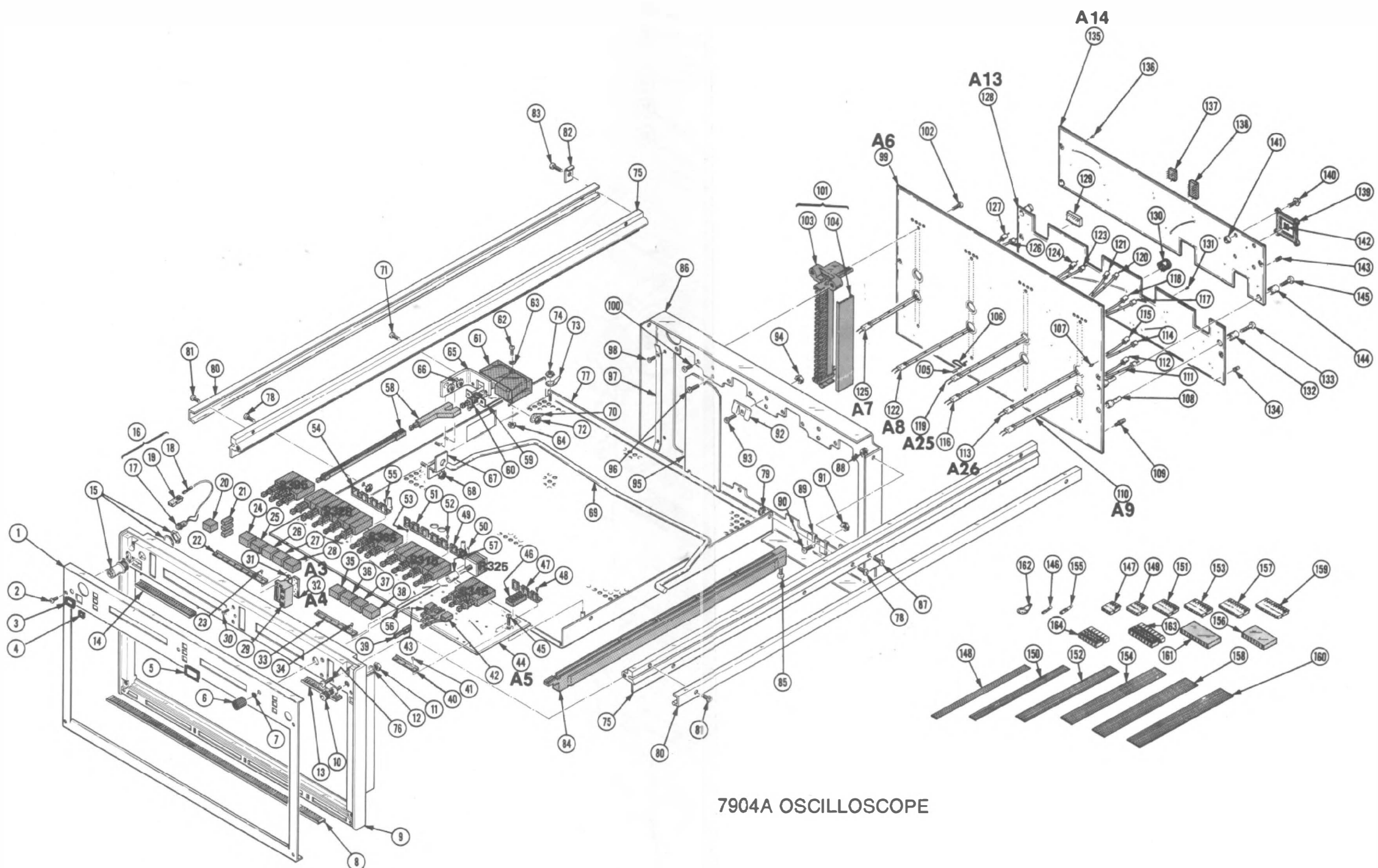

7904A OSCILLOSCOPE

| Fig. & Index No. | Tektronix Part No. | Serial/Assembly No. | | Qty | 12345 Name & Description | Mfr. Code | Mfr. Part No. | |
|------------------|--------------------|---------------------|--------|-----|---|-----------|------------------|--|
| | | Effective | Dscont | | | | | |
| 4-1 | 333-2318-00 | | | 1 | PANEL,FRONT:LOWER (ATTACHING PARTS) | 80009 | 333-2318-00 | |
| -2 | 213-0055-00 | | | 5 | SCREW,TPG,TF:2-32 X 0.188,TYPE B,PNH,STL (END ATTACHING PARTS) | 93907 | ORDER BY DESCR | |
| -3 | 426-0681-00 | | | 1 | FRAME,PUSH BTN: | 80009 | 426-0681-00 | |
| -4 | 426-1072-00 | | | 3 | FRAME,PUSH BTN:SILVER GRAY PLSTC | 80009 | 426-1072-00 | |
| -5 | 426-0568-00 | | | 9 | FRAME,PUSH BTN: | 80009 | 426-0568-00 | |
| -6 | 366-1023-01 | | | 1 | KNOB:GY,0.127 ID X 0.392 OD X 0.531 H | 80009 | 366-1023-01 | |
| -7 | 358-0599-00 | | | 1 | BUSHING,SLEEVE:0.125 ID X 0.25 OD X 0.234 | 28520 | B-187-125 | |
| -8 | 348-0204-00 | | | 1 | SHLD GSKT,ELEK:FINGER TYPE,10.65 L | 80009 | 348-0204-00 | |
| -9 | 426-0806-03 | | | 1 | FRAME PNL,CAB.:LOWER FRONT | 80009 | 426-0806-03 | |
| | 348-0274-02 | | | 2 | SHLD GSKT,ELEK:FINGER TYPE,10.55 (OPTION 03 ONLY) (ATTACHING PARTS) | 80009 | 348-0274-02 | |
| -11 | 210-0583-00 | | | 1 | NUT,PLAIN,HEX:0.25-32 X 0.312,BRS CD PL | 73743 | 2X-20319-402 | |
| -12 | 210-0046-00 | | | 1 | WASHER,LOCK:0.261 ID,INTL,0.018 THK,STL (END ATTACHING PARTS) | 77900 | 1214-05-00-0541C | |
| -13 | 337-1542-00 | | | 1 | SHLD GSKT,ELEK:EMI | 80009 | 337-1542-00 | |
| -14 | 337-1543-00 | | | 3 | SHLD GSKT,ELEK:EMI | 80009 | 337-1543-00 | |
| -15 | 131-1315-01 | | | 1 | CONN,RCPT,ELEC:BNC,FEMALE (ATTACHING PARTS) | 80009 | 131-1315-01 | |
| | 210-0012-00 | B021385 | | 1 | WASHER,LOCK:0.384 ID,INTL,0.022 THK,STL | 09772 | ORDER BY DESCR | |
| | 220-0495-00 | B021385 | | 1 | NUT,PLAIN,HEX:0.375-32 X 0.438 HEX,BRS (END ATTACHING PARTS) | 73743 | ORDER BY DESCR | |
| -16 | 150-0121-07 | | | 1 | LAMP,CARTRIDGE:5V,0.06A,GREEN,4.125 L,5-N | 80009 | 150-0121-07 | |
| -17 | ----- | | | 1 | .LAMP,CARTRIDGE:(SEE DS308 REPL) | | | |
| -18 | 131-0707-00 | | | 2 | .CONTACT,ELEC:22-26 AWG,BRS,CU BE GLD PL | 22526 | 47439-000 | |
| -19 | 352-0168-08 | | | 1 | .HLDR,TERM CONN:10 WIRE,GRAY (TO ASP308) | 80009 | 352-0168-08 | |
| -20 | 366-1480-02 | | | 1 | PUSH BUTTON:BLACK,PWR OFF | 80009 | 366-1480-02 | |
| -21 | 366-1559-00 | | | 3 | PUSH BUTTON:SIL GY,0.18 SQ X 0.43 | 80009 | 366-1559-00 | |
| -22 | 343-0495-09 | | | 1 | CLIP,SWITCH:FRONT,7.5MM X 9 UNIT (ATTACHING PARTS) | 80009 | 343-0495-09 | |
| -23 | 210-3033-00 | | | 9 | EYELET,METALLIC:0.059 OD X 0.156 L,BRS (END ATTACHING PARTS) | 07707 | SE-25 | |
| -24 | 366-1161-57 | | | 1 | PUSH BUTTON:SIL GY,LEFT | 80009 | 366-1161-57 | |
| -25 | 366-1161-31 | | | 1 | PUSH BUTTON:SIL GY,ALT | 80009 | 366-1161-31 | |
| -26 | 366-1161-27 | | | 1 | PUSH BUTTON:SIL GY,ADD | 80009 | 366-1161-27 | |
| -27 | 366-1161-30 | | | 1 | PUSH BUTTON:SIL GY,CHOP | 80009 | 366-1161-30 | |
| -28 | 366-1161-58 | | | 1 | PUSH BUTTON:SIL GY,RIGHT | 80009 | 366-1161-58 | |
| -29 | 351-0509-00 | | | 2 | GUIDE,PUSH BTN:THREE LAMP (ATTACHING PARTS) | 80009 | 351-0509-00 | |
| -30 | 211-0030-00 | | | 4 | SCREW,MACHINE:2-56 X 0.25,FLH,82 DEG,STL | 93907 | ORDER BY DESCR | |
| -31 | 210-0405-00 | | | 4 | NUT,PLAIN,HEX:2-56 X 0.188,BRS CD PL (END ATTACHING PARTS) | 73743 | 12157-50 | |
| -32 | ----- | | | 2 | CKT BOARD ASSY:(SEE A3,A4 REPL) | | | |
| -33 | 343-0495-07 | | | 1 | CLIP,SWITCH:FRONT,7.5MM X 7 UNIT (ATTACHING PARTS) | 80009 | 343-0495-07 | |
| -34 | 210-3033-00 | | | 7 | EYELET,METALLIC:0.059 OD X 0.156 L,BRS (END ATTACHING PARTS) | 07707 | SE-25 | |
| -35 | 366-1161-55 | | | 1 | PUSH BUTTON:SIL GY,A | 80009 | 366-1161-55 | |
| -36 | 366-1161-31 | | | 1 | PUSH BUTTON:SIL GY,ALT | 80009 | 366-1161-31 | |
| -37 | 366-1161-30 | | | 1 | PUSH BUTTON:SIL GY,CHOP | 80009 | 366-1161-30 | |
| -38 | 366-1161-56 | | | 1 | PUSH BUTTON:SIL GY,B | 80009 | 366-1161-56 | |
| -39 | 366-1650-00 | | | 6 | PUSH BUTTON:CLEAR,0.184 X 0.214 X 8.0 | 80009 | 366-1650-00 | |
| -40 | 343-0496-03 | | | 3 | CLIP,SWITCH:FRONT,10MM X 3 UNIT (ATTACHING PARTS) | 80009 | 343-0496-03 | |
| -41 | 210-3033-00 | | | 18 | EYELET,METALLIC:0.059 OD X 0.156 L,BRS (END ATTACHING PARTS) | 07707 | SE-25 | |
| -42 | 384-1354-00 | | | 6 | EXTENSION SHAFT:1.585 L,OFFSET,NYLON | 80009 | 384-1354-00 | |
| -43 | 384-1136-00 | | | 3 | EXTENSION SHAFT:0.95 INCH LONG | 80009 | 384-1136-00 | |
| -44 | ----- | | | 1 | CKT BOARD ASSY:MODE SWITCH(SEE A5 REPL) (ATTACHING PARTS) | | | |
| -45 | 211-0008-00 | | | 5 | SCREW,MACHINE:4-40 X 0.25,PNH,STL (END ATTACHING PARTS) MODE SWITCH BOARD INCLUDES: | 93907 | ORDER BY DESCR | |
| -46 | 136-0269-02 | | | 5 | .SKT,PL-IN ELEK:MICROCIRCUIT,14 DIP | 09922 | DILB14P-108T | |
| -47 | 343-0497-03 | | | 3 | .CLIP,SWITCH:REAR,10MM X 3 UNIT | 80009 | 343-0497-03 | |

| Fig. & Index No. | Tektronix Part No. | Serial/Assembly No. Effective Discnt | Qty | 12345 Name & Description | Mfr. Code | Mfr. Part No. |
|------------------|--------------------|--------------------------------------|-----|---|-----------|----------------|
| 4-84 | 351-0181-06 | | 4 | GUIDE,SLIDE:PLUG-IN UNIT,LWR,SFTY CNTRLD (ATTACHING PARTS) | 80009 | 351-0181-06 |
| -85 | 213-0146-00 | | 4 | SCREW,TPG,TF:6-20 X 0.312,TYPE B,PNH,STL (END ATTACHING PARTS) | 83385 | ORDER BY DESCR |
| -86 | 426-1487-00 | | 1 | FRAME,PL-IN HSG:REAR (ATTACHING PARTS) | 80009 | 426-1487-00 |
| -87 | 211-0507-00 | | 2 | SCREW,MACHINE:6-32 X 0.312,PNH,STL | 83385 | ORDER BY DESCR |
| -88 | 210-0457-00 | | 2 | NUT,PL,ASSEM WA:6-32 X 0.312,STL CD PL (END ATTACHING PARTS) | 78189 | 511-061800-00 |
| -89 | 131-0930-00 | | 3 | CONTACT,ELEC:PLUG-IN GND,CU BE HEAT TRTD (ATTACHING PARTS) | 80009 | 131-0930-00 |
| -90 | 211-0008-00 | | 3 | SCREW,MACHINE:4-40 X 0.25,PNH,STL | 93907 | ORDER BY DESCR |
| -91 | 210-0586-00 | | 3 | NUT,PL,ASSEM WA:4-40 X 0.25,STL CD PL (END ATTACHING PARTS) | 78189 | 211-041800-00 |
| -92 | 131-0779-00 | | 3 | JACK,TIP:U/W 0.08 OD TEST POINT (ATTACHING PARTS) | 98291 | 0168010000208 |
| -93 | 211-0008-00 | | 3 | SCREW,MACHINE:4-40 X 0.25,PNH,STL | 93907 | ORDER BY DESCR |
| -94 | 210-0586-00 | | 3 | NUT,PL,ASSEM WA:4-40 X 0.25,STL CD PL (END ATTACHING PARTS) | 78189 | 211-041800-00 |
| -95 | 337-2514-00 | | 3 | SHIELD,ELEC:INTERFACE CIRCUIT BOARD (ATTACHING PARTS) | 80009 | 337-2514-00 |
| -96 | 211-0007-00 | | 9 | SCREW,MACHINE:4-40 X 0.188,PNH,STL (END ATTACHING PARTS) | 93907 | ORDER BY DESCR |
| -97 | 131-0800-03 | | 2 | CONTACT,ELEC:PLUG-IN GND,BE NI HT TR (ATTACHING PARTS) | 80009 | 131-0800-03 |
| -98 | 213-0138-00 | | 4 | SCREW,TPG,TF:4-24 X 0.188,TYPE B,PNH,STL (END ATTACHING PARTS) | TK0435 | ORDER BY DESCR |
| -99 | ----- | | 1 | CKT BOARD ASSY:MAIN INTERFACE(SEE A6 REPL) (ATTACHING PARTS) | | |
| -100 | 213-0119-00 | | 12 | SCREW,TPG,TF:4-24 X 0.375,TYPE B,PNH,STL (END ATTACHING PARTS) | 83385 | ORDER BY DESCR |
| -101 | ----- | | 4 | MAIN INTERFACE BOARD INCLUDES: .CONN,RCPT:CKT BD(SEE J1,J2,J3,J4 REPL) (ATTACHING PARTS) | | |
| -102 | 213-0232-00 | | 8 | .SCREW,TPG,TF:2-32 X 0.312,TYPE B,PNN,STL (END ATTACHING PARTS) | 01536 | ORDER BY DESCR |
| -103 | 204-0365-00 | | 4 | .CONNECTORS INCLUDES: .CONN BODY,RCPT:PLUG-IN CIRCUIT BOARD | 80009 | 204-0365-00 |
| -104 | 200-0950-00 | | 8 | .SHLD,ELEC CONN:PLUG-IN CKT BD,PLASTIC | 80009 | 200-0950-00 |
| -105 | 136-0619-00 | | 6 | .SOCKET,PIN TERM:U/W 0.026-0.029 DIA PINS | 00779 | 1-331677-0 |
| -106 | 214-2675-00 | | 6 | .SPRING,CKT BD: | 80009 | 214-2675-00 |
| -107 | 136-0252-07 | | 13 | .SOCKET,PIN CONN:W/O DIMPLE | 22526 | 75060-012 |
| -108 | 351-0187-00 | | 6 | .POST,CKT BD MTG:0.72 L X 0.25 OD,BRS | 80009 | 351-0187-00 |
| -109 | 386-1558-00 | | 6 | .SPACER,CKT BD:0.335 H,ACETAL | 80009 | 386-1558-00 |
| -110 | ----- | | 1 | CKT BD ASSY:HORIZ B FOLLOWER(SEE A9 REPL) | | |
| -111 | 175-8353-00 | | 1 | .CABLE ASSY,RF:50 OHM COAX,19.0 L,6-3 (A6J4 TO A29J126) | 80009 | 175-8353-00 |
| -112 | 175-8352-00 | | 1 | .CABLE ASSY,RF:50 OHM COAX,19.0 L,6-2 (A6J4 TO A29J220) | 80009 | 175-8352-00 |
| -113 | ----- | | AR | CKT BD ASSY:TRIG B FOLLOWER(SEE A26 REPL) | | |
| -114 | 175-8356-00 | | 1 | .CABLE ASSY,RF:50 OHM COAX,4.5 L,6-3 (A6J4 TO A14J473) | 80009 | 175-8356-00 |
| -115 | 175-8355-00 | | 1 | .CABLE ASSY,RF:50 OHM COAX,4.5 L,6-2 (A6J4 TO A14J472) | 80009 | 175-8355-00 |
| -116 | ----- | | 1 | CKT BD ASSY:HORIZ A FOLLOWER(SEE A10 REPL) | | |
| -117 | 175-8350-00 | | 1 | .CABLE ASSY,RF:50 OHM COAX,19.0 L,6-0 (A6J3 TO A29J226) | 80009 | 175-8350-00 |
| -118 | 175-8351-00 | | 1 | .CABLE ASSY,RF:50 OHM COAX,19.0 L,6-1 (A6J3 TO A29J320) | 80009 | 175-8351-00 |
| -119 | ----- | | 1 | CKT BD ASSY:TRIG A FOLLOWER(SEE A25 REPL) | | |
| -120 | 175-8485-00 | | 1 | .CABLE ASSY,RF:50 OHM COAX,10.0 L,6-0 (A6J3 TO A14J270) | 80009 | 175-8485-00 |
| -121 | 175-8354-00 | | 1 | .CABLE ASSY,RF:50 OHM COAX,10.0 L,6-1 (A6J3 TO A14J271) | 80009 | 175-8354-00 |
| -122 | ----- | | 1 | CKT BD ASSY:VERT CH FOLLOWER(SEE A8 REPL) | | |
| -123 | 175-8357-00 | | 1 | .CABLE ASSY,RF:50 OHM COAX,7.0 L,6-0 (A6J2 TO A14J200) | 80009 | 175-8357-00 |
| -124 | 175-8358-00 | | 1 | .CABLE ASSY,RF:50 OHM COAX,7.0 L,6-1 | 80009 | 175-8358-00 |

Replaceable Mechanical Parts - 7904A

| Fig. & Index No. | Tektronix Part No. | Serial/Assembly No. Effective | Discont | Qty | 12345 Name & Description | Mfr. Code | Mfr. Part No. |
|------------------|--------------------|-------------------------------|---------|-----|---|-----------|----------------|
| 4- | 175-8359-00 | | | 1 | .(A6J2 TO A14J201) .CABLE ASSY,RF:50 OHM COAX,9.0 L,6-2 | 80009 | 175-8359-00 |
| | 175-8360-00 | | | 1 | .(A6J2 TO A16J502) .CABLE ASSY,RF:50 OHM COAX,9.0 L,6-3 | 80009 | 175-8360-00 |
| -125 | ----- | | | 1 | .(A6J2 TO A16J503) CKT BD ASSY:VERT CH FOLLOWER(SEE A7 REPL) | | |
| -126 | 175-8357-00 | | | 1 | .CABLE ASSY,RF:50 OHM COAX,7.0 L,6-0 .(A6J1 TO A14J400) | 80009 | 175-8357-00 |
| -127 | 175-8358-00 | | | 1 | .CABLE ASSY,RF:50 OHM COAX,7.0 L,6-1 .(A6J1 TO A14J401) | 80009 | 175-8358-00 |
| | 175-8359-00 | | | 1 | .CABLE ASSY,RF:50 OHM COAX,9.0 L,6-2 .(A6J1 TO A16J602) | 80009 | 175-8359-00 |
| | 175-8360-00 | | | 1 | .CABLE ASSY,RF:50 OHM COAX,9.0 L,6-3 .(A6J1 TO A16J603) | 80009 | 175-8360-00 |
| -128 | ----- | | | 1 | CKT BOARD ASSY:LOGIC(SEE A13 REPL) | | |
| -129 | 136-0729-00 | | | 3 | .SKT,PL-IN ELEK:MICROCKT,16 CONTACT | 09922 | DILB16P-108T |
| -130 | 136-0241-00 | | | 4 | .SKT,PL-IN ELEK:MICROCIRCUIT,10 CONT,PCB MT | 71785 | 133-99-12-064 |
| -131 | 136-0252-07 | | | 4 | .SOCKET,PIN CONN:W/O DIMPLE | 22526 | 75060-012 |
| -132 | 361-0238-00 | | | 3 | .SPACER,POST:0.433 L,0.25 OD | 80009 | 361-0238-00 |
| -133 | 211-0155-00 | | | 3 | .SCREW,EXT RLV:4-40 X 0.375,PNH,SST,POZ | 80009 | 211-0155-00 |
| -134 | 136-0263-07 | | | 40 | .SOCKET,PIN TERM:U/W 0.025 SQ PIN | 22526 | ORDER BY DESCR |
| -135 | ----- | | | 1 | CKT BOARD ASSY:TRIG SELECTOR(SEE A14 REPL) | | |
| -136 | 136-0252-07 | | | 15 | .SOCKET,PIN CONN:W/O DIMPLE | 22526 | 75060-012 |
| -137 | 136-0514-00 | | | 2 | .SKT,PL-IN ELEK:MICROCIRCUIT,8 DIP | 09922 | DILB8P-108 |
| -138 | 136-0269-02 | | | 1 | .SKT,PL-IN ELEK:MICROCIRCUIT,14 DIP | 09922 | DILB14P-108T |
| -139 | 426-1352-00 | | | 5 | .FRAME,MICROCKT:1.75 CM,STEPPED .(ATTACHING PARTS) | 80009 | 426-1352-00 |
| -140 | 211-0259-00 | | | 20 | .SCR,ASSEM WSHR:2-56 X 0.437,PNH,STL,POZ | 01536 | 4821-00021 |
| -141 | 220-0797-00 | | | 20 | .NUT,CAPTIVE:2-56 X 0.218 DIA,STL CD PL .(END ATTACHING PARTS) | 46384 | CKF2-256 |
| -142 | 131-1968-00 | | | 3 | .CONT SET,ELEC:MICROCKT,1.75 CM,RUBBER | 80009 | 131-1968-00 |
| | 131-1968-01 | | | 2 | .CONT SET,ELEC:MICROCKT,1.75 CM,RUBBER | 80009 | 131-1968-01 |
| -143 | 136-0263-07 | | | 7 | .SOCKET,PIN TERM:U/W 0.025 SQ PIN | 22526 | ORDER BY DESCR |
| -144 | 361-0238-00 | | | 3 | .SPACER,POST:0.433 L,0.25 OD | 80009 | 361-0238-00 |
| -145 | 211-0155-00 | | | 3 | .SCREW,EXT RLV:4-40 X 0.375,PNH,SST,POZ | 80009 | 211-0155-00 |
| WIRE KITS | | | | | | | |
| | 198-3762-00 | | | 1 | WIRE SET,ELEC: | 80009 | 198-3762-00 |
| | 175-2855-00 | | | 1 | .CA ASSY,SP,ELEC:4,26 AWG,11.0 L,RIBBON .(A5P310 TO A1P1910) | 80009 | 175-2855-00 |
| -146 | 131-0707-00 | | | 8 | .CONTACT,ELEC:22-26 AWG,BRS,CU BE GLD PL | 22526 | 47439-000 |
| -147 | 352-0162-00 | | | 2 | .HLDR,TERM CONN:4 WIRE,BLACK | 80009 | 352-0162-00 |
| -148 | 175-0827-00 | | | AR | .CABLE,SP,ELEC:4,26 AWG,STRD,PVC JKT,RBN ..(0.938 FT) | 08261 | 111-2699-954 |
| | 175-6194-00 | | | 1 | .CA ASSY,SP,ELEC:5,26 AWG,4.75 L,RIBBON ..(A15P2171 TO A6P79) | 80009 | 175-6194-00 |
| | 131-0707-00 | | | 10 | .CONTACT,ELEC:22-26 AWG,BRS,CU BE GLD PL | 22526 | 47439-000 |
| -149 | 352-0163-00 | | | 2 | .HLDR,TERM CONN:5 WIRE,BLACK | 80009 | 352-0163-00 |
| -150 | 175-0828-00 | | | AR | .CABLE,SP,ELEC:5,26 AWG,STRD,PVC JKT,RBN ..(0.417 FT) | 08261 | 111-2699-955 |
| | 175-6196-00 | | | 1 | .CA ASSY,SP,ELEC:5,26 AWG,15.75 L,RIBBON .(A5P304 TO AMERA PINS AND GRAT LIGHTS) | 80009 | 175-6196-00 |
| | 131-0707-00 | | | 8 | .CONTACT,ELEC:22-26 AWG,BRS,CU BE GLD PL | 22526 | 47439-000 |
| | 352-0163-04 | | | 2 | .HLDR,TERM CONN:5 WIRE,YELLOW | 80009 | 352-0163-04 |
| | 175-0828-00 | | | AR | .CABLE,SP,ELEC:5,26 AWG,STRD,PVC JKT,RBN ..(1.355 FT) | 08261 | 111-2699-955 |
| | 175-6197-00 | | | 1 | .CA ASSY,SP,ELEC:5,26 AWG,21.0 L,RIBBON .(A15P2118 TO ASP318) | 80009 | 175-6197-00 |
| | 131-0707-00 | | | 10 | .CONTACT,ELEC:22-26 AWG,BRS,CU BE GLD PL | 22526 | 47439-000 |
| | 352-0163-08 | | | 2 | .HLDR,TERM CONN:5 WIRE,GRAY | 80009 | 352-0163-08 |
| | 175-0828-00 | | | AR | .CABLE,SP,ELEC:5,26 AWG,STRD,PVC JKT,RBN ..(1.771 FT) | 08261 | 111-2699-955 |
| | 175-6198-00 | | | 1 | .CA ASSY,SP,ELEC:5,26 AWG,23.0 L,RIBBON .(POWER SUPPLY P17 TO A1P1917) | 80009 | 175-6198-00 |
| | 131-0707-00 | | | 10 | .CONTACT,ELEC:22-26 AWG,BRS,CU BE GLD PL | 22526 | 47439-000 |
| | 352-0163-07 | | | 2 | .HLDR,TERM CONN:5 WIRE,VIOLET | 80009 | 352-0163-07 |
| | 175-0828-00 | | | AR | .CABLE,SP,ELEC:5,26 AWG,STRD,PVC JKT,RBN | 08261 | 111-2699-955 |

| Fig. & Index No. | Tektronix Part No. | Serial/Assembly No. Effective Dscont | Qty | 12345 Name & Description | Mfr. Code | Mfr. Part No. |
|------------------|--------------------|--------------------------------------|-----|---|-----------|---------------|
| 4- | 175-6199-00 | | 1 | ..(1.938 FT) ..CA ASSY, SP, ELEC:7,26 AWG,4.0 L,RIBBON ..(A6P80 TO A16P680) | 80009 | 175-6199-00 |
| | 131-0707-00 | | 14 | ..CONTACT, ELEC:22-26 AWG,BRS,CU BE GLD PL | 22526 | 47439-000 |
| -151 | 352-0165-00 | | 2 | ..HLDR, TERM CONN:7 WIRE, BLACK | 80009 | 352-0165-00 |
| -152 | 175-0830-00 | | AR | ..CABLE, SP, ELEC:7,26 AWG, STRD, PVC JKT, RBN ..(0.354 FT) | 08261 | 111-2699-972 |
| | 175-6200-00 | | 1 | ..CA ASSY, SP, ELEC:7,26 AWG,10.0 L,RIBBON ..(A5P305 TO A2P2005) | 80009 | 175-6200-00 |
| | 131-0707-00 | | 14 | ..CONTACT, ELEC:22-26 AWG,BRS,CU BE GLD PL | 22526 | 47439-000 |
| | 352-0165-05 | | 2 | ..HLDR, TERM CONN:7 WIRE, GREEN | 80009 | 352-0165-05 |
| | 175-0830-00 | | AR | ..CABLE, SP, ELEC:7,26 AWG, STRD, PVC JKT, RBN ..(0.854 FT) | 08261 | 111-2699-972 |
| | 175-6201-00 | | 1 | ..CA ASSY, SP, ELEC:7,26 AWG,21.0 L,RIBBON ..(A6P87 TO READDUT BNC'S) | 80009 | 175-6201-00 |
| | 131-0707-00 | | 7 | ..CONTACT, ELEC:22-26 AWG,BRS,CU BE GLD PL | 22526 | 47439-000 |
| | 352-0165-07 | | 1 | ..HLDR, TERM CONN:7 WIRE, VIOLET | 80009 | 352-0165-07 |
| | 175-0830-00 | | AR | ..CABLE, SP, ELEC:7,26 AWG, STRD, PVC JKT, RBN ..(1.792 FT) | 08261 | 111-2699-972 |
| | 175-6202-00 | | 1 | ..CA ASSY, SP, ELEC:8,26 AWG,5.5 L,RIBBON ..(A5P306 TO A3,A4) | 80009 | 175-6202-00 |
| | 131-0707-00 | | 16 | ..CONTACT, ELEC:22-26 AWG,BRS,CU BE GLD PL | 22526 | 47439-000 |
| | 352-0162-00 | | 2 | ..HLDR, TERM CONN:4 WIRE, BLACK | 80009 | 352-0162-00 |
| -153 | 352-0166-06 | | 1 | ..HLDR, TERM CONN:8 WIRE, BLUE | 80009 | 352-0166-06 |
| -154 | 175-0831-00 | | AR | ..CABLE, SP, ELEC:8,26 AWG, STRD, PVC INSUL, RBN ..(0.5 FT) | 08261 | 111-2699-971 |
| | 175-6203-00 | | 1 | ..CA ASSY, SP, ELEC:8,26 AWG,15.5 L,RIBBON ..(POWER SUPPLY P83 TO A6P83) | 80009 | 175-6203-00 |
| -155 | 131-1810-00 | | 16 | ..CONTACT, ELEC:WIRE TO PIN, PH BRZ GOLD PL | 00779 | 87124-1 |
| -156 | 204-0738-00 | | 2 | ..CONN BODY, PLUG:8 CONTACTS, SGL ROW, LKG CLIP | 00779 | 1-87175-7 |
| | 175-0831-00 | | AR | ..CABLE, SP, ELEC:8,26 AWG, STRD, PVC INSUL, RBN ..(1.313 FT) | 08261 | 111-2699-971 |
| | 175-6204-00 | | 1 | ..CA ASSY, SP, ELEC:9,26 AWG,10.0 L,RIBBON ..(A6P85 TO A29P85) | 80009 | 175-6204-00 |
| | 131-0707-00 | | 18 | ..CONTACT, ELEC:22-26 AWG,BRS,CU BE GLD PL | 22526 | 47439-000 |
| -157 | 352-0167-05 | | 2 | ..HLDR, TERM CONN:9 WIRE, GREEN | 80009 | 352-0167-05 |
| -158 | 175-0832-00 | | AR | ..CABLE, SP, ELEC:9,26 AWG, STRD, PVC JKT, RBN ..(0.854 FT) | 08261 | 111-2699-956 |
| | 175-6205-00 | | 1 | ..CA ASSY, SP, ELEC:10,26 AWG,11.0 L,RIBBON ..(A6P65 TO A15P2165) | 80009 | 175-6205-00 |
| | 131-0707-00 | | 20 | ..CONTACT, ELEC:22-26 AWG,BRS,CU BE GLD PL | 22526 | 47439-000 |
| -159 | 352-0168-05 | | 2 | ..HLDR, TERM CONN:10 WIRE, GREEN | 80009 | 352-0168-05 |
| -160 | 175-0833-00 | | AR | ..CABLE, SP, ELEC:10,26 AWG STRD, PVC JKT, RBN ..(0.938 FT) | 08261 | 111-2699-970 |
| | 175-6207-00 | | 1 | ..CA ASSY, SP, ELEC:10,26 AWG,12.0 L,RIBBON ..(A6P66 TO A27P2166) | 80009 | 175-6207-00 |
| | 131-0707-00 | | 20 | ..CONTACT, ELEC:22-26 AWG,BRS,CU BE GLD PL | 22526 | 47439-000 |
| | 352-0168-06 | | 2 | ..HLDR, TERM CONN:10 WIRE, BLUE | 80009 | 352-0168-06 |
| | 175-0833-00 | | AR | ..CABLE, SP, ELEC:10,26 AWG STRD, PVC JKT, RBN (1.021 FT) | 08261 | 111-2699-970 |
| | 175-6208-00 | | 1 | ..CA ASSY, SP, ELEC:10,26 AWG,14.0 L,RIBBON ..(A6P67 TO A15P2167) | 80009 | 175-6208-00 |
| | 131-0707-00 | | 20 | ..CONTACT, ELEC:22-26 AWG,BRS,CU BE GLD PL | 22526 | 47439-000 |
| | 352-0168-07 | | 2 | ..HLDR, TERM CONN:10 WIRE, VIOLET | 80009 | 352-0168-07 |
| | 175-0833-00 | | AR | ..CABLE, SP, ELEC:10,26 AWG STRD, PVC JKT, RBN ..(1.188 FT) | 08261 | 111-2699-970 |
| | 175-6206-00 | | 1 | ..CA ASSY, SP, ELEC:10,26 AWG,11.5 L,RIBBON ..(A6P89 TO A29P89) | 80009 | 175-6206-00 |
| | 131-0707-00 | | 20 | ..CONTACT, ELEC:22-26 AWG,BRS,CU BE GLD PL | 22526 | 47439-000 |
| | 352-0168-09 | | 2 | ..HLDR, TERM CONN:10 WIRE, WHITE | 80009 | 352-0168-09 |
| | 175-0833-00 | | AR | ..CABLE, SP, ELEC:10,26 AWG STRD, PVC JKT, RBN ..(1.021 FT) | 08261 | 111-2699-970 |
| | 175-6209-00 | | 1 | ..CA ASSY, SP, ELEC:10,26 AWG,18.0 L,RIBBON ..(A6P3 TO A5P303) | 80009 | 175-6209-00 |
| | 131-0707-00 | | 20 | ..CONTACT, ELEC:22-26 AWG,BRS,CU BE GLD PL | 22526 | 47439-000 |
| | 352-0168-03 | | 2 | ..HLDR, TERM CONN:10 WIRE, ORANGE | 80009 | 352-0168-03 |
| | 175-0833-00 | | AR | ..CABLE, SP, ELEC:10,26 AWG STRD, PVC JKT, RBN ..(1.521 FT) | 08261 | 111-2699-970 |

Replaceable Mechanical Parts - 7904A

| Fig. & Index No. | Tektronix Part No. | Serial/Assembly No. Effective Dscnt | Qty | 12345 Name & Description | Mfr. Code | Mfr. Part No. |
|------------------|--------------------|-------------------------------------|-----|---|-----------|-----------------|
| 4- | 175-6210-00 | | 1 | .CA ASSY, SP, ELEC:10,26 AWG,22.0 L,RIBBON (A6P9 TO ASP309) | 80009 | 175-6210-00 |
| | 131-0707-00 | | 20 | ..CONTACT, ELEC:22-26 AWG,BRS,CU BE GLD PL | 22526 | 47439-000 |
| | 352-0168-09 | | 2 | ..HLDR, TERM CONN:10 WIRE,WHITE | 80009 | 352-0168-09 |
| | 175-0833-00 | | AR | ..CABLE, SP, ELEC:10,26 AWG STRD,PVC JKT,RBN ..(1.021 FT) | 08261 | 111-2699-970 |
| | 175-6211-00 | | 1 | .CA ASSY, SP, ELEC:10,26 AWG,15.5 L,RIBBON (POWER SUPPLY P82 TO A6P82) | 80009 | 175-6211-00 |
| -161 | 131-1810-00 | | 20 | ..CONTACT, ELEC:WIRE TO PIN,PH BRZ GOLD PL | 00779 | 87124-1 |
| | 204-0760-00 | | 2 | ..CONN BODY, RCPT:10 CONTACTS | 00779 | 2-87175-1 |
| | 175-0855-00 | | AR | ..CABLE, SP, ELEC:10,22 AWG,STRD,PVC,RBN ..(1.313 FT) | 08261 | SS-1022(1061)OC |
| | 175-4400-00 | | 1 | .CA ASSY, SP, ELEC:10,26 AWG,20.0 L,RIBBON (A6P2 TO ASP302) | 80009 | 175-4400-00 |
| | 131-0707-00 | | 20 | ..CONTACT, ELEC:22-26 AWG,BRS,CU BE GLD PL | 22526 | 47439-000 |
| | 352-0168-02 | | 2 | ..HLDR, TERM CONN:10 WIRE,RED | 80009 | 352-0168-02 |
| | 175-0833-00 | | AR | ..CABLE, SP, ELEC:10,26 AWG STRD,PVC JKT,RBN (1.688 FT) | 08261 | 111-2699-970 |
| | 175-3755-00 | | 1 | .CABLE ASSY, RF:50 OHM COAX,17.0 L,9-1 (A6J71 TO A5J301) | 80009 | 175-3755-00 |
| | 175-4097-00 | | 1 | .CABLE ASSY, RF:50 OHM COAX,12.0 L,9-0 (A6J90 TO READOUT BNC) | 80009 | 175-4097-00 |
| | 175-6212-00 | | 1 | .CABLE ASSY, RF:50 OHM COAX,18.0 L,6-N (A14J496 TO FRONT BNC) | 80009 | 175-6212-00 |
| | 175-6213-00 | | 1 | .CABLE ASSY, RF:50 OHM COAX,15.0 L,9-2 (A15J32 TO A21J78) | 80009 | 175-6213-00 |
| | 175-6214-00 | | 1 | .CABLE ASSY, RF:50 OHM COAX,15.0 L,9-6 (A13J4406 TO A2J110) | 80009 | 175-6214-00 |
| | 175-6215-00 | | 1 | .CABLE ASSY, RF:50 OHM COAX,30.0 L,9-6 (A1J1917 TO READOUT BNC) | 80009 | 175-6215-00 |
| | 175-6364-00 | | 1 | .CABLE ASSY, RF:50 OHM COAX,3.5 L,9-5 (A5J392 TO FRONT BNC) | 80009 | 175-6364-00 |
| | 195-7224-00 | | 1 | .LEAD, ELECTRICAL:18 AWG,14.0 L,5-4 (SHIELD STUD TO LEFT RAIL) | 80009 | 195-7224-00 |
| -162 | 210-0202-00 | | 2 | ..TERMINAL, LUG:0.146 IO,LOCKING,BRZ TIN PL | 86928 | A-373-158-2 |
| CABLE ASSEMBLIES | | | | | | |
| | 179-2578-00 | | 1 | WIRING HARNESS:SIGNAL OUT | 80009 | 179-2578-00 |
| | 175-7039-00 | | 1 | .CABLE ASSY, RF:50 OHM COAX,19.75 L,9-1 (TO A6J91) | 80009 | 175-7039-00 |
| | 131-0621-00 | | 1 | ..CONN, TERM:22-26 AWG,BRS,CU BE GLD PL | 22526 | 46231-000 |
| | 131-0792-00 | | 1 | ..CONNECTOR, TERM:18-20 AWG,CU BE GOLD PL | 22526 | 46221 |
| | 210-0774-00 | | 1 | ..EYELET, METALLIC:0.152 OD X 0.218 L,BRS | 80009 | 210-0774-00 |
| | 210-0775-00 | | 1 | ..EYELET, METALLIC:0.126 OD X 0.205 L,BRS | 80009 | 210-0775-00 |
| | 175-7038-00 | | 1 | .CABLE ASSY, RF:50 OHM COAX,19.25 L,9-2 (TO A6J92) | 80009 | 175-7038-00 |
| | 131-0621-00 | | 1 | ..CONN, TERM:22-26 AWG,BRS,CU BE GLD PL | 22526 | 46231-000 |
| | 131-0792-00 | | 1 | ..CONNECTOR, TERM:18-20 AWG,CU BE GOLD PL | 22526 | 46221 |
| | 210-0774-00 | | 1 | ..EYELET, METALLIC:0.152 OD X 0.218 L,BRS | 80009 | 210-0774-00 |
| | 210-0775-00 | | 1 | ..EYELET, METALLIC:0.126 OD X 0.205 L,BRS | 80009 | 210-0775-00 |
| | 175-7036-00 | | 1 | .CABLE ASSY, RF:50 OHM COAX,18.5 L,9-3 (TO A6J93) | 80009 | 175-7036-00 |
| | 131-0621-00 | | 1 | ..CONN, TERM:22-26 AWG,BRS,CU BE GLD PL | 22526 | 46231-000 |
| | 131-0792-00 | | 1 | ..CONNECTOR, TERM:18-20 AWG,CU BE GOLD PL | 22526 | 46221 |
| | 210-0774-00 | | 1 | ..EYELET, METALLIC:0.152 OD X 0.218 L,BRS | 80009 | 210-0774-00 |
| | 210-0775-00 | | 1 | ..EYELET, METALLIC:0.126 OD X 0.205 L,BRS | 80009 | 210-0775-00 |
| | 175-7037-00 | | 1 | .CABLE ASSY, RF:50 OHM COAX,17.5 L,9-4 (TO A6J99) | 80009 | 175-7037-00 |
| | 131-0621-00 | | 1 | ..CONN, TERM:22-26 AWG,BRS,CU BE GLD PL | 22526 | 46231-000 |
| | 131-0792-00 | | 1 | ..CONNECTOR, TERM:18-20 AWG,CU BE GOLD PL | 22526 | 46221 |
| | 210-0774-00 | | 1 | ..EYELET, METALLIC:0.152 OD X 0.218 L,BRS | 80009 | 210-0774-00 |
| | 210-0775-00 | | 1 | ..EYELET, METALLIC:0.126 OD X 0.205 L,BRS | 80009 | 210-0775-00 |
| -163 | 352-0204-00 | | 1 | .HLDR, TERM CONN:8 WIRE,BLACK (TO A1P900) | 80009 | 352-0204-00 |
| | 343-0549-00 | | 5 | .STRAP, TIEDOWN,E:0.091 W X 4.0 L,ZYTEL | 06383 | PLT1M |
| | 179-2579-00 | | 1 | WIRING HARNESS:AUXILIARY-Y | 80009 | 179-2579-00 |
| | 175-7132-00 | | 1 | .CABLE ASSY, RF:50 OHM COAX,23.5 L,9-2 | 80009 | 175-7132-00 |

| Fig. & Index No. | Tektronix Part No. | Serial/Assembly No. Effective Dscant | Qty | 12345 Name & Description | Mfr. Code | Mfr. Part No. |
|------------------|--------------------|--------------------------------------|-----|--|-----------|---------------|
| 4- | | | | (A15J92 TO A1J1992) | | |
| | 210-0774-00 | | 2 | .. EYELET, METALLIC: 0.152 OD X 0.218 L, BRS | 80009 | 210-0774-00 |
| | 210-0775-00 | | 2 | .. EYELET, METALLIC: 0.126 OD X 0.205 L, BRS | 80009 | 210-0775-00 |
| | 175-8519-00 | | 1 | .CABLE ASSY, RF: 50 OHM COAX, 26.75 L, 9-4 (TO A15J99) | 80009 | 175-8519-00 |
| | 131-0621-00 | | 1 | .. CONN, TERM: 22-26 AWG, BRS, CU BE GLD PL | 22526 | 46231-000 |
| | 131-0792-00 | | 1 | .. CONNECTOR, TERM: 18-20 AWG, CU BE GOLD PL | 22526 | 46221 |
| | 210-0774-00 | | 1 | .. EYELET, METALLIC: 0.152 OD X 0.218 L, BRS | 80009 | 210-0774-00 |
| | 210-0775-00 | | 1 | .. EYELET, METALLIC: 0.126 OD X 0.205 L, BRS | 80009 | 210-0775-00 |
| | 175-8520-00 | | 1 | .CABLE ASSY, RF: 50 OHM COAX, 26.25 L, 9-6 (TO A15J96) | 80009 | 175-8520-00 |
| | 131-0621-00 | | 1 | .. CONN, TERM: 22-26 AWG, BRS, CU BE GLD PL | 22526 | 46231-000 |
| | 131-0792-00 | | 1 | .. CONNECTOR, TERM: 18-20 AWG, CU BE GOLD PL | 22526 | 46221 |
| | 210-0774-00 | | 1 | .. EYELET, METALLIC: 0.152 OD X 0.218 L, BRS | 80009 | 210-0774-00 |
| | 210-0775-00 | | 1 | .. EYELET, METALLIC: 0.126 OD X 0.205 L, BRS | 80009 | 210-0775-00 |
| | 175-8521-00 | | 1 | .CABLE ASSY, RF: 50 OHM COAX, 19.5 L, 9-8 (A6J38 TO A15J38) | 80009 | 175-8521-00 |
| | 210-0774-00 | | 2 | .. EYELET, METALLIC: 0.152 OD X 0.218 L, BRS | 80009 | 210-0774-00 |
| | 210-0775-00 | | 2 | .. EYELET, METALLIC: 0.126 OD X 0.205 L, BRS | 80009 | 210-0775-00 |
| | 175-8522-00 | | 1 | .CABLE ASSY, RF: 50 OHM COAX, 12.0 L, 9-8 (A6J78 TO A15J38) | 80009 | 175-8522-00 |
| | 131-0621-00 | | 1 | .. CONN, TERM: 22-26 AWG, BRS, CU BE GLD PL | 22526 | 46231-000 |
| | 131-0792-00 | | 1 | .. CONNECTOR, TERM: 18-20 AWG, CU BE GOLD PL | 22526 | 46221 |
| | 210-0774-00 | | 1 | .. EYELET, METALLIC: 0.152 OD X 0.218 L, BRS | 80009 | 210-0774-00 |
| | 210-0775-00 | | 1 | .. EYELET, METALLIC: 0.126 OD X 0.205 L, BRS | 80009 | 210-0775-00 |
| | 175-8523-00 | | 1 | .CABLE ASSY, RF: 50 OHM COAX, 13.0 L, 9-N (A15J39 TO A6J39) | 80009 | 175-8523-00 |
| | 175-1255-00 | | AR | .. CABLE, RF: 50 OHM COAX, WHITE VINYL JKT (1.083 FT) | 80009 | 175-1255-00 |
| | 210-0774-00 | | 2 | .. EYELET, METALLIC: 0.152 OD X 0.218 L, BRS | 80009 | 210-0774-00 |
| | 210-0775-00 | | 2 | .. EYELET, METALLIC: 0.126 OD X 0.205 L, BRS | 80009 | 210-0775-00 |
| -164 | 352-0202-00 | | 1 | .HLDR, TERM CONN: 6 WIRE, BLACK (TO A29P90) | 80009 | 352-0202-00 |
| | 343-0549-00 | | 9 | .STRAP, TIEDOWN, E: 0.091 W X 4.0 L, ZYTEL | 06383 | PLT1M |

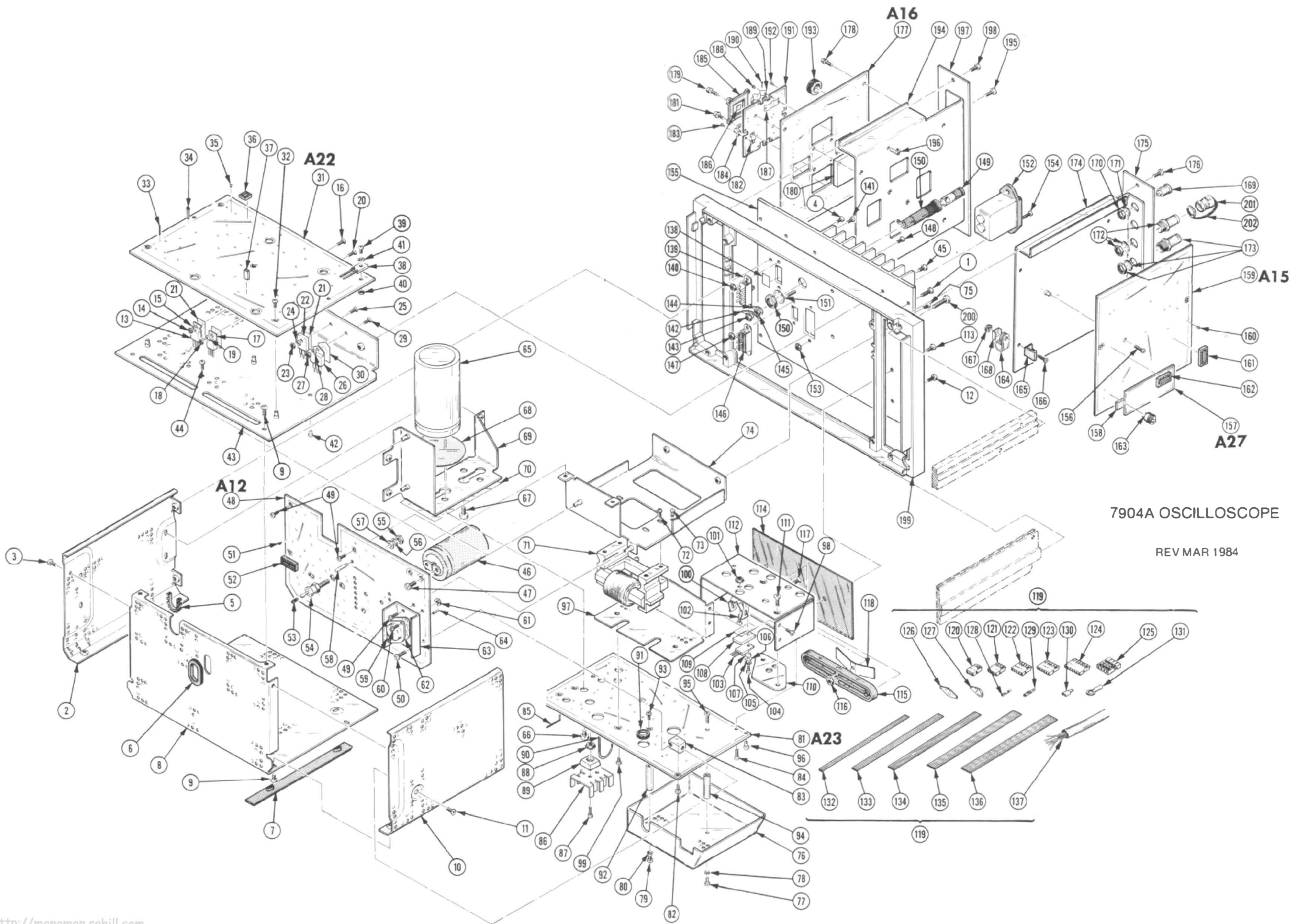

7904A OSCILLOSCOPE

REV MAR 1984

Replaceable Mechanical Parts - 7904A

| Fig. & Index No. | Tektronix Part No. | Serial/Assembly No. Effective | Discnt | Qty | 12345 Name & Description | Mfr. Code | Mfr. Part No. |
|------------------|--------------------|-------------------------------|---------|-----|--|-----------|-----------------|
| 5- | 620-0283-01 | B010100 | B019999 | 1 | POWER SUPPLY:LOW VOLTAGE | 80009 | 620-0283-01 |
| | 620-0283-02 | B020000 | | 1 | POWER SUPPLY: (ATTACHING PARTS) | 80009 | 620-0283-02 |
| -1 | 211-0578-00 | | | 4 | SCREW,MACHINE:6-32 X 0.438,PNH,STL (END ATTACHING PARTS) | 93907 | ORDER BY DESCR |
| -2 | 200-1262-02 | | | 1 | POWER SUPPLY INCLUDES: .COVER,PWR SPLY:LEFT SIDE (ATTACHING PARTS) | 80009 | 200-1262-02 |
| -3 | 211-0503-00 | | | 4 | .SCREW,MACHINE:6-32 X 0.188,PNH,STL | 93907 | ORDER BY DESCR |
| -4 | 211-0504-00 | | | 2 | .SCREW,MACHINE:6-32 X 0.250,PNH,STL (END ATTACHING PARTS) | TK0435 | ORDER BY DESCR |
| -5 | 255-0334-00 | | | AR | .PLASTIC CHANNEL:12.75 X 0.175 X 0.155,NYLON | 11897 | 122-37-2500 |
| -6 | 348-0233-00 | | | 1 | .GROMMET,PLASTIC:GRAY,OBLONG 0.847 X 0.347 | 80009 | 348-0233-00 |
| -7 | 351-0279-00 | | | 2 | .GUIDE,SHOE:5.18 X 0.375,NYLON | 80009 | 351-0279-00 |
| -8 | 200-1906-00 | | | 1 | .COVER,PWR SPLY:BOTTOM & FRONT (ATTACHING PARTS) | 80009 | 200-1906-00 |
| -9 | 211-0503-00 | | | 5 | .SCREW,MACHINE:6-32 X 0.188,PNH,STL (END ATTACHING PARTS) | 93907 | ORDER BY DESCR |
| -10 | 200-1263-01 | | | 1 | .COVER,PWR SPLY:RIGHT SIDE (ATTACHING PARTS) | 80009 | 200-1263-01 |
| -11 | 211-0503-00 | | | 1 | .SCREW,MACHINE:6-32 X 0.188,PNH,STL | 93907 | ORDER BY DESCR |
| -12 | 211-0507-00 | | | 2 | .SCREW,MACHINE:6-32 X 0.312,PNH,STL (END ATTACHING PARTS) | 83385 | ORDER BY DESCR |
| -13 | ----- | | | 2 | .TRANSISTOR:(SEE Q28,Q74 REPL) (ATTACHING PARTS) | | |
| -14 | 210-0406-00 | | | 2 | .NUT,PLAIN,HEX:4-40 X 0.188,BRS CD PL | 73743 | 12161-50 |
| -15 | 210-1178-00 | | | 2 | .WASHER,SHLDR: | 13103 | 7721-7PPS |
| -16 | 211-0101-00 | | | 2 | .SCREW,MACHINE:4-40 X 0.25,FLH,100 DEG,STL (END ATTACHING PARTS) | 93907 | ORDER BY DESCR |
| -17 | ----- | | | 2 | .TRANSISTOR:(SEE Q58,Q94 REPL) (ATTACHING PARTS) | | |
| -18 | 210-0406-00 | | | 2 | .NUT,PLAIN,HEX:4-40 X 0.188,BRS CD PL | 73743 | 12161-50 |
| -19 | 210-1178-00 | | | 2 | .WASHER,SHLDR: | 13103 | 7721-7PPS |
| -20 | 211-0101-00 | | | 2 | .SCREW,MACHINE:4-40 X 0.25,FLH,100 DEG,STL (END ATTACHING PARTS) | 93907 | ORDER BY DESCR |
| -21 | 342-0202-00 | | | 5 | .INSULATOR,PLATE:TRANSISTOR,MICA | 91500 | 10-21-023-106 |
| -22 | ----- | | | 1 | .TRANSISTOR:(SEE Q12 REPL) (ATTACHING PARTS) | | |
| -23 | 210-0406-00 | | | 1 | .NUT,PLAIN,HEX:4-40 X 0.188,BRS CD PL | 73743 | 12161-50 |
| -24 | 210-1178-00 | | | 1 | .WASHER,SHLDR: | 13103 | 7721-7PPS |
| -25 | 211-0038-00 | | | 1 | .SCREW,MACHINE:4-40 X 0.312,FLH,100 DEG,STL (END ATTACHING PARTS) | 93907 | ORDER BY DESCR |
| -26 | ----- | | | 1 | .TRANSISTOR:(SEE Q126 REPL) (ATTACHING PARTS) | | |
| -27 | 210-0406-00 | | | 1 | .NUT,PLAIN,HEX:4-40 X 0.188,BRS CD PL | 73743 | 12161-50 |
| -28 | 210-1178-00 | | | 1 | .WASHER,SHLDR: | 13103 | 7721-7PPS |
| -29 | 211-0101-00 | | | 1 | .SCREW,MACHINE:4-40 X 0.25,FLH,100 DEG,STL (END ATTACHING PARTS) | 93907 | ORDER BY DESCR |
| -30 | 342-0311-00 | | | 1 | .INSULATOR,PLATE:TRANSISTOR,MICA | 01295 | 64-21-023-212 |
| -31 | ----- | | | 1 | .CKT BOARD ASSY:LV REGULATOR(SEE A22 REPL) (ATTACHING PARTS) | | |
| -32 | 211-0008-00 | | | 5 | .SCREW,MACHINE:4-40 X 0.25,PNH,STL (END ATTACHING PARTS) .CKT BOARD ASSY INCLUDES: | 93907 | ORDER BY DESCR |
| -33 | 131-0608-00 | | | 51 | ..TERMINAL,PIN:0.365 L X 0.025 BRZ GLD PL | 22526 | 48283-036 |
| -34 | 214-0579-00 | | | 6 | ..TERM,TEST POINT:BRS CD PL | 80009 | 214-0579-00 |
| -35 | 136-0252-07 | | | 24 | ..SOCKET,PIN CONN:W/O DIMPLE | 22526 | 75060-012 |
| -36 | 136-0727-00 | | | 5 | ..SKT,PL-IN ELEK:MICROCKT,8 CONTACT | 09922 | D1LB8P-108 |
| -37 | 131-0993-00 | | | 1 | ..BUS,CONDUCTOR:SHUNT ASSEMBLY,BLACK | 22526 | 65474-005 |
| -38 | ----- | | | 1 | ..TRANSISTOR:(SEE Q148 REPL) (ATTACHING PARTS) | | |
| -39 | 211-0097-00 | | | 1 | ..SCREW,MACHINE:4-40 X 0.312,PNH,STL | 93907 | ORDER BY DESCR |
| -40 | 210-0551-00 | | | 1 | ..NUT,PLAIN,HEX:4-40 X 0.25,ST CD PL | TK0435 | ORDER BY DESCR |
| -41 | 210-1178-00 | | | 1 | ..WASHER,SHLDR: (END ATTACHING PARTS) | 13103 | 7721-7PPS |
| -42 | 348-0023-00 | | | 1 | ..PLUG,HOLE:U/WO.14 DIA HOLE,WHT PLSTC | 02768 | 207090201000101 |
| -43 | 441-1490-00 | | | 1 | ..CHASSIS,SCOPE:CIRCUIT BOARD (ATTACHING PARTS) | 80009 | 441-1490-00 |

| Fig. & Index No. | Tektronix Part No. | Serial/Assembly No. | | Qty | 12345 Name & Description | Mfr. Code | Mfr. Part No. |
|------------------|--------------------|---------------------|---------|-----|--|-----------|-----------------|
| | | Effective | Discnt | | | | |
| 5-44 | 211-0008-00 | | | 2 | .SCREW,MACHINE:4-40 X 0.25,PNH,STL | 93907 | ORDER BY DESCR |
| -45 | 211-0507-00 | | | 3 | .SCREW,MACHINE:6-32 X 0.312,PNH,STL | 83385 | ORDER BY DESCR |
| -46 | ----- | | | 1 | .(END ATTACHING PARTS) .CAPACITOR:(SEE C154 REPL) | | |
| -47 | 212-0518-00 | | | 2 | .SCREW,MACHINE:10-32 X 0.312,PNH,STL | 93907 | ORDER BY DESCR |
| -48 | ----- | | | 1 | .(END ATTACHING PARTS) .CKT BOARD ASSY:CONTROL RECT(SEE A12 REPL) | | |
| -49 | 211-0008-00 | | | 3 | .SCREW,MACHINE:4-40 X 0.25,PNH,STL | 93907 | ORDER BY DESCR |
| -50 | 211-0504-00 | | | 1 | .SCREW,MACHINE:6-32 X 0.250,PNH,STL | TK0435 | ORDER BY DESCR |
| -51 | 136-0252-07 | | | 6 | ..SOCKET,PIN CONN:W/O DIMPLE | 22526 | 75060-012 |
| -52 | 136-0729-00 | | | 1 | ..SKT,PL-IN ELEK:MICROCKT,16 CONTACT | 09922 | D1LB16P-108T |
| -53 | 136-0263-07 | | | 6 | ..SOCKET,PIN TERM:U/W 0.025 SQ PIN | 22526 | ORDER BY DESCR |
| -54 | ----- | | | 4 | ..SEMINCOND DEVICE:(SEE CR140,CR141,CR142 ..AND CR143 REPL) | | |
| -55 | 210-0410-00 | | | 4 | ..NUT,PLAIN,HEX:10-32 X 0.312,BRS CD PL | 73743 | 2X-2003-402 |
| -56 | 210-0056-00 | | | 4 | ..WASHER,LOCK:#10 SPLIT,0.047 THK,SI BRZ | 86928 | ORDER BY DESCR |
| -57 | 210-1003-00 | | | 4 | ..WASHER,FLAT:0.2 ID X 0.438 OD X 0.036 BRS | 86928 | 5714-50-32N |
| -58 | 386-1559-00 | | | 2 | ..SPACER,CKT BD:0.47 H,ACETAL | 80009 | 386-1559-00 |
| -59 | ----- | | | 1 | ..SEMICONV DEVICE:(SEE CR151 REPL) | | |
| -60 | 211-0012-00 | | | 2 | ..SCREW,MACHINE:4-40 X 0.375,PNH,STL | 93907 | ORDER BY DESCR |
| -61 | 210-0586-00 | | | 2 | ..NUT,PL,ASSEM WA:4-40 X 0.25,STL CO PL | 78189 | 211-041800-00 |
| -62 | 342-0567-00 | | | 1 | ..INSULATOR,PLATE:TRANSISTOR,SILICONE RUBBER | 18565 | 60-11-4511-167 |
| -63 | 214-2731-00 | | | 1 | ..HEAT SINK,DIODE:TO-3,AL | 80009 | 214-2731-00 |
| -64 | 136-0254-01 | B010100 | B031832 | 2 | ..SOCKET,PIN TERM:U/W 0.031 TO 0.04 DIA PIN | 00779 | 1-331892-8 |
| -65 | ----- | | | 2 | .CAPACITOR:(SEE C16,C17 REPL) | | |
| -66 | 212-0518-00 | | | 4 | .SCREW,MACHINE:10-32 X 0.312,PNH,STL | 93907 | ORDER BY DESCR |
| -67 | 212-0651-00 | | | 4 | .SCREW,MACHINE:10-32 X 0.312 L,PNH,NYLON | TK1281 | 011032P031 |
| | 210-3057-00 | | | 4 | .WASHER,FLAT:0.17 ID X 0.35 OD X 0.03,NYL | 85480 | LWNY-012NA-M |
| -68 | 342-0419-00 | | | 2 | ..INSULATOR,CAP: | TK1316 | ORDER BY DESCR |
| -69 | 407-2111-00 | | | 1 | .BRACKET,CAP.:ALUMINUM | 80009 | 407-2111-00 |
| -70 | 342-0452-00 | B010100 | B021199 | 1 | ..INSULATOR,FILM:CIRCUIT BOARD,POLYIMIDE | TK1316 | ORDER BY DESCR |
| -71 | ----- | | | 1 | ..TRANSFORMER:(SEE T110 REPL) | | |
| -72 | 211-0008-00 | | | 4 | .SCREW,MACHINE:4-40 X 0.25,PNH,STL | 93907 | ORDER BY DESCR |
| -73 | 348-0023-00 | | | 1 | .PLUG,HOLE:U/WO.14 DIA HOLE,WHT PLSTC | 02768 | 207090201000101 |
| -74 | 441-1423-00 | | | 1 | .CHASSIS,SCOPE:TRANSFORMER | 80009 | 441-1423-00 |
| -75 | 211-0097-00 | | | 2 | .SCREW,MACHINE:4-40 X 0.312,PNH,STL | 93907 | ORDER BY DESCR |
| -76 | 337-1490-02 | | | 1 | .SHIELD,ELEC:LINE INVERTER,CKT BD BOTTOM | 80009 | 337-1490-02 |
| -77 | 211-0558-00 | | | 1 | .SCREW,MACHINE:6-32 X 0.25,BDGH,NYL | 26365 | ORDER BY DESCR |
| -78 | 210-0055-00 | | | 1 | .WASHER,LOCK:#6 SPLIT,0.031 THK,STL | 81350 | ORDER BY DESCR |
| -79 | 211-0040-00 | | | 1 | .SCREW,MACHINE:4-40 X 0.25,BDGH,NYL | 26365 | ORDER BY DESCR |
| -80 | 210-0054-00 | | | 1 | .WASHER,LOCK:#4 SPLIT,0.025 THK STL | 78189 | ORDER BY DESCR |
| -81 | ----- | | | 1 | .(END ATTACHING PARTS) .CKT BOARD ASSY:INVERTER(SEE A23 REPL) | | |
| -82 | 211-0503-00 | | | 1 | .SCREW,MACHINE:6-32 X 0.188,PNH,STL | 93907 | ORDER BY DESCR |
| -83 | 220-0623-00 | | | 1 | .NUT BLOCK:6-32 X 0.375 X 0.5 X 0.448 | TK1465 | ORDER BY DESCR |
| -84 | 211-0008-00 | | | 4 | .SCREW,MACHINE:4-40 X 0.25,PNH,STL | 93907 | ORDER BY DESCR |
| -85 | 131-0591-00 | | | 6 | ..TERMINAL,PIN:0.835 L X 0.025 SQ PH BRZ | 22526 | 47332 |
| -86 | 214-1914-00 | | | 1 | ..HEAT SINK,DIODE:(2)0.15 DIA HOLES,AL | 98978 | P81-2CB |
| -87 | 211-0012-00 | B010100 | B042049 | 1 | ..SCREW,MACHINE:4-40 X 0.375,PNH,STL | 93907 | ORDER BY DESCR |

Replaceable Mechanical Parts - 7904A

| Fig. & Index No. | Tektronix Part No. | Serial/Assembly No. Effective | Discort | Qty | 12345 Name & Description | Mfr. Code | Mfr. Part No. |
|------------------|--------------------|-------------------------------|---------|-----|---|-----------|------------------|
| 5- | 211-0014-00 | B042050 | | 1 | ..SCREW,MACHINE:4-40 X 0.5,PNH,STL | 93907 | ORDER BY DESCR |
| | 210-0006-00 | B042050 | | 1 | ..WASHER,LOCK:#6 INTL,0.018 THK,STL | 77900 | 1206-00-00-0541C |
| -88 | 210-0406-00 | | | 1 | ..NUT,PLAIN,HEX:4-40 X 0.188,BRS CD PL ..(END ATTACHING PARTS) | 73743 | 12161-50 |
| -89 | 361-0414-00 | | | 1 | ..SPACER,DIODE:0.238 X 0.64 X 0.425,NYLON | 80009 | 361-0414-00 |
| -90 | 346-0032-00 | | | 1 | ..STRAP,RETAINING:0.075 DIA X 4.0 L,MLD RBR | 98159 | 2829-75-4 |
| -91 | 348-0005-00 | | | 1 | ..GROMMET,RUBBER:BLACK,ROUND,0.375 ID | 70485 | 230X-36017 |
| -92 | 129-0323-00 | | | 1 | ..SPACER,POST:1.0 L,4-40 EA END,AL,0.25 HEX ..(ATTACHING PARTS) | 80009 | 129-0323-00 |
| -93 | 211-0097-00 | | | 1 | ..SCREW,MACHINE:4-40 X 0.312,PNH,STL ..(END ATTACHING PARTS) | 93907 | ORDER BY DESCR |
| -94 | 385-0016-00 | | | 1 | ..SPACER,POST:1.0 L W/6-32 THD THRU,NYLON ..(ATTACHING PARTS) | 80009 | 385-0016-00 |
| -95 | 211-0507-00 | | | 1 | ..SCREW,MACHINE:6-32 X 0.312,PNH,STL ..(END ATTACHING PARTS) | 83385 | ORDER BY DESCR |
| -96 | 134-0158-00 | | | 4 | ..BUTTON,PLUG:0.187 DIA,NYLON | 02768 | 207-080501-00 |
| -97 | 337-2533-00 | | | 1 | ..SHIELD,ELEC:LINE INVERT, TOP ..(ATTACHING PARTS) | 80009 | 337-2533-00 |
| -98 | 211-0101-00 | | | 4 | ..SCREW,MACHINE:4-40 X 0.25,FLH,100 DEG,STL | 93907 | ORDER BY DESCR |
| -99 | 211-0504-00 | | | 2 | ..SCREW,MACHINE:6-32 X 0.250,PNH,STL ..(END ATTACHING PARTS) | TK0435 | ORDER BY DESCR |
| -100 | 344-0118-00 | | | 2 | ..RTNR,CAPACITOR:1.0 DIA,STEEL ..(ATTACHING PARTS) | 80033 | E50008 -044 |
| -101 | 210-0586-00 | | | 2 | ..NUT,PL,ASSEM WA:4-40 X 0.25,STL CD PL | 78189 | 211-041800-00 |
| -102 | 211-0008-00 | | | 2 | ..SCREW,MACHINE:4-40 X 0.25,PNH,STL ..(END ATTACHING PARTS) | 93907 | ORDER BY DESCR |
| -103 | ----- | | | 2 | ..TRANSISTOR:(SEE Q34,Q40 REPL) ..(ATTACHING PARTS) | | |
| -104 | 211-0034-00 | | | 2 | ..SCREW,MACHINE:2-56 X 0.5,PNH,STL | 06950 | ORDER BY DESCR |
| -105 | 210-0053-00 | | | 2 | ..WASHER,LOCK:#2 SPLIT,0.02 THK STL | 78189 | ORDER BY DESCR |
| -106 | 210-1008-00 | | | 2 | ..WASHER,FLAT:0.09 ID X 0.188 OD X 0.02,BRS | 12327 | ORDER BY DESCR |
| -107 | 342-0421-00 | | | 2 | ..INSULATOR,BSHG:0.089 ID X 0.24 OD 0.23 NYL ..(END ATTACHING PARTS) | 80009 | 342-0421-00 |
| -108 | 342-0420-00 | | | 2 | ..INSULATOR,PLATE:TRANSISTOR,PORCELAIN | 80009 | 342-0420-00 |
| -109 | 342-0202-00 | | | 2 | ..INSULATOR,PLATE:TRANSISTOR,MICA | 91500 | 10-21-023-106 |
| -110 | 386-2634-00 | | | 1 | ..PL,CHOKE MTG: ..(ATTACHING PARTS) | 80009 | 386-2634-00 |
| -111 | 211-0619-00 | | | 2 | ..SCREW,MACHINE:6-32 X 1.5,FLH,100 DEG,STL ..(END ATTACHING PARTS) | TK0433 | ORDER BY DESCR |
| -112 | 441-1420-00 | | | 1 | ..CHASSIS,SCOPE:LINE INVERT ..(ATTACHING PARTS) | 80009 | 441-1420-00 |
| -113 | 213-0041-00 | | | 2 | ..SCREW,TPG,TC:6-32 X 0.375,TYPE T,TRH,STL ..(END ATTACHING PARTS) | 93907 | ORDER BY DESCR |
| -114 | 342-0193-00 | | | 1 | ..INSULATOR,FILM:POWER SUPPLY,POLYIMIDE | 80009 | 342-0193-00 |
| -115 | 342-0103-00 | | | 1 | ..INSULATOR,BLOCK:HEAT-SINK SHIELD,NYLON ..(ATTACHING PARTS) | 80009 | 342-0103-00 |
| -116 | 210-0457-00 | | | 1 | ..NUT,PL,ASSEM WA:6-32 X 0.312,STL CD PL | 78189 | 511-061800-00 |
| -117 | 211-0512-00 | | | 1 | ..SCREW,MACHINE:6-32 X 0.5,FLH,100 DEG,STL ..(END ATTACHING PARTS) | TK0435 | ORDER BY DESCR |
| -118 | 214-1625-00 | | | 1 | ..SPRING,FLAT:2.0 X 0.438,CU BE | 80009 | 214-1625-00 |
| -119 | 198-3829-00 | B010100 | B021129 | 1 | ..WIRE SET,ELEC: | 80009 | 198-3829-00 |
| | 198-3829-01 | B021130 | | 1 | ..WIRE SET,ELEC: | 80009 | 198-3829-01 |
| -120 | 352-0161-09 | | | 1 | ..HLDR,TERM CONN:3 WIRE,WHITE ..(A22P99 TO S99) | 80009 | 352-0161-09 |
| -121 | 352-0162-04 | | | 2 | ..HLDR,TERM CONN:4 WIRE,YELLOW ..(A22P54 TO A12P54) | 80009 | 352-0162-04 |
| -122 | 352-0163-08 | | | 2 | ..HLDR,TERM CONN:5 WIRE,GRAY ..(A22P48 TO A12P48) | 80009 | 352-0163-08 |
| -123 | 352-0164-02 | | | 2 | ..HLDR,TERM CONN:6 WIRE,RED ..(A22P52 TO A12P52) | 80009 | 352-0164-02 |
| -124 | 352-0165-00 | | | 2 | ..HLDR,TERM CONN:7 WIRE,BLACK ..(A22P50 TO A12P50) | 80009 | 352-0165-00 |
| -125 | 352-0200-00 | | | 2 | ..HLDR,TERM CONN:4 WIRE,BLACK ..(A22P50 TO A12P50) | 80009 | 352-0200-00 |
| -126 | 210-0204-00 | | | 1 | ..TERMINAL,LUG:0.142 ID,LOCKING,BRZ TINNED | 86928 | A373-175 |
| -127 | 210-0202-00 | | | 2 | ..TERMINAL,LUG:0.146 ID,LOCKING,BRZ TIN PL | 86928 | A-373-158-2 |
| -128 | 131-0707-00 | | | 47 | ..CONTACT,ELEC:22-26 AWG,BRS,CU BE GLD PL | 22526 | 47439-000 |

| Fig. & Index No. | Tektronix Part No. | Serial/Assembly No. Effective | Discont | Qty | 12345 Name & Description | Mfr. Code | Mfr. Part No. |
|------------------|--------------------|-------------------------------|---------|-----|---|-----------|----------------|
| 5-129 | 131-0622-00 | | | 8 | ..CONTACT,ELEC:28-32 AWG,BRS & CU BE GLD PL | 22526 | 46241-000 |
| | 131-0792-00 | | | 8 | ..CONNECTOR,TERM:18-20 AWG,CU BE GOLD PL | 22526 | 46221 |
| -130 | 131-2065-00 | | | 4 | ..TERM,QIK DISC.:18-22 AWG,BRASS TIN PLATED | 00779 | 2-520181-2 |
| -131 | 210-0307-00 | | | 2 | ..TERMINAL,LUG:#8,RING,SOLDERLESS,CU TIN PL | 09922 | BA14E-8M |
| -132 | 175-0826-00 | | | AR | ..CABLE,SP,ELEC:3,26 AWG,STRD,PVC JKT,RBN | 80009 | 175-0826-00 |
| -133 | 175-0827-00 | | | AR | ..CABLE,SP,ELEC:4,26 AWG,STRD,PVC JKT,RBN | 08261 | 111-2699-954 |
| -134 | 175-0860-00 | | | AR | ..CABLE,SP,ELEC:5,22 AWG,STRD,PVC JKT,RBN | TK0846 | 05CF22M7-BBT |
| -135 | 175-0859-00 | | | AR | ..CABLE,SP,ELEC:6,22 AWG,STRD,PVC JKT,RBN | TK0846 | 06CF22M7-BBT |
| -136 | 175-0858-00 | | | AR | ..CABLE,SP,ELEC:7,22 AWG,STRD,PVC INSUL,RBN | TK0846 | 07CF22M7-BBT |
| -137 | 175-1091-00 | | | AR | ..CABLE,SP,ELEC:4,18 AWG,STRD BRAIDED SHLD | 80009 | 175-1091-00 |
| -138 | 334-3379-01 | | | 1 | .MARKER,IDENT:MARKED GROUND SYMBOL | 80009 | 334-3379-01 |
| -139 | ----- | | | 1 | .SWITCH,SLIDE:(SEE S99 REPL) | | |
| | | | | 1 | .(ATTACHING PARTS) | | |
| -140 | 210-0586-00 | | | 2 | .NUT,PL,ASSEM WA:4-40 X 0.25,STL CD PL | 78189 | 211-041800-00 |
| -141 | 211-0097-00 | | | 2 | .SCREW,MACHINE:4-40 X 0.312,PNH,STL | 93907 | ORDER BY DESCR |
| | | | | | .(END ATTACHING PARTS) | | |
| -142 | 210-0204-00 | | | 1 | .TERMINAL,LUG:0.142 ID,LOCKING,BRZ TINNED | 86928 | A373-175 |
| | | | | | .(ATTACHING PARTS) | | |
| -143 | 210-0407-00 | | | 1 | .NUT,PLAIN,HEX:6-32 X 0.25,BRS CD PL | 73743 | 3038-402 |
| | 210-0457-00 | 8042080 | | 1 | .NUT,PL,ASSEM WA:6-32 X 0.312,STL CD PL | 78189 | 511-061800-00 |
| | | | | | .(END ATTACHING PARTS) | | |
| -144 | 210-0202-00 | | | 1 | .TERMINAL,LUG:0.146 ID,LOCKING,BRZ TIN PL | 86928 | A-373-158-2 |
| | | | | | .(ATTACHING PARTS) | | |
| -145 | 210-0407-00 | | | 2 | .NUT,PLAIN,HEX:6-32 X 0.25,BRS CD PL | 73743 | 3038-402 |
| | | | | | .(END ATTACHING PARTS) | | |
| -146 | ----- | | | 1 | .SWITCH,SLIDE:(SEE S12 REPL) | | |
| | | | | | .(ATTACHING PARTS) | | |
| -147 | 210-0586-00 | | | 2 | .NUT,PL,ASSEM WA:4-40 X 0.25,STL CD PL | 78189 | 211-041800-00 |
| -148 | 211-0097-00 | | | 2 | .SCREW,MACHINE:4-40 X 0.312,PNH,STL | 93907 | ORDER BY DESCR |
| | | | | | .(END ATTACHING PARTS) | | |
| -149 | 200-2264-00 | | | 1 | .CAP,FUSEHOLDER:3AG FUSES | S3629 | FEK 031 1666 |
| -150 | 204-0832-00 | | | 1 | .BOOY,FUSEHOLDER:3AG & 5 X 20MM FUSES | TK0861 | 031 1673 |
| -151 | 210-1039-00 | | | 1 | .WASHER,LOCK:0.521 ID,INT,0.025 THK,SST | 24931 | ORDER BY DESCR |
| -152 | ----- | | | 1 | .FILTER,RFI:(SEE FL10 REPL) | | |
| | | | | | .(ATTACHING PARTS) | | |
| -153 | 210-0586-00 | 8010100 | 8042079 | 2 | .NUT,PL,ASSEM WA:4-40 X 0.25,STL CD PL | 78189 | 211-041800-00 |
| -154 | 211-0014-00 | | | 2 | .SCREW,MACHINE:4-40 X 0.5,PNH,STL | 93907 | ORDER BY DESCR |
| | | | | | .(END ATTACHING PARTS) | | |
| -155 | 214-2932-00 | 8010100 | 8041939 | 1 | .HEAT SINK,ELEC:POWER SUPPLY,AL | 80009 | 214-2932-00 |
| | 214-2932-01 | 8041940 | | 1 | .HEAT SINK,ELEC:POWER SUPPLY,ALUMINUM | 80009 | 214-2932-01 |
| | 334-1377-00 | | | 1 | .MARKER,IDENT:MKD IDENTIFICATION NO. | 80009 | 334-1377-00 |
| | | | | | .(OPTION 03 ONLY) | | |
| | | | | | CKT BOARD ASSY:READOUT PROTECTION #1 | | |
| | | | | | (SEE A15,A27 REPL) | | |
| | | | | | (ATTACHING PARTS) | | |
| -156 | 211-0008-00 | | | 1 | SCREW,MACHINE:4-40 X 0.25,PNH,STL | 93907 | ORDER BY DESCR |
| | | | | | (END ATTACHING PARTS) | | |
| | | | | | READOUT PROT ASSY INCLUDES: | | |
| -157 | ----- | | | 1 | .CKT BOARD ASSY:READOUT PROTECTION # 1 | | |
| | | | | | .(SEE A27 REPL) | | |
| -158 | 253-0160-00 | | | AR | ..TAPE,PRESS SENS:POLY SPONGE,0.25 X 0.062 | 04963 | 4116 TYPE A |
| -159 | ----- | | | 1 | .CKT BOARD ASSY:READOUT(SEE A15 REPL) | | |
| -160 | 136-0252-07 | 8010100 | 8029999 | 45 | ..SOCKET,PIN CONN:W/O DIMPLE | 22526 | 75060-012 |
| | 136-0252-07 | 8030000 | | 6 | ..SOCKET,PIN CONN:W/O DIMPLE | 22526 | 75060-012 |
| | 136-0751-00 | 8030000 | | 1 | ..SKT,PL-IN ELEK:MICROCKT,24 PIN | 09922 | DILB24P108 |
| -161 | 136-0729-00 | 8010100 | 8029999 | 14 | ..SKT,PL-IN ELEK:MICROCKT,16 CONTACT | 09922 | DILB16P-108T |
| -162 | 136-0728-00 | 8010100 | 8029999 | 3 | ..SKT,PL-IN ELEK:MICROCKT,14 CONTACT | 09922 | DILB14P-108 |
| -163 | 136-0235-00 | 8010100 | 8029999 | 1 | ..SKT,PL-IN ELEK:TRANSISTOR,6 CONTACT | 71785 | 133-96-12-062 |
| | 131-0608-00 | | | 40 | ..TERMINAL,PIN:0.365 L X 0.025 BRZ GLD PL | 22526 | 48283-036 |
| | 131-0993-00 | 8030000 | | 3 | ..BUS,CONDUCTOR:SHUNT ASSEMBLY,BLACK | 22526 | 65474-005 |
| -164 | 343-0006-00 | | | 2 | CLAMP,LOOP:0.5 ID,PLASTIC | 06915 | ORDER BY DESCR |
| -165 | 344-0133-00 | | | 4 | CLIP,SPR TNSN:CKT BOARD MT,WHITE | 80009 | 344-0133-00 |
| | | | | | (ATTACHING PARTS) | | |
| -166 | 211-0198-00 | | | 2 | SCREW,MACHINE:4-40 X 0.438,PNH,STL | TK0435 | ORDER BY DESCR |
| | 211-0007-00 | | | 2 | SCREW,MACHINE:4-40 X 0.188,PNH,STL | 93907 | ORDER BY DESCR |
| -167 | 210-0586-00 | | | 2 | NUT,PL,ASSEM WA:4-40 X 0.25,STL CD PL | 78189 | 211-041800-00 |
| -168 | 210-0863-00 | | | 2 | WSHR,LOOP CLAMP:0.091 ID U/W 0.5 W CLP,STL | 95987 | C191 |
| | | | | | (END ATTACHING PARTS) | | |

Replaceable Mechanical Parts - 7904A

| Fig. & Index No. | Tektronix Part No. | Serial/Assembly No. Effective | Dscont | Qty | 12345 Name & Description | Mfr. Code | Mfr. Part No. |
|------------------|--------------------|-------------------------------|---------|-----|--|-----------|----------------|
| 5-169 | 131-0771-00 | | | 2 | CONN,RCPT,ELEC:2 MALE,2 FEM,PNL MT W/O MTG HDW (ATTACHING PARTS) | 91836 | 1904-2M58 |
| -170 | 220-0551-00 | | | 2 | NUT,PLAIN,HEX:9 MM X 1.00,BRS NP | 73743 | ORDER BY DESCR |
| -171 | 210-0012-00 | | | 2 | WASHER,LOCK:0.384 ID,INTL,0.022 THK,STL (END ATTACHING PARTS) | 09772 | ORDER BY DESCR |
| -172 | 131-0955-00 | | | 3 | CONN,RCPT,ELEC:BNC,FEMALE | 13511 | 31-279 |
| -173 | 131-1315-01 | | | 3 | CONN,RCPT,ELEC:BNC,FEMALE | 80009 | 131-1315-01 |
| -174 | 441-1377-00 | | | 1 | CHASSIS,SCOPE:READOUT | 80009 | 441-1377-00 |
| -175 | 333-2321-00 | | | 1 | PANEL,REAR:READOUT (ATTACHING PARTS) | 80009 | 333-2321-00 |
| -176 | 211-0507-00 | | | 2 | SCREW,MACHINE:6-32 X 0.312,PNH,STL (END ATTACHING PARTS) | 83385 | ORDER BY DESCR |
| -177 | ----- | | | 1 | CKT BOARD ASSY:VERT CHAN SW(SEE A16 REPL) (ATTACHING PARTS) | | |
| -178 | 211-0292-00 | B010100 | B021587 | 4 | SCR,ASSEM WSHR:4-40 X 0.29,PNH,BRS NI PL | 78189 | 51-040445-01 |
| | 211-0008-00 | B021588 | | 4 | SCREW,MACHINE:4-40 X 0.25,PNH,STL | 93907 | ORDER BY DESCR |
| -179 | 211-0260-00 | | | 2 | SCR,ASSEM WSHR:2-56 X 0.687,PNH,STL,POZ (END ATTACHING PARTS) CKT BOARD ASSY INCLUDES: | 01536 | ORDER BY DESCR |
| -180 | 214-2543-00 | | | 1 | .HT SK,MICROCKT:MICROCIRCUIT,AL (ATTACHING PARTS) | 80009 | 214-2543-00 |
| -181 | 211-0259-00 | | | 2 | .SCR,ASSEM WSHR:2-56 X 0.437,PNH,STL,POZ (END ATTACHING PARTS) | 01536 | 4821-00021 |
| -182 | 131-2033-00 | | | 2 | .CONTACT,ELEC:SINGLE,BOTTOM,CU BE (ATTACHING PARTS) | 80009 | 131-2033-00 |
| -183 | 210-0629-00 | | | 4 | .EYELET,METALLIC:0.059 OD X 0.093 L,BRS (END ATTACHING PARTS) | 80009 | 210-0629-00 |
| -184 | 131-2032-00 | | | 2 | .CONTACT,ELEC:SINGLE,TOP,CU BE | 80009 | 131-2032-00 |
| -185 | 426-1351-00 | | | 1 | .FRAME,MICROCKT:1.75 CM | 80009 | 426-1351-00 |
| -186 | 131-1967-01 | | | 1 | .CONT SET,ELEC:MICROCKT,1.75 CM,RUBBER | 80009 | 131-1967-01 |
| -187 | 131-2022-00 | | | 2 | .CONTACT,ELEC:DUAL,BOTTOM,CU BE (ATTACHING PARTS) | 80009 | 131-2022-00 |
| -188 | 210-0629-00 | | | 6 | .EYELET,METALLIC:0.059 OD X 0.093 L,BRS (END ATTACHING PARTS) | 80009 | 210-0629-00 |
| -189 | 131-2020-00 | | | 2 | .CONTACT,ELEC:DUAL,TOP,BERYLLIUM COPPER | 80009 | 131-2020-00 |
| -190 | 136-0252-00 | | | 6 | .SOCKET,PIN TERM:U/W 0.018 DIA PINS | 00779 | 2-330808-7 |
| -191 | 388-5349-01 | | | 1 | .CIRCUIT BOARD:HF VERTICAL CHANNEL SWITCH (ATTACHING PARTS) | 80009 | 388-5349-01 |
| -192 | 210-0702-00 | | | 15 | .EYELET,METALLIC:0.047 OD X 0.125 L (END ATTACHING PARTS) | 07707 | S-6127 |
| -193 | 214-0668-00 | | | 1 | .HEAT SINK,XSTR:TO-5,AL BLK ANDZ (FOR Q676) | 13103 | 22118 |
| -194 | 441-1378-01 | | | 1 | CHASSIS,CHAN SW: (ATTACHING PARTS) | 80009 | 441-1378-01 |
| -195 | 211-0008-00 | | | 2 | SCREW,MACHINE:4-40 X 0.25,PNH,STL (END ATTACHING PARTS) | 93907 | ORDER BY DESCR |
| -196 | 343-0213-00 | | | 3 | CLAMP,CABLE:0.2 ID,PLASTIC | 80009 | 343-0213-00 |
| -197 | 333-2320-00 | | | 1 | PANEL,REAR: (ATTACHING PARTS) | 80009 | 333-2320-00 |
| -198 | 211-0507-00 | | | 2 | SCREW,MACHINE:6-32 X 0.312,PNH,STL (END ATTACHING PARTS) | 83385 | ORDER BY DESCR |
| -199 | 426-0807-02 | | | 1 | FRAME PNL,CAB.:REAR (ATTACHING PARTS) | 80009 | 426-0807-02 |
| -200 | 213-0270-00 | | | 4 | SCR,TPG,TF:10-32 X 0.75,SPCL TYPE,FILH,STL (END ATTACHING PARTS) | TK1543 | 234-74658-026 |
| -201 | 200-0678-00 | B010115 | | 9 | COVER,ELEC CONN:BNC,NON-SHORTING (OPTION 03 ONLY) | 91836 | KC89-58TR5 |
| -202 | 346-0045-00 | B010115 | | 9 | STRAP,CONN COV:BNC ONE END,POLYPROPYLENE (OPTION 03 ONLY) | 80009 | 346-0045-00 |

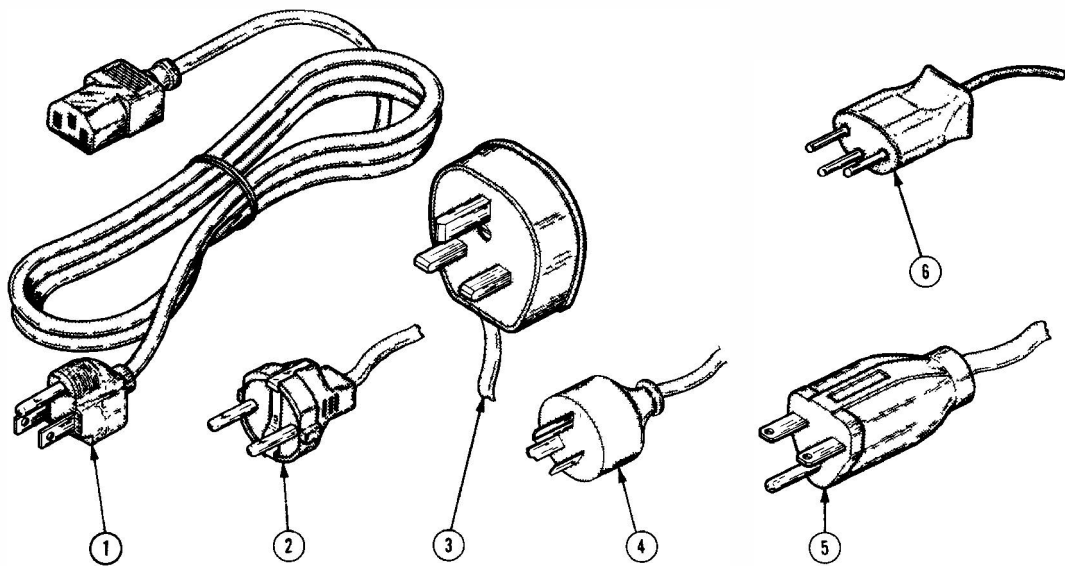

REV MAR 1984

7904A OSCILLOSCOPE

| Fig. & Index No. | Tektronix Part No. | Serial/Assembly No. Effective | Dscort | Qty | 12345 Name & Description | Mfr. Code | Mfr. Part No. |
|------------------|--------------------|-------------------------------|--------|-----|---|-----------|----------------|
| 6- | | | | | STANDARD ACCESSORIES | | |
| -1 | 161-0066-00 | | | 1 | CABLE ASSY,PWR, :3,18AWG,115V,98.0 L | 16428 | CH8481, FH8481 |
| -2 | 161-0066-09 | | | 1 | CABLE ASSY,PWR, :3,0.75MM SQ,220V,99.0 L (OPTION A1 ONLY) | S3109 | 86511000 |
| -3 | 161-0066-10 | | | 1 | CABLE ASSY,PWR, :3,0.75MM SQ,240V,96.0 L (OPTION A2 ONLY) | TK1373 | 24230 |
| -4 | 161-0066-11 | | | 1 | CABLE ASSY,PWR, :3,0.75MM,240V,96.0 L (OPTION A3 ONLY) | S3109 | ORDER BY DESCR |
| -5 | 161-0066-12 | | | 1 | CABLE ASSY,PWR, :3,18 AWG,250V,99.0 L (OPTION A4 ONLY) | 70903 | CH-77893 |
| -6 | 161-0154-00 | | | 1 | CABLE ASSY,PWR, :3,0.75MM SQ,240V,6A,2.5M L (OPTION A5 ONLY) | S3109 | 86515000 |
| | 070-4593-00 | | | 1 | MANUAL,TECH: INSTR,7904A | 80009 | 070-4593-00 |
| | | | | | OPTIONAL ACCESSORIES | | |
| | 012-0341-00 | | | 1 | CA ASSY,CUR P:12.0 | 80009 | 012-0341-00 |

MANUAL CHANGE INFORMATION

At Tektronix, we continually strive to keep up with latest electronic developments by adding circuit and component improvements to our instruments as soon as they are developed and tested.

Sometimes, due to printing and shipping requirements, we can't get these changes immediately into printed manuals. Hence, your manual may contain new change information on following pages.

A single change may affect several sections. Since the change information sheets are carried in the manual until all changes are permanently entered, some duplication may occur. If no such change pages appear following this page, your manual is correct as printed.

Date: 5/6/88 Change Reference: C110/0588 Rev 2

Manual Part No.: see product

Product: All 7000 Service manuals

Product Group: 42

DESCRIPTION

Effective for all serial numbers.

Revised 9/26/88
Revised 10/13/88

REPLACEABLE ELECTRICAL PARTS LIST CHANGES

The part number has changed for a transistor which may be used in your 7000-Series product. Part number 151-0220-00 has changed to 151-0220-07. Use the new 151-0220-07 part number when ordering a replacement for transistors listed as 151-0220-00 in your Replaceable Electrical Parts List.

Most berg sockets, part number 136-0252-07, have been removed from this 7000-Series instrument to facilitate assembly and improve reliability.

DESCRIPTION Manual Insert for Product Group 42

Revised 1/2/89

These changes are effective at serial number B040000.

The following changes to the 7904A Instruction Manual result from the utilization of a different ventilating fan in the 7904A Oscilloscope.

REPLACEABLE ELECTRICAL PARTS LIST CHANGES

REMOVE:

| | | |
|---------|-------------|--|
| A11 | 670-4641-00 | CKT BOARD ASSY:FAN |
| A11B20 | 147-0035-00 | MOTOR,DC:BRUSHLESS,10-15VDC,145MA |
| A11C10 | 290-0778-00 | CAP.,FXD,ELCTLT:1UF,+50-10%,50V |
| A11C13 | 290-0768-00 | CAP.,FXD,ELCTLT:10UF,+50-10%,100V |
| A11CR10 | 152-0141-02 | SEMICON DVC,DI:SW,SI,30V,150MA,30V,DO-35 |
| A11CR13 | 152-0141-02 | SEMICON DVC,DI:SW,SI,30V,150MA,30V,DO-35 |
| A11CR21 | 152-0141-02 | SEMICON DVC,DI:SW,SI,30V,150MA,30V,DO-35 |
| A11CR22 | 152-0141-02 | SEMICON DVC,DI:SW,SI,30V,150MA,30V,DO-35 |
| A11CR23 | 152-0141-02 | SEMICON DVC,DI:SW,SI,30V,150MA,30V,DO-35 |
| A11CR24 | 152-0141-02 | SEMICON DVC,DI:SW,SI,30V,150MA,30V,DO-35 |
| A11P80 | 131-0608-00 | TERMINAL,PIN:0.365 L X 0.025 PH BRZ GOLD |
| A11P80 | — — | (QUANTITY OF 2) |
| A11Q10 | 151-0301-00 | TRANSISTOR:SILICON,PNP |
| A11Q20 | 156-0281-00 | MICROCIRCUIT,LI:4 TRANSISTOR ARRAY |
| A11R10 | 301-0271-00 | RES.,FXD,CMPSN:270 OHM,5%,0.5W |
| A11R11 | 315-0470-00 | RES.,FXD,CMPSN:47 OHM,5%,0.25W |
| A11R13 | 301-0271-00 | RES.,FXD,CMPSN:270 OHM,5%,0.5W |
| A11R20 | 307-0059-00 | RES.,FXD,CMPSN:6.2 OHM,5%,0.50W |
| A11R24 | 321-0201-00 | RES.,FXD,FILM:1.21K OHM,1%,0.125W |
| A11R25 | 321-0239-00 | RES.,FXD,FILM:3.01K OHM,1%,0.125W |
| A11R27 | 321-0022-00 | RES.,FXD,FILM:16.5 OHM,1%,0.125W |

ADD:

| | | |
|-----|-------------|-----------------------------------|
| B20 | 119-1545-01 | FAN,TUBEAXIAL:12V,4.8W,RPM,35 CFM |
| R20 | 308-0175-00 | RES.,FXD,WW:10 OHM,5%,10W |

REPLACEABLE MECHANICAL PARTS LIST CHANGES**REMOVE:**

| | | | |
|------------|-------------|---|--|
| Fig. 3-91 | 369-0035-00 | 1 | IMPLR,FAN AXIAL:PLASTIC |
| Fig. 3-92 | 407-1874-01 | 1 | BRACKET,ANGLE:FAN |
| Fig. 3-93 | 211-0504-00 | 1 | SCREW,MACHINE:6-32 X 0.250,PNH,STL,CD PL |
| Fig. 3-94 | 343-0411-00 | 2 | STRAP,RETAINING:2.494 X 0.8,STL TIN PL |
| Fig. 3-95 | 211-0510-00 | 2 | SCREW,MACHINE:6-32 X 0.375,PNH,STL,CD PL |
| Fig. 3-96 | 210-0457-00 | 2 | NUT,ASSEM WA:6-32 X 0.312,STL,CD PL |
| Fig. 3-97 | — — | - | CKT BOARD ASSY:(SEE A11 REPL) |
| Fig. 3-98 | 211-0504-00 | 1 | SCREW,MACHINE:6-32 X 0.250,PNH,STL |
| Fig. 3-121 | 121-0669-00 | 1 | .SPACER,POST:2.03 L,6-32 THD BOTH ENDS,AL,0.25 DIA |
| | 175-2854-00 | 1 | CA ASSY,SP,ELEC:2,26 AWG,5.0 L |

ADD:

| | | | |
|--|-------------|---|--|
| | 119-1545-01 | 1 | FAN,TUBEAXIAL:(SEE B20 REPL) |
| | 174-0084-00 | 1 | CA ASSY,SP,ELEC:2,26 AWG,8.0 L,RIBBON |
| | 210-0202-00 | 1 | TERMINAL,LUG:0.146 ID,LOCKING,BRZ,TIN PL |
| | 210-0457-00 | 4 | NUT,PL,ASSEM WA:6-32 X 0.312,STL,CD PL |
| | 210-0478-00 | 1 | SPACER,POST:0.66 L W/6-32 THD THRU,AL |
| | 210-0601-00 | 1 | EYELET,METALLIC:0.183 OD X 0.192 L,BRASS |
| | 211-0510-00 | 1 | SCREW,MACHINE:6-32 X 0.375,PNH,STL,CD PL |
| | 211-0513-00 | 4 | SCREW,MACHINE:6-32 X 0.625,PNH,STL,CD PL |
| | 211-0553-00 | 1 | SCREW,MACHINE:6-32 X 1.5,PNH,STL,CD PL |
| | 308-0175-00 | 1 | RESISTOR:(SEE R20 REPL) |
| | 378-0279-00 | 1 | GRILL,FAN:3.125 DIA SQ |

CHANGE TO:

| | | | |
|-----------|------------------------|---|--|
| Fig. 1-18 | 390-0603-00 | 1 | CAB SIDE,SCOPE:RIGHT |
| | 390-0604-00 | 1 | CAB SIDE,SCOPE:RIGHT,EMI (OPTION 03 ONLY) |
| Fig. 2-67 | 386-2125-02 | 1 | PANEL,REAR:7904A |

Date: 3/13/87 Change Reference: M61712

Product: 7904A Manual Part No.: 070-4593-00

DESCRIPTION PG.42

THESE CHANGES ARE EFFECTIVE AT SERIAL NUMBER B042166

MECHANICAL PARTS LIST

CHANGE TO:

FIG. 3- 378-2049-00 GRILL,FAN:3.07 DIA.

THE ABOVE INFORMATION MAY NOT BE INCORPORATED INTO YOUR MANUAL. IF NOT, PLEASE NOTE CHANGE REFERENCE: M56709(REV). THE FAN WAS ADDED AS PART NO. 378-0279-00, WHICH HAS BEEN CHANGED TO 378-2049-00. ALSO, THIS IS A DIRECT REPLACEMENT PART (TO ENSURE THE CUSTOMER RECEIVES THE CORRECT REPLACEMENT).

Date: 5-2-89 Change Reference: M67907

Product: 7904A Service

Manual Part No.: 070-4593-00

Product Group: 42

DESCRIPTION

These changes are effective at serial number B042755

REPLACEABLE ELECTRICAL PARTS

CHANGE TO:

| | | |
|---------|-------------|--------------------------------|
| A21Q166 | 151-0434-00 | TRANSISTOR:PNP,SI,TO-72 2N4261 |
| A21Q167 | 151-0434-00 | TRANSISTOR:PNP,SI,TO-72 2N4261 |
| A21Q173 | 151-0270-00 | TRANSISTOR:PNP,SI,TO-39 2N3495 |
| A28Q621 | 151-0434-00 | TRANSISTOR:PNP,SI,TO-72 2N4261 |
| A28Q920 | 151-0270-00 | TRANSISTOR:PNP,SI,TO-39 2N3495 |
| A28Q930 | 151-0270-00 | TRANSISTOR:PNP,SI,TO-39 2N3495 |

Date: 6-SEP-89 Change Reference: M69819

Product: 7904A Service

Manual Part No.: 070-4593-00

Product Group: 42

DESCRIPTION

These changes are effective at serial number B042900

ELECTRICAL PARTS LIST CHANGES

CHANGE TO:

| | | |
|---------|-------------|---|
| A29 | 670 8059-01 | Ckt Board Assy: Horizontal Interconnect |
| A29U518 | 234-0408-20 | Integrated Ckt: Channel Switch |
| A29R603 | 321-0072-00 | Res,Fxd,Film: 54.9 OHM, 1%, 0.125W |
| A29R604 | 321-0072-00 | Res,Fxd,Film: 54.9 OHM, 1%, 0.125W |
| A29R620 | 321-0072-00 | Res,Fxd,Film: 54.9 OHM, 1%, 0.125W |
| A29R622 | 321-0072-00 | Res,Fxd,Film: 54.9 OHM, 1%, 0.125W |

Product: See Below

Manual Part No.: See below

Product Group: 42

DESCRIPTION

These changes are effective for the following Instruments:

Revised 4-Feb-1991

- 070-5039-00, User Manual.
R7103, serial number B061115 & above.
- 070-2314-00, User Manual.
7104, serial number B074550 & above.
- 070-1260-00, User Manual.
7704A, serial number B252526 & above.
- 070-2874-01, User Manual.
7854A, serial number B115936 and above.
- 070-4593-00, User Manual.
7904A, serial number B042930 and above.
- 070-5880-00, User Manual.
7934, serial number B021175 and above.

REPLACEABLE PARTS LIST

REMOVE:

| Ckt No. | Part Number | Description |
|--------------|-------------|----------------------------------|
| R7103 | | |
| A23A1CR33 | 152-0400-00 | Semicond DVC, DI: Rect, SI, 400V |
| A23A1CR34 | 152-0400-00 | Semicond DVC, DI: Rect, SI, 400V |
| A23A1CR39 | 152-0400-00 | Semicond DVC, DI: Rect, SI, 400V |
| A23A1CR40 | 152-0400-00 | Semicond DVC, DI: Rect, SI, 400V |
| 7104 | | |
| CR1233 | 152-0400-00 | Semicond DVC, DI: Rect, SI, 400V |
| CR1234 | 152-0400-00 | Semicond DVC, DI: Rect, SI, 400V |
| CR1239 | 152-0400-00 | Semicond DVC, DI: Rect, SI, 400V |
| CR1241 | 152-0400-00 | Semicond DVC, DI: Rect, SI, 400V |
| 7704A | | |
| A30CR33 | 152-0400-00 | Semicond DVC, DI: Rect, SI, 400V |
| A30CR34 | 152-0400-00 | Semicond DVC, DI: Rect, SI, 400V |
| A30CR39 | 152-0400-00 | Semicond DVC, DI: Rect, SI, 400V |
| A30CR41 | 152-0400-00 | Semicond DVC, DI: Rect, SI, 400V |
| 7854 | | |
| A30CR33 | 152-0400-00 | Semicond DVC, DI: Rect, SI, 400V |
| A30CR34 | 152-0400-00 | Semicond DVC, DI: Rect, SI, 400V |
| A30CR39 | 152-0400-00 | Semicond DVC, DI: Rect, SI, 400V |
| A30CR41 | 152-0400-00 | Semicond DVC, DI: Rect, SI, 400V |

Revised 4-Feb-1991

7904A

| | | |
|---------|-------------|----------------------------------|
| A30CR33 | 152-0400-00 | Semicond DVC, DI: Rect, SI, 400V |
| A30CR34 | 152-0400-00 | Semicond DVC, DI: Rect, SI, 400V |
| A30CR39 | 152-0400-00 | Semicond DVC, DI: Rect, SI, 400V |
| A30CR41 | 152-0400-00 | Semicond DVC, DI: Rect, SI, 400V |

7934

| | | |
|-----------|-------------|----------------------------------|
| A14A3CR33 | 152-0400-00 | Semicond DVC, DI: Rect, SI, 400V |
| A14A3CR34 | 152-0400-00 | Semicond DVC, DI: Rect, SI, 400V |
| A14A3CR39 | 152-0400-00 | Semicond DVC, DI: Rect, SI, 400V |
| A14A3CR41 | 152-0400-00 | Semicond DVC, DI: Rect, SI, 400V |

ADD:

Ckt No.

Part Number

Description

R7103

| | | |
|-----------|-------------|--------------------------------------|
| A23A1CR33 | 152-0886-00 | Semicond DVC, DI: Rect, SI, 1A, 600V |
| A23A1CR34 | 152-0886-00 | Semicond DVC, DI: Rect, SI, 1A, 600V |
| A23A1CR39 | 152-0886-00 | Semicond DVC, DI: Rect, SI, 1A, 600V |
| A23A1CR40 | 152-0886-00 | Semicond DVC, DI: Rect, SI, 1A, 600V |

7104

| | | |
|--------|-------------|--------------------------------------|
| CR1233 | 152-0886-00 | Semicond DVC, DI: Rect, SI, 1A, 600V |
| CR1234 | 152-0886-00 | Semicond DVC, DI: Rect, SI, 1A, 600V |
| CR1239 | 152-0886-00 | Semicond DVC, DI: Rect, SI, 1A, 600V |
| CR1241 | 152-0886-00 | Semicond DVC, DI: Rect, SI, 1A, 600V |

7704A

| | | |
|---------|-------------|--------------------------------------|
| A30CR33 | 152-0886-00 | Semicond DVC, DI: Rect, SI, 1A, 600V |
| A30CR34 | 152-0886-00 | Semicond DVC, DI: Rect, SI, 1A, 600V |
| A30CR39 | 152-0886-00 | Semicond DVC, DI: Rect, SI, 1A, 600V |
| A30CR41 | 152-0886-00 | Semicond DVC, DI: Rect, SI, 1A, 600V |

7854

| | | |
|---------|-------------|--------------------------------------|
| A30CR33 | 152-0886-00 | Semicond DVC, DI: Rect, SI, 1A, 600V |
| A30CR34 | 152-0886-00 | Semicond DVC, DI: Rect, SI, 1A, 600V |
| A30CR39 | 152-0886-00 | Semicond DVC, DI: Rect, SI, 1A, 600V |
| A30CR41 | 152-0886-00 | Semicond DVC, DI: Rect, SI, 1A, 600V |

7904A

| | | |
|---------|-------------|--------------------------------------|
| A30CR33 | 152-0886-00 | Semicond DVC, DI: Rect, SI, 1A, 600V |
| A30CR34 | 152-0886-00 | Semicond DVC, DI: Rect, SI, 1A, 600V |
| A30CR39 | 152-0886-00 | Semicond DVC, DI: Rect, SI, 1A, 600V |
| A30CR41 | 152-0886-00 | Semicond DVC, DI: Rect, SI, 1A, 600V |

7934

| | | |
|-----------|-------------|--------------------------------------|
| A14A3CR33 | 152-0886-00 | Semicond DVC, DI: Rect, SI, 1A, 600V |
| A14A3CR34 | 152-0886-00 | Semicond DVC, DI: Rect, SI, 1A, 600V |
| A14A3CR39 | 152-0886-00 | Semicond DVC, DI: Rect, SI, 1A, 600V |
| A14A3CR41 | 152-0886-00 | Semicond DVC, DI: Rect, SI, 1A, 600V |

DESCRIPTION

Product Group 42

EFFECTIVE FOR SERIAL NUMBERS B053061 AND ABOVE

Change Replaceable Electrical Parts to:

| | | |
|---------|-------------|---|
| A28 | 670-1632-07 | Ckt bd assy: Horizontal Amp |
| A28R311 | 321-0129-00 | Res, fxd, film: 215 Ω , 1%, 0.125W |
| A28R341 | 321-0129-00 | Res, fxd, film: 215 Ω , 1%, 0.125W |
| A28R221 | 321-0143-00 | Res, fxd, film: 301 Ω , 1%, 0.125W |

The following description applies to the READOUT system in these 7000-series Instruments:

| | | |
|-------|-------------|------------|
| R7903 | 070-1464-00 | SN B223044 |
| R7844 | 070-1676-02 | SN B162108 |
| 7104 | 070-2314-00 | SN B084600 |
| 7904A | 070-4593-00 | SN B052989 |

This version of the Readout System replaces previous versions. Therefore general information on its operation and an explanation of the terms used, can be found in the circuit description of the older versions in the manual. The detailed schematic diagrams can be found at the end of this insert.

The Readout System provides an alphanumeric display of information encoded by the plug-in units. This display is presented on the CRT and is written on a time shared basis with the analog waveform. Because of this CRT time-sharing, the readout system is a relative independent building block within the oscilloscope. It is built around a microcontroller which generates the various control signals and processes the input data. The other circuit blocks are providing an interface between the oscilloscope and the microcontroller.

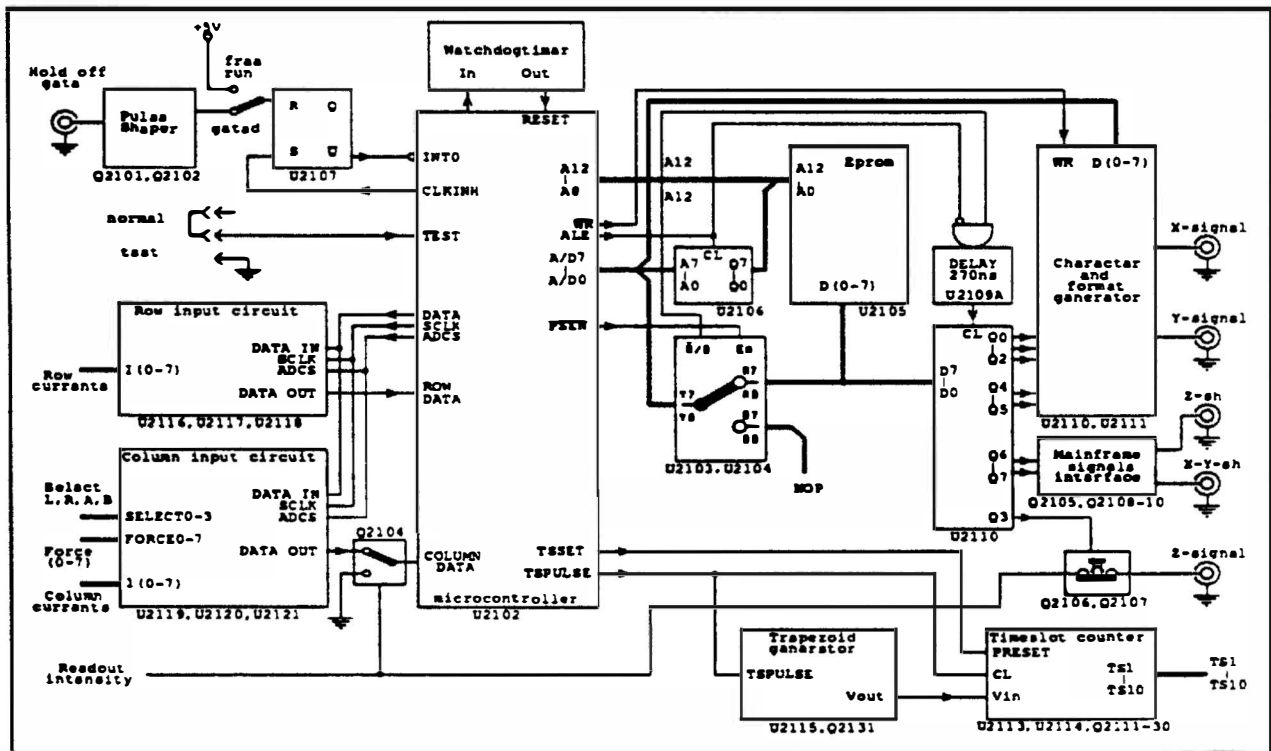

Fig. 1 Block diagram of the Readout System

MICRO CONTROLLER CIRCUIT AND WATCHDOG TIMER

Microcontroller circuit

To generate the various control signals and processing the input data, a micro controller is used. The micro controller is able to operate in two different modes:

1. As a controller.

Address bit 12 is low and the micro controller generates signals for the readout. This is the normal mode of operation.

2. As an address generator .

Address bit 12 is high and the micro controller is only performing NOP's. As a result of this, at a clock frequency of 12 MHz, new data from the EPROM is sent to the datalatch of the character generator every micro second. This mode is only used when writing a character and is terminated by a timer interrupt (of timer 1).

During timeslot n the micro controller executes the following tasks:

1. Start the falling edge of the timeslot trapezoid and clock the timeslot counter. If timeslot 9 is reached, the timeslot counter is synchronized.
2. Retrigger the watchdog timer.
3. Check that the test switch (P2184) is still in position "normal".
4. Start the A/D conversion.
5. Write, if necessary, the character of timeslot n-1.
6. Start the rising edge of the timeslot pulse.
7. Read the contents of both A/D converters and at the same time set the multiplexers in the correct position to measure the row and column currents of timeslot n+1.
8. Calculate the character that should be displayed during timeslot n+1.

The timing relations of the most significant signals are shown on page 3.

The overall timing is controlled by an internal timer of the micro controller, not by the number of instructions executed.

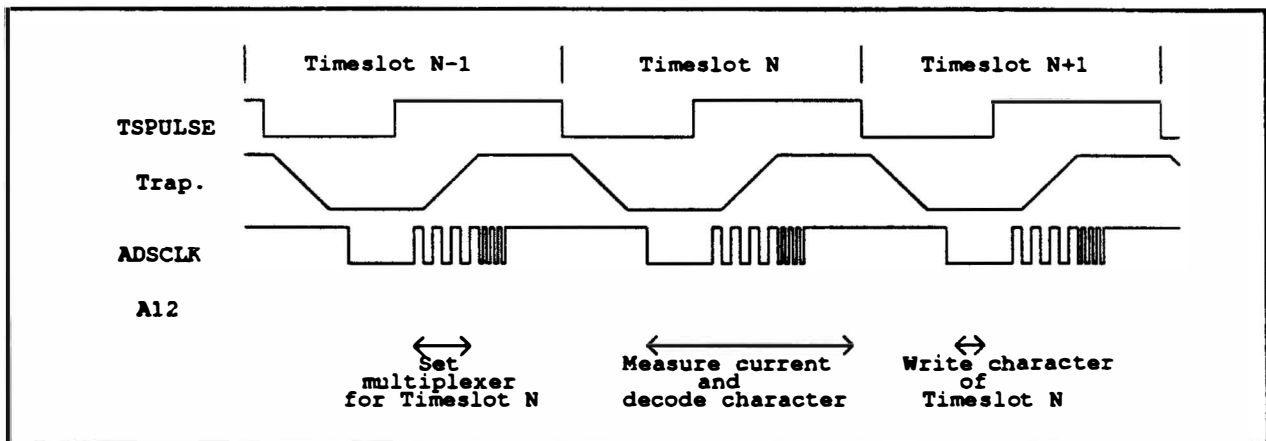

Fig. 2 Timing relations of important signals

Test mode

Some sort of self testing is provided by setting jumper P2184 in position "test". The controller will test both the A/D converters, using the internal test voltage on input 12. If a value other than 80H is returned, an error message will be displayed. If both the converters operate correctly, two rows of 40 zeros are displayed on the screen.

If P2184 is set to "normal" again, the controller will enter the idle mode for 800us. If this mode is not interrupted by a reset of the watchdog timer, another error message is displayed.

Watchdog timer

The timer (U2101) operates as an astable multivibrator. The output (Q) is high during 30us and low during 300us. The circuit associated with Q2103 can interrupt this process. A negative going pulse (5us) opens Q2103 for a moment and C2118 is recharged. If this pulse is missing, C2118 will discharge to $V_{thr} = (1/3) \cdot 5V$. Then the output is going high for about 30us while C2118 is recharged through R2101 and D2101 to $V_{tr} = (2/3) \cdot 5V$ and output Q is going low again. The microcontroller will be reset by this output pulse.

INPUT CIRCUIT AND A/D CONVERTER

Circuit for row decoding

The inputs circuit convert 8 input currents, in the range of 0.0 mA to 1.3 mA, to a 4 bits number code. For correct operation of the read-out, the row and column decoders must maintain ground level at their inputs. The input circuits around U2116 and U2117 provide a virtual ground at the input of the row decoding circuit and also perform the current to voltage conversion for the A/D converter. U2118 is a 8-bit sample and hold A/D converter with a 12 channel input multiplexer and serial I/O. The 12th channel is internally connected a self-test voltage of $(V_{ref} - V_{ag})/2$ which provides the output code 80H.

In order to use the full range of the A/D converter, the op-amp has a supply voltage of 6.4V, thereby compensating for the voltage drop across its output stage. The value of the feedback resistors (R2250, R2252 etc.) has been selected to let 0.1 mA correspond to $(1/16) \cdot (V_{ref} - V_{ag})$.

The inputs are protected by diode pairs D2105 thru D2112. The grounding resistors (R2251, R2253 etc.) suppress high frequency interference on the input.

Column decoding circuit

The column decoding circuit is somewhat different from the row decoding circuit. It has to support two additional inputs:

- select (A horizontal, B horizontal, L vertical or R vertical)
- force readout (A horizontal channel 1, A horizontal channel 2 etc.)

The select input is normally floating. If a plug-in hole in the mainframe is not selected, it's select input is connected to +5V and the readout circuit disables the readout of that hole. If it is still necessary for the plug-in to keep the information on the screen, the force-readout input (normally floating) is connected to ground.

Because the op-amp is not able to provide a virtual ground for positive input currents, D2121 thru D2135 have been added. In order to keep the input at 0V (+/- 100mV), V_d is used as reference voltage and the values of the feedback resistors (R2291, R2293 etc.) are corrected for the smaller range of the A/D converter.

THE TIMESLOT TRAPEZOID GENERATOR AND COUNTER

The timeslot trapezoid generator

The timeslot trapezoid generator and the timeslot counter generate 10 negative going trapezoid pulses, which meet the following specifications:

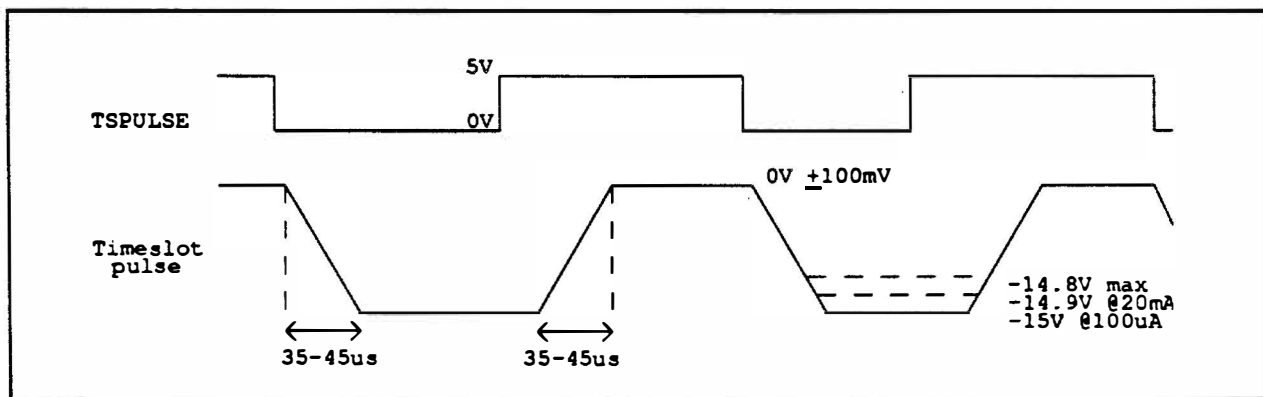

Fig. 3 The timeslot trapezoid

The timeslot trapezoid is generated by the circuitry around U2115. It is configured by integrating TS PULSE. TS PULSE is inverted and DC shifted by U2115B. The resulting pulse is then integrated. The integrator consists of op-amp U2115A with an additional low impedance output stage (Q2131 and R2237) and C2135 as integrating element. The output of the integrator is bounded by the -15V of the power supply and the 0V clamping voltage of diode pair D2104. So the output signal, which would be triangular, becomes a trapezoid.

Timeslot counter

The timeslot counter demultiplexes the timeslot trapezoid into 10 timeslot pulses. It consists of a decade counter and a 1 out of 10 decoder with additional output stages. The decade counter (U2113) is clocked by the falling edge of TS PULSE.

The microcontroller keeps track of the current timeslot. If timeslot 9 is reached, it synchronizes the decade counter by a short positive pulse on TSSET, which presets the decade counter to 9.

The outputs of U2113 are decoded by a 1 out of 10 decoder with open collector outputs (U2114). The outputs are active low. This will turn the corresponding PNP-transistor (Q2111 thru Q2120) on and force the corresponding NPN-transistor (Q2121 thru Q2130) in saturation.

Because of the low impedance output stage of the timeslot pulse generator and this PNP - NPN output stage, it is possible for the bottom of the timeslot pulse to be within 100mV of the -15V supply voltage when the timeslot pulse is loaded with 20mA.

CHARACTER AND FORMAT GENERATOR

Character generator

The characters are written with short vectors. For example, to write an "8", the following signals are needed: (See Fig. 4).

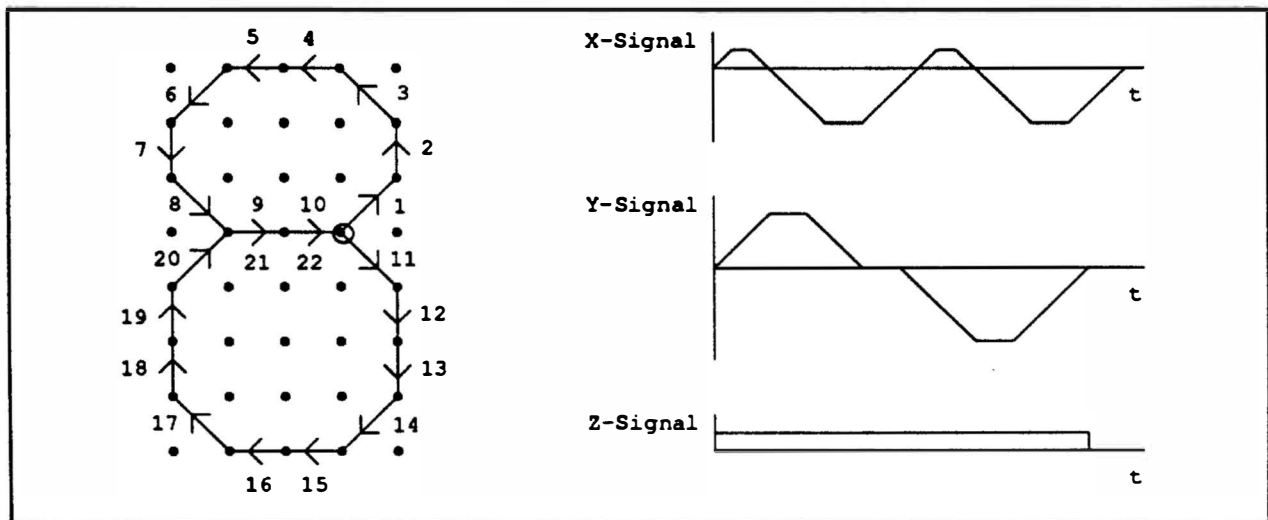

Fig. 4 Signals needed to write an "8"

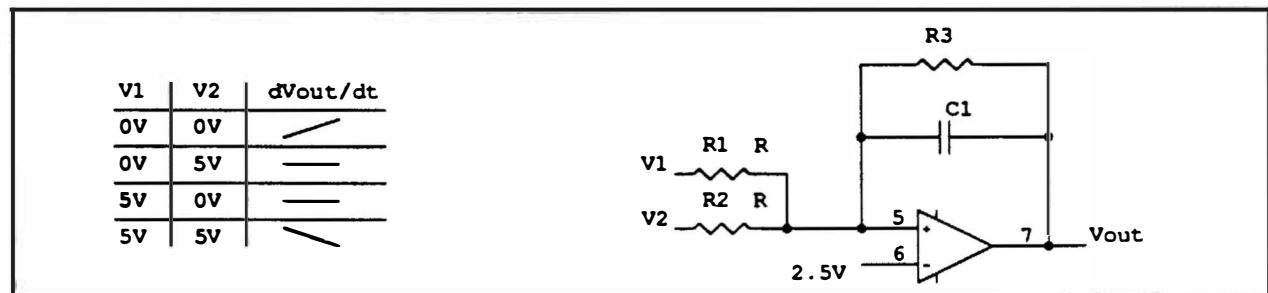

Fig. 5 a) possible codes b) Simple Integrator circuit

By offering the right codes, these signals can be generated with the integrator circuit as shown in Fig. 5. The values of R1, R2 and C1 control the ramp of the output voltages (character size). R3 has been added to limit the drift of the circuit (e.g. caused by offset voltage op-amp, difference R1 and R2, etc.). If this circuit is used for the X- and Y axis, lines can be written between points of an imaginary grid. But this grid is too coarse to make all the characters. If the grid size in the X direction is reduced by two extra medial points it is possible to make all the characters needed by the read out system with 28 vectors.

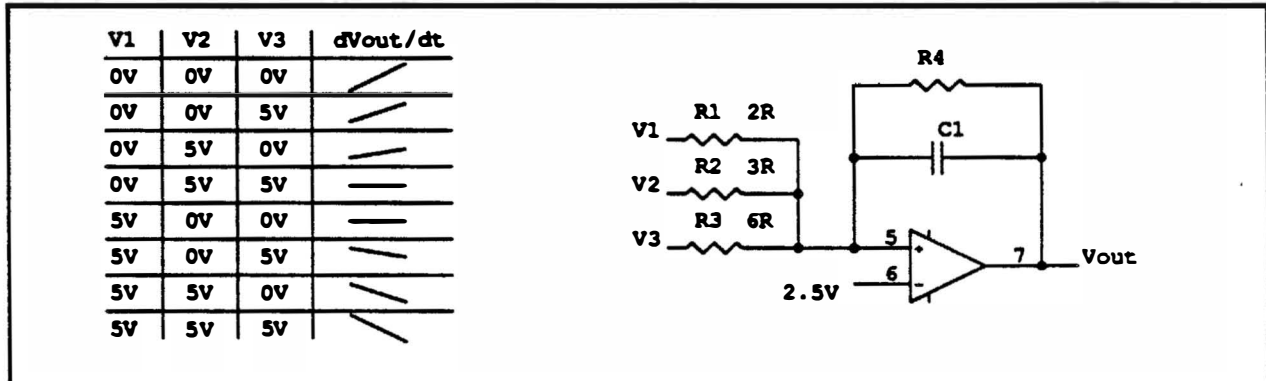

Fig. 6 a) possible codes b) Extended Integrator circuit

A data latch, that receives new data every microsecond, provides data for the Integrator circuits (See Micro Controller chapter). C2130 and C2131 are added to smooth the output signals of the datalatch.

Format generator

The actual position of a character is set by the value of the data word in datalatch U2108. It is calculated by the micro controller and written into this latch. Bits 0 - 4 are used for the character position, bits 5 - 7 are used for the word position. If no character is being written, the X-Y-shutdown signal is used to get U2108 into the tristate mode. This results in an output voltage of 0V on the X- and Y-output if no character is written.

If the MSB of the word position is needed for triggering, this tristate switching can be disabled by connecting TP2102 to ground (TP2101).

| ColumnNumber → ↓ RowNumber | | ColumnNumber | C0 | C1 | C2 | C3 | C4 | C5 | C6 | C7 | C8 | C9 | C10 |
|-------------------------------------|-----|------------------|--------------------------------|--------------------------------|--------------------------------|--------------------------------|--------------------------------|--------------------------------|--------------------------------|--------------------------------|--------------------------------|---------------------------------|------------|
| | | Current (mA) | 0 | 0.1 | 0.2 | 0.3 | 0.4 | 0.5 | 0.6 | 0.7 | 0.8 | 0.9 | >1.0 |
| R-1 | 0 | ↑ SKIP * ↓ | 0 | 1 | 2 | 3 | 4 | 5 | 6 | 7 | 8 | 9 | |
| R-2 | 0.1 | | ↓ | < | I | | + | - | + | C | Δ | > | |
| R-3 | 0.2 | | Add one zero * | Add two zeros * | Reduce one prefix * | Reduce prefix, add zero | | | | | | | Identify * |
| R-4 | 0.3 | | m | μ | n | p | X | K | M | G | T | R | |
| R-5 | 0.4 | | S | V | A | W | H | d | B | c | Ω | E | |
| R-6 | 0.5 | | U | N | L | Z | Y | P | F | J | Q | D | |
| R-7 | 0.6 | | Decimal point location no. 1 * | Decimal point location no. 2 * | Decimal point location no. 3 * | Decimal point location no. 4 * | Decimal point location no. 5 * | Decimal point location no. 6 * | Decimal point location no. 7 * | Decimal point location no. 8 * | Decimal point location no. 9 * | Decimal point location no. 10 * | |
| R-8 | 0.7 | | | | | | | | | | . | | |
| R-9 | 0.8 | | | | | | | | | | | | |
| R-10 | 0.9 | | Add space in display | | | | | | | | | | |
| R-14 | 1.3 | ← JUMP * → | | | | | | | | | | | |

* Operational address



Unused locations. Available for future expansion of the Readout system.

Fig. 7 Character selection matrix

Product: 7000-Series

Date: 3-5-90

Change Reference: M68770

REPLACEABLE ELECTRICAL PARTS LIST CHANGES

REMOVE:

| | | |
|-------|-------------|--|
| A22 | 670-4346-00 | CIRCUIT BOARD ASSY:READOUT PROTECTION #1 (R7903 ONLY) |
| A27 | 670-4346-00 | CIRCUIT BOARD ASSY:READOUT PROTECTION #1 (R7104 AND 7904A ONLY) |
| A32 | 670-4346-00 | CIRCUIT BOARD ASSY:READOUT PROTECTION #1 (R7844 ONLY) |
| A15 | 670-8620-07 | CIRCUIT BOARD ASSY:READOUT (7104 ONLY) |
| A15A1 | 670-8620-07 | CIRCUIT BOARD ASSY:READOUT (7904A ONLY) |
| A21 | 670-8620-07 | CIRCUIT BOARD ASSY:READOUT (7903 ONLY) |
| A26 | 670-8620-07 | CIRCUIT BOARD ASSY:READOUT (7804 ONLY) |

ADD:

| | | |
|--|-------------|----------------------------|
| | 671-1342-02 | CIRCUIT BOARD ASSY:READOUT |
|--|-------------|----------------------------|

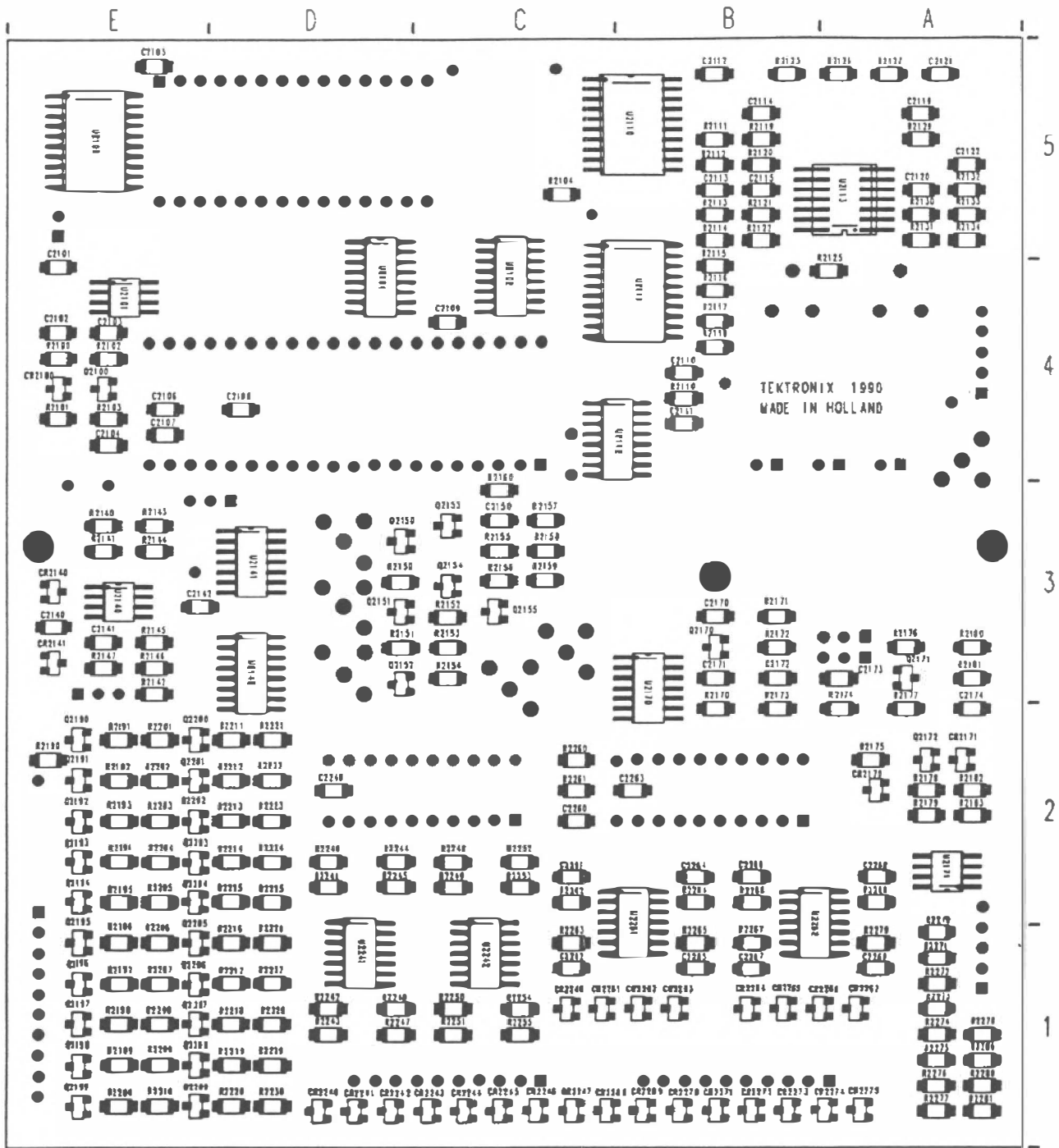

Fig. 8b. Readout Circuit Board (bottom side)

7000 Series

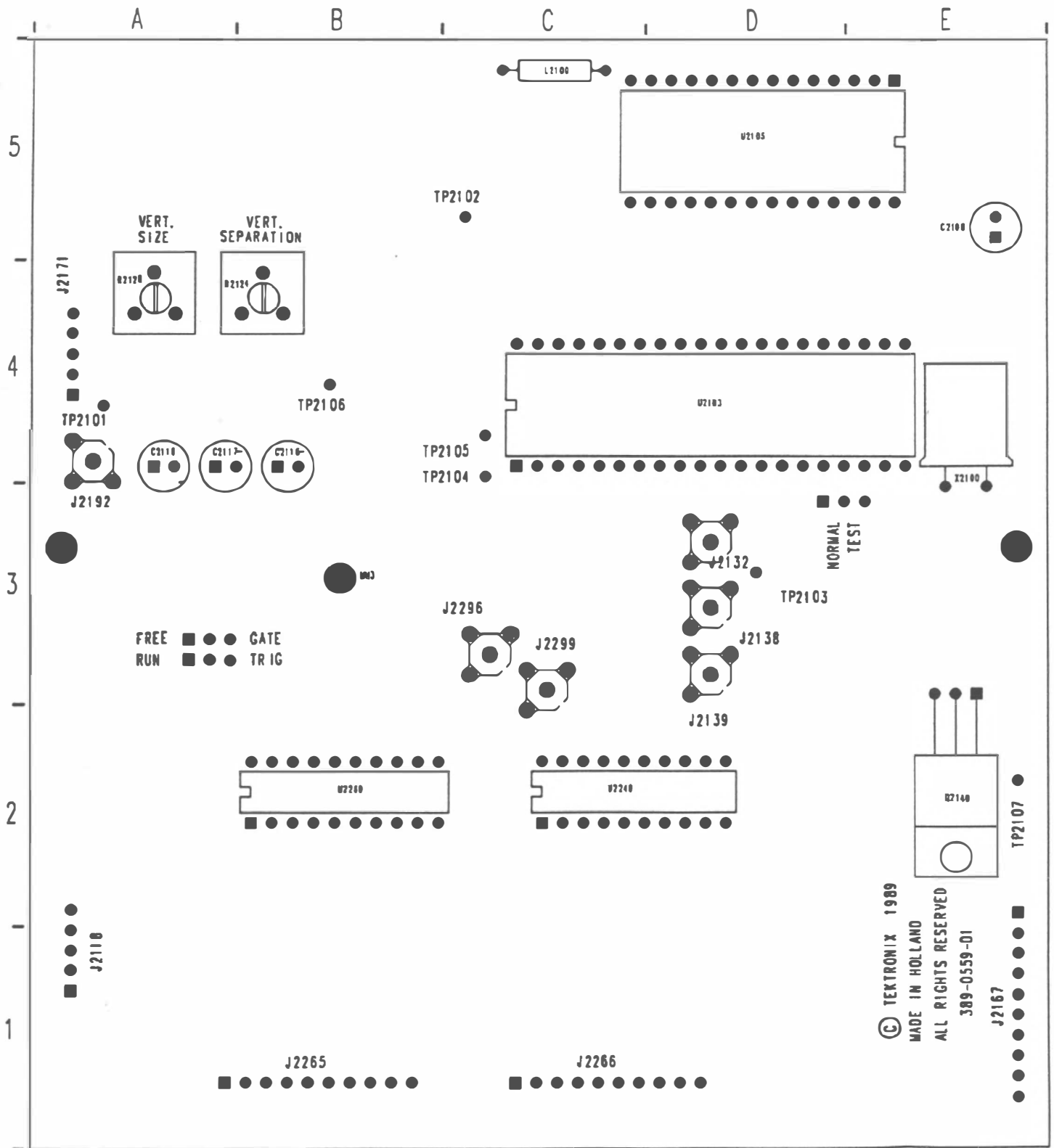
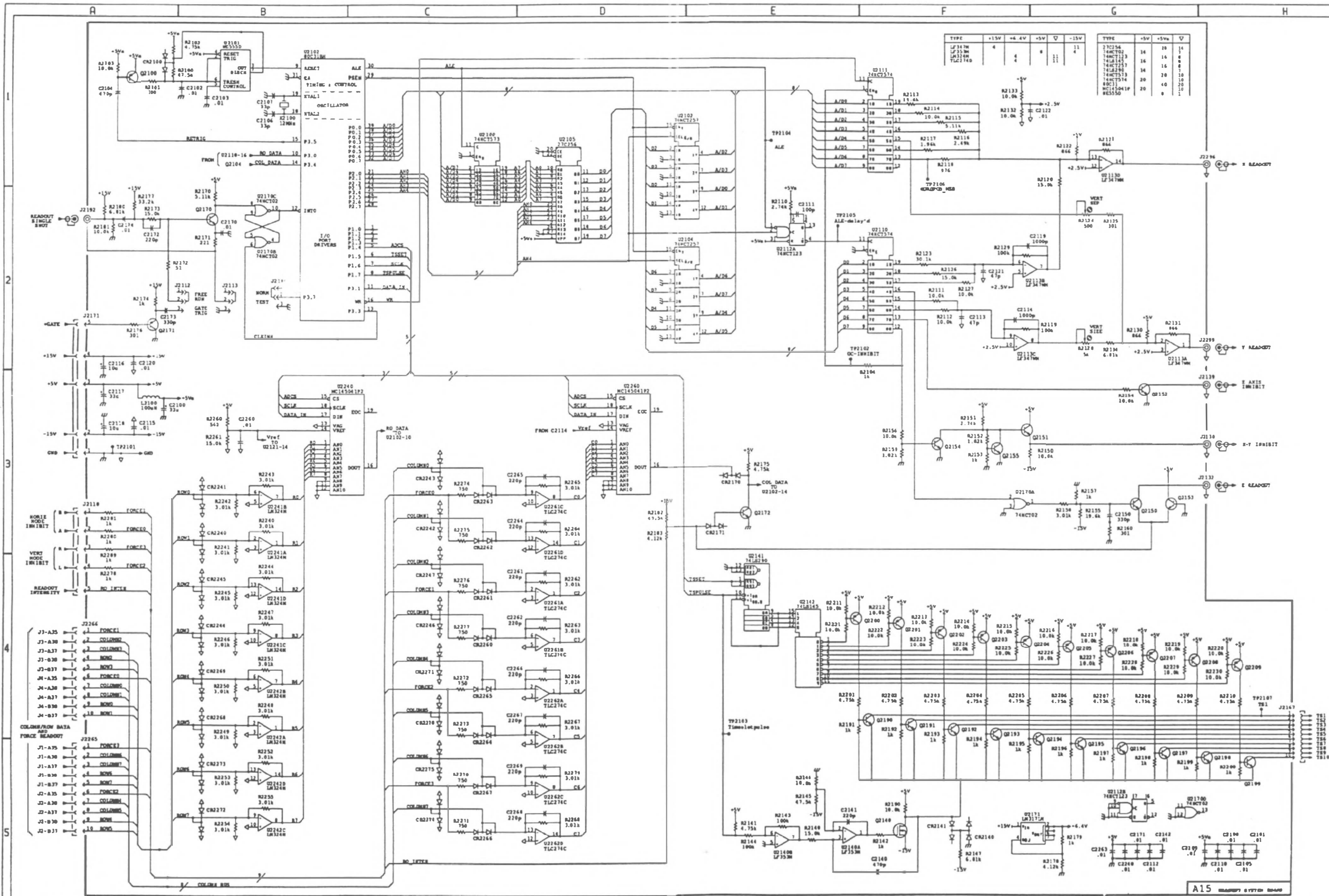

Fig. 8a. Readout Circuit Board (top-side)

| | | | | | | | | | |
|--------|----|-------|----|-------|----|-------|----|--------|----|
| CR2100 | A1 | C2261 | D4 | R2111 | F2 | R2196 | G5 | R2196 | G5 |
| CR2140 | F5 | C2262 | D4 | R2112 | F2 | R2197 | G5 | R2273 | C4 |
| CR2141 | F5 | C2263 | G5 | R2113 | F1 | R2198 | G5 | R2274 | C3 |
| CR2170 | E3 | C2264 | D3 | R2114 | F1 | R2199 | G5 | R2275 | C3 |
| CR2171 | E3 | C2265 | D3 | R2115 | F1 | R2200 | H5 | R2276 | C4 |
| CR2240 | B3 | C2266 | D4 | R2116 | F1 | R2201 | E4 | R2277 | C4 |
| CR2241 | B3 | C2266 | C5 | R2117 | F1 | R2202 | F4 | R2278 | A4 |
| CR2242 | C3 | C2267 | D4 | R2118 | F1 | R2203 | F4 | R2279 | D5 |
| CR2243 | C3 | C2268 | D5 | R2119 | F2 | R2204 | F4 | R2280 | A3 |
| CR2244 | B4 | C2269 | D5 | R2120 | G1 | R2205 | F4 | R2281 | A3 |
| CR2245 | B4 | J2112 | B2 | R2121 | G1 | R2206 | G4 | R2289 | A3 |
| CR2246 | C4 | J2113 | B2 | R2122 | G1 | R2207 | G4 | TP2101 | A3 |
| CR2247 | C4 | J2118 | A3 | R2123 | F2 | R2208 | G4 | TP2102 | E2 |
| CR2260 | C4 | J2132 | H3 | R2124 | G2 | R2209 | G4 | TP2103 | E4 |
| CR2261 | C4 | J2138 | H3 | R2125 | G2 | R2210 | H4 | TP2104 | E1 |
| CR2262 | C3 | J2139 | H3 | R2126 | F2 | R2211 | E4 | TP2105 | E2 |
| CR2263 | C3 | J2167 | H4 | R2127 | F2 | R2212 | F4 | TP2106 | F1 |
| CR2264 | C4 | J2171 | A2 | R2128 | G2 | R2213 | F4 | TP2107 | H4 |
| CR2265 | C4 | J2184 | B2 | R2129 | F2 | R2214 | F4 | U2100 | C1 |
| CR2267 | C5 | J2192 | A2 | R2130 | G2 | R2215 | F4 | U2101 | B1 |
| CR2268 | B4 | J2265 | A5 | R2131 | G2 | R2216 | G4 | U2102 | D1 |
| CR2269 | B4 | J2266 | A4 | R2132 | G1 | R2217 | G4 | U2103 | B1 |
| CR2270 | C4 | J2296 | H1 | R2133 | G1 | R2218 | G4 | U2104 | D2 |
| CR2271 | C4 | J2299 | H2 | R2134 | G2 | R2219 | G4 | U2105 | D1 |
| CR2272 | B5 | L2100 | B3 | R2140 | E5 | R2220 | H4 | U2110 | F2 |
| CR2273 | B5 | Q2100 | A1 | R2141 | E5 | R2221 | E4 | U2111 | F1 |
| CR2274 | C5 | Q2140 | F5 | R2142 | F5 | R2222 | F4 | U2112A | E2 |
| CR2275 | C5 | Q2150 | G3 | R2143 | E5 | R2223 | F4 | U2112B | G5 |
| C2100 | B3 | Q2151 | F3 | R2144 | E5 | R2224 | F4 | U2113A | G2 |
| C2101 | H5 | Q2152 | G3 | R2145 | E5 | R2225 | F4 | U2113B | F2 |
| C2102 | B1 | Q2153 | G3 | R2146 | E5 | R2226 | G4 | U2113C | F2 |
| C2103 | B1 | Q2154 | F3 | R2147 | F5 | R2227 | G4 | U2113D | G1 |
| C2104 | A1 | Q2155 | F3 | R2150 | F3 | R2228 | G4 | U2140A | E5 |
| C2105 | H5 | Q2170 | B2 | R2151 | F3 | R2229 | G4 | U2140B | E5 |
| C2106 | B1 | Q2171 | A2 | R2152 | F3 | R2230 | H4 | U2141 | E4 |
| C2107 | B1 | Q2172 | E3 | R2153 | F3 | R2240 | B3 | U2142 | E4 |
| C2108 | H5 | Q2190 | F4 | R2154 | G3 | R2241 | B3 | U2170A | F3 |
| C2109 | H5 | Q2191 | F4 | R2155 | G3 | R2242 | B3 | U2170B | B2 |
| C2110 | H5 | Q2192 | F4 | R2156 | F3 | R2243 | B3 | U2170C | B2 |
| C2111 | E2 | Q2193 | F4 | R2158 | G3 | R2244 | B4 | U2170D | H5 |
| C2112 | G5 | Q2194 | G4 | R2159 | F3 | R2245 | B4 | U2171 | F5 |
| C2113 | F2 | Q2195 | G4 | R2167 | G3 | R2246 | B4 | U2240 | B3 |
| C2114 | F2 | Q2196 | G5 | R2170 | B2 | R2247 | B4 | U2241A | B3 |
| C2115 | A3 | Q2197 | G5 | R2171 | B2 | R2248 | B4 | U2241B | B3 |
| C2116 | A2 | Q2198 | H5 | R2172 | A2 | R2249 | B4 | U2241C | B4 |
| C2117 | A3 | Q2199 | H5 | R2173 | A2 | R2250 | B4 | U2241D | B4 |
| C2118 | A3 | Q2200 | E4 | R2174 | A2 | R2251 | B4 | U2242A | B4 |
| C2119 | F2 | Q2201 | F4 | R2175 | E3 | R2252 | B5 | U2242B | B4 |
| C2120 | A2 | Q2202 | F4 | R2176 | A2 | R2253 | B5 | U2242C | B5 |
| C2121 | F2 | Q2203 | F4 | R2177 | A2 | R2254 | B5 | U2242D | B5 |
| C2122 | G1 | Q2204 | F4 | R2178 | G5 | R2255 | B5 | U2260 | D3 |
| C2140 | F5 | Q2205 | G4 | R2179 | G5 | R2260 | B3 | U2261A | D4 |
| C2141 | E5 | Q2206 | G4 | R2180 | A2 | R2261 | B3 | U2261B | D4 |
| C2142 | G5 | Q2207 | G4 | R2181 | A2 | R2262 | D4 | U2261C | D3 |
| C2150 | G3 | Q2208 | G4 | R2182 | D3 | R2263 | D4 | U2261D | D3 |
| C2170 | B2 | Q2209 | H4 | R2183 | D3 | R2264 | D3 | U2262A | D4 |
| C2171 | G5 | R2100 | A1 | R2190 | F5 | R2265 | D3 | U2262C | D5 |
| C2172 | A2 | R2101 | A1 | R2191 | E4 | R2266 | D4 | U2262D | D5 |
| C2173 | A2 | R2102 | A1 | R2192 | F4 | R2267 | D4 | X2100 | B1 |
| C2174 | A2 | R2103 | A1 | R2193 | F4 | R2268 | D5 | | |
| C2240 | G5 | R2104 | F2 | R2194 | F5 | R2270 | C5 | | |
| C2260 | B3 | R2110 | E2 | R2195 | F5 | R2271 | C5 | | |

LOCATOR FOR READOUT



| TYPE | +15V | +5V | -5V | -15V | TYPE | +5V | +5V | -5V |
|---------|------|-----|-----|------|-----------|-----|-----|-----|
| LF337M | 4 | 4 | 8 | 11 | 74C254 | 14 | 16 | 14 |
| LF338M | | | | | 74C123 | 16 | 16 | 6 |
| LF339M | | | | | 74164 | 16 | 16 | 0 |
| 74C114B | | | | | 74C275 | 14 | 16 | 0 |
| | | | | | 74165 | 16 | 16 | 0 |
| | | | | | 74C753 | 14 | 20 | 10 |
| | | | | | 74C754 | 20 | 40 | 20 |
| | | | | | 80C11 | 20 | 0 | 10 |
| | | | | | MC145041P | 20 | 0 | 10 |
| | | | | | 74C550 | 20 | 0 | 10 |

A15 READOUT SYSTEM BOARD